



**ROHDE & SCHWARZ**

Test and Measurement  
Division

## **Operating Manual**

# **AUDIO ANALYZER**

# **R&S UPL/UPL16/UPL66**

**DC to 110 kHz**

**1078.2008.06/16/66**

**Software version UPL 3.00**

*Volume 2*  
*Operating manual consists of 2 volumes*

Printed in the Federal  
Republic of Germany

Dear Customer,

The Audio Analyzer R&S UPL is abbreviated as UPL.

## Tabbed Divider Overview

### Contents

#### Data Sheets

Safety Instructions

Certificate of quality

EU Certificate of Conformity

List of R & S Representatives

### VOLUME 1

#### Tabbed Divider

- 1 Chapter 1: Preparation for Use
- 2 Chapter 2: Manual Operation
- 3 Index

### VOLUME 2

#### Contents

#### Tabbed Divider

- 4 Chapter 3: Remote Control
- 5 Chapter 4: Maintenance
- 6 Annex A UPL Default Setup
- 7 Index



## Contents

### 1 Preparation for Use

<b>1.1</b>	<b>Putting into Operation.....</b>	<b>1.1</b>
1.1.1	Setting up the Audio Analyzer.....	1.1
1.1.2	Rackmounting.....	1.1
1.1.3	Power Supply.....	1.1
1.1.4	Switching On.....	1.3
1.1.6	Connecting an External Keyboard .....	1.4
1.1.7	Connecting a Mouse.....	1.4
<b>1.2</b>	<b>Fitting Options .....</b>	<b>1.5</b>
1.2.1	Enabling Software Options .....	1.5
1.2.2	Installation of Supplementary Software .....	1.6
1.2.3	Installation of Virtual Drive (RAMDRIVE).....	1.7
<b>1.3</b>	<b>Software Installation .....</b>	<b>1.9</b>
<b>1.4</b>	<b>UPL Start Options.....</b>	<b>1.11</b>
1.4.1	Restarting the UPL Software .....	1.11
1.4.2	Integration of Supplementary Programs .....	1.11
1.4.3	Command Line Parameters of the UPL Software .....	1.12
1.4.4	Immediate Effect of Command line Parameters at Power-Up.....	1.14

### 2 Manual Operation

<b>2.1</b>	<b>Explanations of Front- and Rearpanel Views incl. Key Combinations on the External Keyboard.....</b>	<b>2.3</b>
2.1.1	Front-panel View .....	2.3
2.1.2	Rear-panel View.....	2.11
2.1.3	Block Diagram .....	2.12
<b>2.2</b>	<b>Operating Instructions .....</b>	<b>2.13</b>
2.2.1	Brief Introduction .....	2.13
2.2.2	Introductory Examples.....	2.15
<b>2.3</b>	<b>General Instructions for Use .....</b>	<b>2.29</b>
2.3.1	Panels.....	2.31
2.3.2	Data Entry.....	2.34
2.3.2.1	Selecting a Parameter .....	2.34
2.3.2.2	Entry of Numeric Data .....	2.35
2.3.2.3	Using the Softkeys.....	2.36
2.3.2.4	Help Line.....	2.36
2.3.2.5	Entry of File Names .....	2.36
2.3.2.6	Data Input or Output during Measurements .....	2.39

2.3.3	Display of Measured Values .....	2.40
2.3.4	Settling Process .....	2.41
2.3.4.1	Introduction .....	2.41
2.3.4.2	The Settling Parameters: .....	2.42
2.3.4.3	Settling Process with External Sweep:.....	2.47
2.3.4.4	SETTLING Check and Optimization .....	2.48
2.3.5	Status Display .....	2.51
2.3.6	Error Messages .....	2.53
2.3.7	Help Function.....	2.55
2.3.8	Simplification of Panels.....	2.56
<b>2.4</b>	<b>Units.....</b>	<b>2.57</b>
2.4.1	Units for the Display of Measurement Results .....	2.57
2.4.2	Units for the Entry of Values.....	2.61
<b>2.5</b>	<b>Generators (GENERATOR Panel) .....</b>	<b>2.64</b>
2.5.1	Selecting the Generator .....	2.65
2.5.2	Configuration of Analog Generator.....	2.66
2.5.2.1	Unbalanced Output (Output UNBAL).....	2.68
2.5.2.2	Balanced Output (Output BAL) .....	2.69
2.5.2.3	Output Power .....	2.70
2.5.3	Configuration of the Digital Generator.....	2.71
2.5.3.1	Generating Jitter, Phase and Common Mode .....	2.77
2.5.3.2	AES/EBU Protocol Definition .....	2.78
2.5.4	Functions.....	2.85
2.5.4.1	Common Parameters for Generator Signals.....	2.86
2.5.4.1.1	Common Parameters for SINE, DFD, MOD DIST Signals.....	2.86
2.5.4.1.2	Common Parameters for All Generator Functions .....	2.87
2.5.4.1.3	Equalization of the Signals SINE, SINE BURST, DFD, MULTISINE, RANDOM .....	2.88
2.5.4.1.4	Amplitude Variation of the Signals MULTISINE, RANDOM and ARBITRARY .....	2.89
2.5.4.2	Sweeps .....	2.91
2.5.4.3	SINE.....	2.99
2.5.4.4	MULTISINE.....	2.101
2.5.4.5	SINE BURST .....	2.106
2.5.4.6	SINE <sup>2</sup> BURST .....	2.109
2.5.4.7	MOD DIST (Two-tone Signal to SMPTE) .....	2.111
2.5.4.8	DFD (Difference Frequency Distortion) .....	2.114
2.5.4.9	Random (Pseudo Noise) .....	2.117
2.5.4.10	Arbitrary (User-Programmable Signal) .....	2.124
2.5.4.11	POLARITY (Polarity Test Signal).....	2.127
2.5.4.12	FSK (Frequency Shift Keying) .....	2.127
2.5.4.13	STEREO SINE.....	2.128
2.5.4.14	MODULATION (modulated sine).....	2.132
2.5.4.15	DC Voltage.....	2.133
2.5.4.16	Coded Audio (Coded Audio Signals) .....	2.134

2.5.5	Auxiliary Generator.....	2.138
2.5.5.1	Auxiliary Generator Used as Analog Generator .....	2.139
2.5.5.2	Auxiliary Generator Used as Common Mode Generator.....	2.140
2.5.5.3	Auxiliary Generator Used as Jitter Generator.....	2.140
2.5.5.4	Auxiliary Generator Sweep .....	2.141
<b>2.6</b>	<b>Analyzers (ANALYZER Panel) .....</b>	<b>2.142</b>
2.6.1	Selecting the Analyzer.....	2.142
2.6.2	Configuration of Analog Analyzers .....	2.146
2.6.3	Configuration of Digital Analyzer .....	2.153
2.6.3.1	Measurement of Jitter, Phase and Common Mode.....	2.158
2.6.4	Ways of Starting the Analyzer, Ext. Sweep.....	2.159
2.6.5	Functions.....	2.165
2.6.5.1	Common Parameters of Analyzer Functions.....	2.166
2.6.5.2	RMS (incl. S/N) .....	2.178
2.6.5.3	RMS SELECT (Selective RMS Value).....	2.184
2.6.5.4	PEAK, Q-PEAK (Peak and Quasi-peak Weighting incl. S/N).....	2.196
2.6.5.5	DC.....	2.198
2.6.5.6	THD Measurement .....	2.199
2.6.5.7	THD+N/SINAD Measurement (Total Harmonic Distortion+ Noise) .....	2.203
2.6.5.8	MOD DIST (Modulation Distortion).....	2.212
2.6.5.9	DFD (Difference Frequency Distortion) .....	2.214
2.6.5.10	Wow & Flutter .....	2.217
2.6.5.11	POLARITY (Polarity Test).....	2.219
2.6.5.12	FFT (Spectrum) .....	2.220
2.6.5.13	FILTER SIM.....	2.229
2.6.5.14	Waveform (Display in the Time Domain).....	2.230
2.6.5.15	Protocol Analysis .....	2.234
2.6.5.16	Measurement of Digital Input Amplitude.....	2.234
2.6.5.17	Measurement of Phase between Digital Input and Reference Signal .....	2.234
2.6.5.18	INPUT Display .....	2.235
2.6.5.19	Frequency Measurement.....	2.237
2.6.5.20	Combined Frequency, Phase and Group Delay Measurement .....	2.240
2.6.5.22	Coherence Measurement and Transfer Function.....	2.244
2.6.5.23	Loudspeaker Measurements (RUB & BUZZ) .....	2.246
2.6.5.24	Third Analysis (1/3 OCTAVE).....	2.252
2.6.5.25	12 <sup>th</sup> OCTAVE Analysis (12 <sup>th</sup> OCTAVE).....	2.256
2.6.6	Headphone/Speaker Output.....	2.260
2.6.7	Applications .....	2.266
2.6.7.1	Crosstalk Measurement.....	2.266
2.6.7.2	Linearity Measurements.....	2.268
2.6.7.3	Fast Frequency-Response Measurements.....	2.271
2.6.8	Optimizing the Measurement Speed .....	2.272
1.	Speed Optimization without Affecting Measurement Results.....	2.272
2.	Compromise between Measurement Time and Accuracy or Dynamic .....	2.273
3.	Speed Optimization Through Use of Internal Generator.....	2.274
4.	Optimizing the Speed of Generator Sweeps.....	2.274
5.	Optimized Utilization of DSP Performance with the Clock Rate.....	2.276
2.6.9	Improving the Frequency Response .....	2.277
<b>2.7</b>	<b>Analyzer Filters (FILTER Panel) .....</b>	<b>2.278</b>

2.7.1	Weighting Filters.....	2.279
2.7.2	Creating the User-definable Filters.....	2.284
2.7.2.1	Common Parameters of All Filters.....	2.285
2.7.2.2	Lowpass / Highpass.....	2.286
2.7.2.3	Bandpass / Bandstop.....	2.287
2.7.2.4	Notch.....	2.289
2.7.2.5	Third-octave / Octave.....	2.290
2.7.2.6	Internal Calculation of Filters .....	2.291
2.7.2.7	File-defined Filter ("FILE-DEF") .....	2.292
<b>2.8</b>	<b>STATUS Panel.....</b>	<b>2.293</b>
<b>2.9</b>	<b>Series of Measured Values, Files and Loadable Instrument Settings (FILE Panel)...</b>	<b>2.294</b>
2.9.1	Loading and Storing .....	2.294
2.9.1.1	Loading and Storing of Instrument Setups and Complete Setups .....	2.296
2.9.1.2	Loading and Storing of Series of Measured Values and Block/List Data ....	2.302
2.9.1.3	Format of Block/List Files.....	2.307
2.9.1.4	Editing Limit Files.....	2.312
2.9.1.5	Generating a Limit file from a Trace File.....	2.314
2.9.1.6	Generating a Limit File using an Application Program.....	2.317
2.9.1.7	Limit Report.....	2.317
2.9.2	Editing Files and Directories.....	2.321
2.9.3	Series of Measured Values (Sweeps and Scans) and Block/List Data .....	2.324
2.9.3.1	Scan count =1 .....	2.324
2.9.3.2	Interpolation to a Common X Axis .....	2.325
2.9.3.3	Scan Count >1 .....	2.325
<b>2.10</b>	<b>Graphical Data Presentation (DISPLAY and GRAPHICS Panels).....</b>	<b>2.327</b>
2.10.1	Parameters for Display of Traces and Spectra (DISPLAY Panel).....	2.330
2.10.2	Trace and Spectrum Display (GRAPH panel) .....	2.337
2.10.3	Parameters for the Display of Lists.....	2.344
2.10.4	Display (GRAPH) of Lists.....	2.346
2.10.5	Parameters for BARGRAPH Display .....	2.347
2.10.6	BARGRAPH Display (GRAPHICS Panel).....	2.349
2.10.7	Limit Check.....	2.350
2.10.8	PROTOCOL Analysis .....	2.352
2.10.9	Switching between Full-screen and Part-screen Mode .....	2.357
<b>2.11</b>	<b>Starting and Stopping Measurements or Sweeps.....</b>	<b>2.358</b>
2.11.1	Overview of Measurement and Sweep Systems .....	2.358
2.11.2	Switching Measurement Modes On and Off.....	2.359
2.11.3	Operating States of Measurement System (No Sweep Active) .....	2.360
2.11.4	Overview of Sweep Modes .....	2.361
2.11.5	Switching Sweeps On and Off.....	2.362
2.11.6	Operating States of Sweep System .....	2.363
2.11.7	Operating Modes of External Frequency and Level Sweeps.....	2.367
2.11.8	Several Sweep Traces Displayed in a Diagram.....	2.368



---

<b>2.12</b>	<b>Display of Selected Inputs / Outputs .....</b>	<b>2.370</b>
<b>2.13</b>	<b>Fast Switch-off of Outputs .....</b>	<b>2.371</b>
<b>2.14</b>	<b>Printing / Plotting / Storing the Screen Contents .....</b>	<b>2.371</b>
2.14.1	Screen Copy to Printer (pixel-oriented).....	2.381
2.14.2	Output in HP-GL Format.....	2.383
2.14.3	Output in PCX Format .....	2.383
2.14.4	Output in PostScript Format .....	2.384
2.14.4.1	PostScript Configuration File PS.CFG.....	2.385
2.14.4.2	Integrating and Output of PostScript Files .....	2.387
2.14.5	Output of Measurement Traces and Lists .....	2.389
<b>2.15</b>	<b>Setting and Displaying Auxiliary Parameters (OPTIONS Panel).....</b>	<b>2.390</b>
2.15.1	Selecting the Remote-Control Interface (IEC/IEEE Bus/COM2) .....	2.390
2.15.2	Beeper On/Off.....	2.393
2.15.3	Keyboard Settings.....	2.393
2.15.4	Language of Help Texts.....	2.393
2.15.5	Display Settings .....	2.394
2.15.5.1	Switching the Measurement Display ON/OFF .....	2.394
2.15.5.2	Reading Rate of Measurement Results.....	2.395
2.15.5.3	Resolution of Measurement Results.....	2.395
2.15.5.4	Graphics Display with Selectable Colours .....	2.395
2.15.6	Calibration.....	2.399
2.15.7	Version Display and Service Functions .....	2.401
2.15.8	Transfer of Parameters (Parameter Link Function).....	2.403
2.15.9	Selecting the Sampling Mode .....	2.405
<b>2.16</b>	<b>Macro-Operation.....</b>	<b>2.406</b>
<b>2.17</b>	<b>Connecting External Devices .....</b>	<b>2.408</b>
<b>2.18</b>	<b>UPL Used as Computer.....</b>	<b>2.412</b>
2.18.1	Setting the Realtime Clock .....	2.412

### 3 Remote Control

<b>3.1</b>	<b>Introduction.....</b>	<b>3.1</b>
<b>3.2</b>	<b>First Steps (Read-in of Measured Values) .....</b>	<b>3.3</b>
<b>3.3</b>	<b>Switchover to Remote Control.....</b>	<b>3.4</b>
3.3.1	Setting the Device Address.....	3.4
3.3.2	Indications During Remote Control.....	3.4
3.3.3	Return to Manual Operation.....	3.5
<b>3.4</b>	<b>IEC/IEEE-Bus Messages .....</b>	<b>3.6</b>
3.4.1	Interface Messages .....	3.6
3.4.2	Device-Dependent Messages (Commands and Responses).....	3.6
<b>3.5</b>	<b>Structure and Syntax of Device-Dependent Messages .....</b>	<b>3.7</b>
3.5.1	SCPI Introduction.....	3.7
3.5.2	Command Structure.....	3.7
3.5.3	Structure of a Command Line.....	3.9
3.5.4	Responses to Queries .....	3.11
3.5.5	Types of Parameters .....	3.13
3.5.6	Overview of Syntax Elements.....	3.15
3.5.7	Programming Model of UPL Generator .....	3.16
3.5.8	Programming Model of UPL Analyzer.....	3.17
<b>3.6</b>	<b>Instrument Model and Command Processing .....</b>	<b>3.18</b>
3.6.1	Input Unit.....	3.18
3.6.2	Parser .....	3.19
3.6.3	Setting the Device Hardware .....	3.19
3.6.4	Why is a Specific Operating Sequence Sometimes Required?.....	3.19
3.6.5	Status Reporting System .....	3.21
3.6.6	Output Unit.....	3.21
3.6.7	Triggering a Measurement/Sweep.....	3.21
3.6.8	Command Synchronization.....	3.21
3.6.8.1	Wait for End of Calibration .....	3.22
3.6.8.2	Wait for End of Measurement/Sweep.....	3.22
3.6.8.3	Comparison of Synchronization Capabilities .....	3.24
<b>3.7</b>	<b>Status Reporting System.....</b>	<b>3.24</b>
3.7.1	Structure of SCPI Status Register .....	3.25
3.7.2	Overview of Status Register .....	3.27
3.7.3	Description of Status Registers .....	3.28
3.7.3.1	Status Byte (STB) and Service Request Enable Register (SRE) .....	3.28
3.7.3.2	IST Flag and Parallel Poll Enable Register (PPE) .....	3.29
3.7.3.3	Definition of bits used in the Event Status Register .....	3.29
3.7.3.4	STATus:OPERation Register.....	3.30
3.7.3.5	STATus:QUESTionable Register.....	3.31
3.7.3.6	STATus XQUESTionable Register .....	3.32

3.7.4	Use of Status Reporting System .....	3.33
3.7.4.1	Service Request, Use of Hierarchical Structure .....	3.33
3.7.4.2	Serial Poll .....	3.34
3.7.4.3	Parallel Poll .....	3.34
3.7.4.4	Queries .....	3.35
3.7.4.5	Error Queue Query .....	3.35
3.7.5	Resetting the Status Reporting Systems.....	3.36
<b>3.8</b>	<b>Notation of Command Table .....</b>	<b>3.37</b>
<b>3.9</b>	<b>Common Commands .....</b>	<b>3.39</b>
<b>3.10</b>	<b>IEC/IEEE-Bus Commands.....</b>	<b>3.41</b>
3.10.1	Generators .....	3.41
3.10.1.1	Selection of Generator.....	3.41
3.10.1.2	Configuration of Analog Generators .....	3.41
3.10.1.3	Configuration of Digital Generators .....	3.44
3.10.1.3.1	AES / EBU PROTOCOL Definition.....	3.48
3.10.1.3.2	Auxiliary AUX GEN.....	3.50
3.10.1.4	Generator Sweeps.....	3.52
3.10.1.4.1	Sweep Settings for Auxiliary Generator (AUX GEN).....	3.52
3.10.1.5	Generator Functions.....	3.62
3.10.1.5.1	SINE .....	3.63
3.10.1.5.2	MULTISINE .....	3.65
3.10.1.5.3	SINE BURST .....	3.69
3.10.1.5.4	SINE <sup>2</sup> BURST .....	3.71
3.10.1.5.5	MOD DIST .....	3.73
3.10.1.5.6	DFD .....	3.76
3.10.1.5.7	RANDOM .....	3.79
3.10.1.5.8	ARBITRARY .....	3.83
3.10.1.5.9	POLARITY.....	3.86
3.10.1.5.10	FSK (Frequency shift keying) .....	3.87
3.10.1.5.11	STEREO SINE .....	3.88
3.10.1.5.12	MODULATION (FM or AM signal).....	3.91
3.10.1.5.13	DC voltage.....	3.92
3.10.1.5.14	Coded Audio (Coded Audio Signals).....	3.93
3.10.2	IEC/IEEE-Bus Commands for Analyzers .....	3.97
3.10.2.1	Selection of Analyzer .....	3.97
3.10.2.2	Configuration of Analog Analyzers .....	3.97
3.10.2.3	Configuration of Digital Analyzers.....	3.100
3.10.2.4	Starting the Analyzer, Ext. Sweep .....	3.103
3.10.2.5	Analyzer Functions .....	3.105
3.10.2.5.1	Common Parameters for Analyzer Functions .....	3.106
3.10.2.5.2	RMS Measurement incl. S/N.....	3.108
3.10.2.5.3	Selective RMS Measurement incl. Sweep .....	3.112
3.10.2.5.4	Peak and Quasi-Peak Measurement incl. S/N.....	3.119
3.10.2.5.5	DC Measurement .....	3.122
3.10.2.5.6	THD Measurement.....	3.123
3.10.2.5.7	THD + N / Sinad Measurement.....	3.125
3.10.2.5.8	MOD DIST .....	3.128
3.10.2.5.9	DFD .....	3.129

3.10.2.5.10	Wow & Flutter .....	3.130
3.10.2.5.11	POLARITY .....	3.131
3.10.2.5.12	FFT .....	3.131
3.10.2.5.13	Filter Simulation .....	3.136
3.10.2.5.14	WAVEFORM.....	3.137
3.10.2.5.15	Coherence Measurement and Transfer Function .....	3.140
3.10.2.5.16	Loudspeaker Measurements (RUB & BUZZ) .....	3.142
3.10.2.5.17	Input Level of Digital Signal (DIG INP AMP) .....	3.146
3.10.2.5.18	Phase Measurement (PHAS TO REF) .....	3.147
3.10.2.5.19	PROTOCOL.....	3.147
3.10.2.5.20	INPUT DISP .....	3.148
3.10.2.5.21	Frequency Measurement .....	3.150
3.10.2.5.22	Combined Frequency, Phase and Group-Delay Measurement .....	3.151
3.10.2.5.23	Sample Rate Measurement .....	3.154
3.10.2.5.24	Terzanalyse .....	3.156
3.10.2.5.25	12th Octave Analysis (12th OCTAVE) .....	3.160
3.10.3	Selection of Analyzer Filter .....	3.163
3.10.4	Units for IEC/IEEE Measurement Results .....	3.171
3.10.5	Loading and Storing.....	3.177
3.10.5.1	Loading and Storing Instrument Setups .....	3.177
3.10.5.1.1	Loading and Storing Traces and Lists .....	3.179
3.10.5.1.2	Storing Limit Violations (Error Reports) .....	3.180
3.10.5.1.3	Storing Equalization Files .....	3.181
3.10.5.2	Commands for Editing Files and Directories .....	3.182
3.10.6	Commands for Graphical Representation of Results .....	3.183
3.10.6.1	Commands for Limit Check .....	3.193
3.10.6.2	PROTOCOL Analysis .....	3.195
3.10.7	Commands for Printing/Plotting of Screen and Storing in Files.....	3.197
3.10.8	Setting and Display of Auxiliary Parameters .....	3.207
3.10.8.1	IEC/IEEE-Bus Address .....	3.207
3.10.8.2	Switching the Beeper On/Off .....	3.207
3.10.8.3	MACRO Operating .....	3.208
3.10.8.4	Transfer of Settings .....	3.209
3.10.8.6	Parameters of COM2 Interface .....	3.211
3.10.8.7	Keyboard Settings .....	3.212
3.10.8.8	Display Settings .....	3.213
3.10.8.9	Version Display .....	3.217
3.10.8.10	Calibration.....	3.219
3.10.8.11	Loading Speed f. Setups a. Analyzer Measurement Functions.....	3.220
3.10.9	Commands for Data Output .....	3.221
3.10.10	Commands for Input/Output of Block Data.....	3.222
3.10.11	Commands for Status and Error Queries .....	3.229
3.10.12	Commands for Synchronization .....	3.232
3.10.14	Settings without Corresponding IEC/IEEE-Bus Command .....	3.234

<b>3.11</b>	<b>Alphabetical List of IEC/IEEE-Bus Commands</b> .....	<b>3.235</b>
<b>3.12</b>	<b>IEC/IEEE-Bus Interface</b> .....	<b>3.293</b>
3.12.1	Interface Characteristics .....	3.293
3.12.2	Bus Lines .....	3.293
3.12.3	Interface Functions .....	3.294
<b>3.13</b>	<b>Interface Messages</b> .....	<b>3.295</b>
3.13.1	Common Commands.....	3.295
3.13.2	Addressed Commands .....	3.295
<b>3.14</b>	<b>List of Error Messages</b> .....	<b>3.296</b>
3.14.1	SCPI-Specific Error Messages .....	3.296
3.14.2	Command Error .....	3.297
3.14.3	Execution Error .....	3.298
3.14.4	Device-Specific Error .....	3.299
3.14.5	Query Error .....	3.299
3.14.6	UPL-Specific Error Messages.....	3.299
<b>3.15</b>	<b>Examples of IEC/IEEE-Bus Programming (Hints and Program Examples)</b> .....	<b>3.300</b>
3.15.1	R&S BASIC.....	3.300
3.15.2	IEC/IEEE-Bus Control after Power-Up .....	3.300
3.15.3	Command Logging - Converting UPL-B10 Commands into IEC/IEEE-Bus Commands.....	3.300
3.15.4	Initialization and Default Status.....	3.302
3.15.5	Sending Instrument Setting Commands.....	3.302
3.15.6	Switchover to Manual Control.....	3.302
3.15.7	Readout of Instrument Settings .....	3.302
3.15.8	Readout of Measurement Results .....	3.303
3.15.8.1	Readout of Triggered Measurements.....	3.304
3.15.8.2	Readout of Non-Triggered Measurements .....	3.305
3.15.9	Sweep Setting/Trigger .....	3.305
3.15.9.1	Generator Sweep.....	3.305
3.15.9.2	External Sweep.....	3.306
3.15.9.3	RMS-Selektiv-Sweep.....	3.306
3.15.10	Tuning - Setup for Maximum Measurement Speed.....	3.307
3.15.10.1	Configuration for Maximum Measurement Speed.....	3.307
3.15.10.2	Adapting Measurement Speed to Signal Frequency.....	3.307
3.15.10.3	Configuration for Maximum Sweep Speed.....	3.309
3.15.10.3.1	Generator Sweep .....	3.309
3.15.10.3.2	External Sweep .....	3.310
3.15.10.3.3	RMS Selective Sweep .....	3.310
3.15.10.3.4	Measurement Speed with Reference to Sampling Mode.....	3.312
3.15.11	List Management.....	3.312
3.15.11.1	Loading Lists into the UPL.....	3.312
3.15.11.1.1	Loading Sweep Lists into the UPL .....	3.312
3.15.11.1.2	Loading and Display of Several Traces in the UPL.....	3.312
3.15.11.1.3	Loading and Displaying of Trace Pairs in the UPL.....	3.313
3.15.11.2	Readout of Data Lists from the UPL.....	3.314
3.15.11.2.1	Readout of Lists of up to 1024 Values .....	3.315

3.15.11.2.2	Readout of FFT Lists of more than 1024 Values .....	3.315
3.15.11.2.3	FFT Lists with Suppressed Noise Floor .....	3.317
3.15.11.2.4	Readout of Several Traces from UPL .....	3.317
3.15.11.2.5	Readout of Trace Pairs from UPL .....	3.318
3.15.12	Filter Settings.....	3.319
3.15.13	Finding a File .....	3.320
3.15.14	Readout of Error Queue .....	3.320
3.15.15	Command Synchronization .....	3.320
3.15.15.1	Command Synchronization with *WAI.....	3.321
3.15.15.2	Command Synchronization with *OPC?.....	3.321
3.15.15.3	Command Synchronization with *OPC and SRQ .....	3.321
3.15.16	Service Request .....	3.322
3.15.16.1	SRQ Interrupt Routine with Serial Poll.....	3.322
3.15.16.1.1	Initialization of Serial Poll SRQ .....	3.322
3.15.16.1.2	Serial Poll SRQ Routine .....	3.323
3.15.16.2	SRQ Interrupt Routine with Parallel Poll.....	3.324
3.15.16.2.1	Initialization of Parallel Poll SRQ .....	3.324
3.15.16.2.2	Parallel Poll SRQ Routine .....	3.324
3.15.17	Readout of Cursor Position and Values .....	3.325
3.15.18	Call a BASIC-Macro.....	3.329
3.15.19	Third analysis - Output of Block Data .....	3.333
<b>3.16</b>	<b>Automatic Control of UPL with R&amp;S BASIC.....</b>	<b>3.337</b>
3.16.1	Use.....	3.337
3.16.2	Scope of Functions .....	3.337
3.16.3	Preparation for Use.....	3.338
3.16.4	Operation .....	3.339
3.16.4.1	Switchover between UPL and BASIC Entry Mode.....	3.339
3.16.4.2	First Steps (Readout of Measurement Results) .....	3.340
3.16.4.3	Logging Mode .....	3.340
3.16.4.4	Differences to IEC/IEEE-Bus Remote Control .....	3.341
3.16.4.5	UPL-Specific Modifications to the BASIC Manual .....	3.346
3.16.4.6	BASIC Screen.....	3.348
3.16.4.7	Control Commands Unsuitable for Logging .....	3.349
3.16.4.8	Driver for Screen and Keyboard STRINX.SYS.....	3.350
3.16.4.9	Operation of Serial Interfaces COM1 and COM2 .....	3.354
3.16.4.10	UPL-Specific Error Messages From BASIC .....	3.355
3.16.4.11	UPL/BASIC Memory Management.....	3.356
<b>3.17</b>	<b>Remote Control via RS-232 Interface .....</b>	<b>3.357</b>
3.17.1	Preparation for Use.....	3.357
3.17.2	Switchover to Remote Control .....	3.358
3.17.3	Return to Manual Operation.....	3.358
3.17.4	First Steps (Readout of Measurement Results) .....	3.358
3.17.4.1	Readout of Measurement Results in QuickBASIC .....	3.359
3.17.4.2	Readout of Measurement Results in R&S BASIC .....	3.360
3.17.4.3	Readout of Measurement Results in Borland-C 3.0 .....	3.361
3.17.5	Binary Data via RS232 Interface .....	3.363
3.17.6	Differences to Remote Control via IEC/IEEE Bus .....	3.364

---

<b>4</b>	<b>Maintenance and Troubleshooting .....</b>	<b>4.1</b>
<b>4.1</b>	<b>Maintenance.....</b>	<b>4.1</b>
4.1.1	Mechanical Maintenance.....	4.1
4.1.2	Electrical Maintenance .....	4.1
<b>4.2</b>	<b>Function Test .....</b>	<b>4.1</b>
<b>4.3</b>	<b>Troubleshooting .....</b>	<b>4.2</b>
4.3.1	BIOS-SETUP.....	4.2
4.3.2	Others.....	4.5
<b>5</b>	<b>UPL Default Setup</b>	
<b>A.1</b>	<b>Default Settings of Generator.....</b>	<b>A.1</b>
<b>A.2</b>	<b>Default Settings of Analyzer.....</b>	<b>A.13</b>
<b>A.3</b>	<b>Default Settings of Filter Panel .....</b>	<b>A.21</b>
<b>A.4</b>	<b>Default Settings of Display Panel .....</b>	<b>A.22</b>
<b>A.5</b>	<b>Default Settings of Options Panel.....</b>	<b>A.23</b>
<b>A.6</b>	<b>Default Settings of File Panel .....</b>	<b>A.25</b>
<b>6</b>	<b>Index</b>	





## 3 Remote Control

### 3.1 Introduction

- UPL may be equipped with option UPL-B4 permitting remote control via an IEC/IEEE-bus interface to IEC 625.1/IEEE 488.2 standard and an
- RS-232 interface at the COM2 port.

In addition, UPL may be equipped with option UPL-B10 permitting sequence control for automatic measurements.

**Note:**

*The sections below mainly describe remote control via the IEC/IEEE-bus interface but most of them also applies to **remote control via the RS-232 interface** and the **Universal Sequence Controller UPL-B10**. If this is not the case reference will be made to the applicable section.*

**Note:**

*If the remote-control option UPL-B4 was not originally ordered with the UPL, it may be obtained via the local sales engineer (for Order No. see data sheet). After entering an enable code as described in the supplied instructions, the IEC/IEEE-bus option and the RS-232 interface are ready for use without any additional hardware installations being required.*

**Note:**

*If the remote control option UPL-B4 is not enabled, UPL should not be connected to other instruments via the IEC/IEEE bus as in this case problem-free operation cannot be guaranteed.*

The connectors for the IEC/IEEE-bus and the RS-232 interface (COM2) are located at the rear of the instrument. They allow a controller to be connected for remote control. The instrument supports SCPI version 1993.0 (Standard Commands for Programmable Instruments). The SCPI standard is based on standard IEEE 488.2 and aims at the standardization of device-specific commands, error handling and status registers (see section 3.5.1 SCPI Introduction).

**Note:**

*In the IEC/IEEE-bus command lists given below, all commands confirmed or approved by the SCPI committee are written in normal characters. Other innovative commands or commands required for general measurements are in italics and in the form and style as specified by SCPI (not part of SCPI definition).*

This section assumes a basic knowledge of IEC/IEEE-bus programming and controller operation. A description of the interface commands is to be obtained from the relevant manuals.

The requirements of the SCPI standard placed on command syntax, error handling and configuration of status registers are explained in detail in the respective sections. Tables provide a fast overview of the bit assignment in the status registers. The tables are supplemented by a comprehensive description of the status registers. For detailed program examples of the main functions see **3.15 Examples of IEC/IEEE-Bus Programming**.

All program examples for IEC/IEEE-bus control are written in R&S BASIC, likewise all program examples in the UPL software in the paths

C:\UPL\IEC EXAM\EXAM1.BAS ff and  
C:\UPL\B10 EXAM\EXAM1.BAS ff.

Examples C:\UPL\IEC EXAM\EXAM1.BAS ff can be directly run on a controller using a suitable IEC/IEEE-bus card and R&S BASIC. Files with the extension .SAC are setup files required by the program examples for setting the UPL. Files with the extension .TXT provide the program code of the examples as an ASCII file and can be accessed by any editor.

Examples C:\UPL\B10 EXAM\EXAM1.BAS ff can be run on an UPL using the Universal Sequence Controller UPL-B10. Meaning of files with the extensions .SAC and .TXT as described above.

### 3.2 First Steps (Read-in of Measured Values)

The short and simple operating sequence below permits rapid setup of the instrument and of its basic functions.

A condition is, however, that the **IEC/IEEE-bus address**, which is factory-set to **20**, is not changed.

Program example:

Triggering 10 measurement results and display on the screen.

1. Interconnect instrument and controller using the IEC/IEEE-bus cable.

2. Write the following program on the controller and start it with RUN (F2):

```

10 IEC TERM 10: '      Controller expects LF as a delimiter of an UPL reply
20 IEC TIME 5000:      'Controller waits max. 5 s for a reply from
30 '                  UPL before sending an IEC/IEEE-bus timeout
40 IEC OUT 20,"*RST": '      UPL default setup
45 IEC OUT 20,"INP:TYPE GEN2": ' Internal connection to generator channel 2
50 IEC OUT 20,"*CLS": '      Resets IEC/IEEE-bus status register
60 FOR I = 1 TO 10
70 IEC OUT 20,"INIT:CONT OFF;*WAI": '      Triggers a single measurement
80 IEC OUT 20,"SENS:DATA?": '      Requests a measurement result
90 IEC IN 20, M$:      'Read-in of measurement result
100 PRINT M$:          'Output of measurement result
110 NEXT I
120 END

```

As a result of the default setup with \*RST (see annex A UPL Default Setup in the UPL manual), the UPL generator produces a 1-kHz sinewave signal with a level of 0.5 V.

Command INP:TYPE GEN2 establishes an internal connection between generator channel 2 and analyzer channel 1 so that no cabling of outputs and inputs is required for this first test. The UPL analyzer carries out 10 RMS measurement, indicates the measurement results in the display and outputs them continuously on the controller display.

**Note:**

*A measurement result must be triggered before it can be displayed on the screen (line 70). The settled result available after triggering can be requested (line 80), read-in (line 90) and output to the controller display (line 100).*

3. Press the [LOCAL] key on the front panel to return to manual operation.

Universal Sequence Controller (UPL-B10)	RS-232 interface
See 3.16.4.2 First Steps (Readout of Measurement Results)	See 3.17.4 First Steps (Readout of Measurement Results)

### 3.3 Switchover to Remote Control

After power-on, the instrument is always in the manual operating state (LOCAL state) and can be operated from the front panel or the keyboard. It is switched to remote control (REMOTE state shown by REMOTE caption in the screen center) as soon as it receives an addressed command from a controller.

If the UPL has been set to the manual status from REMOTE with the LOCAL key, then each command via

**R&S BASIC** switches the UPL to the REMOTE status, because R&S BASIC sends each command in addressed form to the UPL. If the

**NI GPIB device driver** is used, the first IEC/IEEE command should be send addressed. This addressing for board-specific programming is for example the command `ibcmd (board address, 20, 1)` or for device-specific programming the **repeat addressing** setting in the NI GPIB device driver – or `ibloc(0)` before the first IEC/IEEE command. If the UPL in the LOCAL state is sent a non-addressed command, the latter will be carried out but the screen will show the old manual settings and not the expected empty screen with the REMOTE caption.

During remote control, operation from the front panel is disabled. The instrument remains in the remote state until it is reset to manual operation via the front panel or the IEC/IEEE bus (see section 3.3.3 Return to Manual Operation). Switching from manual operation to remote control and vice versa has no effect on the instrument setup.

Universal Sequence Controller (UPL-B10)	RS-232 interface
See 3.16.4.1 Connection Basic-UPL	3.17.2 Switchover to Remote Control

#### 3.3.1 Setting the Device Address

The IEC/IEEE-bus address of the instrument is factory-set to 20. It can be changed manually under UPL IECadr in the OPTIONS panel or via the IEC/IEEE bus.

**Manually:** Enter the required address under **UPL IECadr** in the OPTIONS panel.

**Via IEC/IEEE bus:**

```
IECOUT 20,"SYST:COMM:GPIB:ADDR 30":'          Set new address 30
HOLD 500:'          Wait approx. 500 ms before new commands are effected
```

Universal Sequence Controller (UPL-B10)	RS-232 interface
Not applicable	Not applicable

#### 3.3.2 Indications During Remote Control

- The remote-control status is signalled by the word REMOTE in the display center and by the REM LED on the UPL front panel.
- Measurement results (active) are indicated in the upper part of the display.
- Error messages occurring during IEC/IEEE-bus control are displayed in plain text in the lower part of the UPL display (see also section 3.14 List of Error Messages).

### 3.3.3 Return to Manual Operation

Return to manual control can be made from the front panel or via the IEC/IEEE bus.

**Manual:** Press the [LOCAL] key, the REM LED goes out.

Prior to the switchover, command processing must be completed as otherwise remote control is immediately switched on again.

**Note: LLO state (Local Lockout):**

The [LOCAL] key can be locked by the universal command LLO in order to prevent inadvertent switchover:

**R&S-BASIC:**

R&S BASIC command IECLLO

**NI-GPIB-Treiber:**

NI command SendLLO(0)

This state can be cancelled only by switching the "REN" line of the IEC/IEEE bus from 0 to 1:

**R&S-BASIC:**

R&S BASIC commands IECNREN, followed by IECREN.

**NI-GPIB-Treiber:**

NI commands ibsre(0,0); followed by ibsre(0,1);

**Via IEC/IEEE bus:**

**R&S-BASIC:**

```

:
IECLAD 20: '           Sets device to manual operation
IECGTL
:
    
```

**NI-GPIB-Treiber:**

ibloc (0);

To switch UPL from LOCAL state to REMOTE state, see 3.3 Switchover to Remote Control

Universal Sequence Controller (UPL-B10)	RS-232 interface
See 3.16.4.1 Connection Basic-UPL	3.17.3 Return to Manual Operation

## 3.4 IEC/IEEE-Bus Messages

The messages transmitted on the data lines of the IEC/IEEE bus can be subdivided into two groups:

- **interface messages** and
- **device-dependent messages**

### 3.4.1 Interface Messages

Interface messages are transmitted on the data lines of the IEC/IEEE bus, with the control line "ATN" being active. They are used for communication between the controller and the instrument and can only be sent by a controller with controller function on the IEC/IEEE bus.

There are two groups of interface messages:

- **common commands** and
- **addressed commands**

See 3.13.1, Universal Commands and 3.13.2, Addressed Commands

Common commands affect all devices connected to the IEC/IEEE bus without any addressing being required, whereas addressed commands only affect devices addressed as a listener. The relevant interface messages for the UPL are listed in annex A.

Universal Sequence Controller (UPL-B10)	RS-232 interface
Not applicable	Not applicable

### 3.4.2 Device-Dependent Messages (Commands and Responses)

The device-dependent messages are transmitted on the data lines of the IEC/IEEE bus, with the control line ATN being not active. The ASCII code is used for data transmission. Device-dependent messages are differentiated according to the direction in which they are sent via the IEC/IEEE bus:

- **Commands** are messages sent by the controller to the UPL. They control the device functions and request information.  
The commands are subdivided according to two criteria:
  1. According to the effect they have on the device:
    - Setting commands** cause device settings to be made, e.g. the resetting of the UPL or the setting of the output level to 1 Volt.
    - Queries** cause data to be provided for output via the IEC/IEEE bus, eg for device identification or query of the active input.
  2. According to their definition in the IEEE 488.2 standard:
    - Common commands** are precisely defined in their function and notation in the IEEE 488.2 standard. They refer to functions as for instance the management of the standardized status registers, resetting and selftest
    - Device-specific commands** refer to functions that depend on the device characteristics, such as frequency setting. A large number of these commands has also been standardized by the SCPI Consortium (see section 3.5.1 SCPI Introduction)
- **Responses** are messages sent by the UPL to the controller following a query. They may contain results, device settings or information on the device status (see section 3.5.4 Responses to Queries).

The section below describes structure and syntax of device-dependent messages. As from section **3.10 IEC-bus Commands** onwards, the commands are listed independent of their function, described in brief and listed in alphabetical order.

## 3.5 Structure and Syntax of Device-Dependent Messages

### 3.5.1 SCPI Introduction

SCPI (Standard Commands for Programmable Instruments) describes a standardized command set for the programming of instruments regardless of the type of instrument or manufacturer. The goal of the SCPI Consortium is to standardize device-specific commands to a large extent. For this purpose an instrument model has been developed which defines identical functions within an instrument or of different instruments. Command systems have been generated and assigned to these functions so that it is possible to address identical functions by the same commands. The command systems have a hierarchical structure. Fig. 3-1 shows this tree structure, using a detail from the SOURce command system for controlling the signal sources of the instrument. The other examples of syntax and structure of the commands are taken from this command system.

SCPI is based on the IEEE 488.2 standard, ie it uses the same syntax elements as well as the "common commands" defined therein. The syntax of the responses is partly subjected to stricter rules than laid down in the IEEE 488.2 standard).

### 3.5.2 Command Structure

The commands consist of a so-called header and usually one or several parameters. Header and parameters are separated by a "white space" (ASCII code 0 to 9, 11 to 32 decimal, eg space). The headers may be composed of several keywords. The query form is generated by appending a question mark directly to the header.

**Common Commands** Common commands consist of a header preceded by an asterisk "\*" and one or several parameters.

Examples	"*RST"	RESET, resets the UPL
	"*ESE 253"	EVENT STATUS ENABLE, sets the bits of the Event Status Enable Registers
	"*ESR?"	EVENT STATUS QUERY, queries the contents of the Event Status Register.

Universal Sequence Controller (UPL-B10)	RS-232 interface
Common commands to be used can be looked up in Table 3.9 <b>Common Commands</b> .	

### Device-specific commands

**Hierarchy** Device-specific commands have a hierarchical structure (see Fig. 3-1). The various levels are represented by compound headers. Headers of the highest level (root level) have one keyword only. This keyword stands for a whole command system.

Example: SENSE This keyword denotes the command system SENSE (see section 3.5.7 Programming Model of UPL Generator)

For lower-level commands the full path has to be specified, starting with the highest level in the left-most position. The individual keywords are separated by a colon ":".

Example: "SENSe:FUNction:SETTling:MODE EXPonential"  
(exponential settling of function test results)

This command is at the fourth level of the SENSe system. It selects the function settling mode.

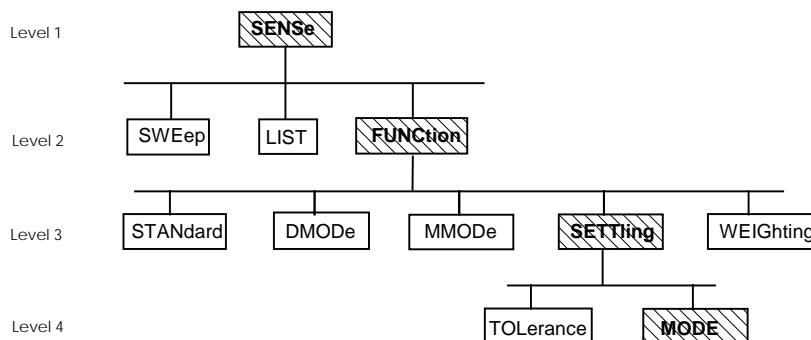

Fig. 3-1 Tree structure of SCPI command system, SENSe being shown as an example

#### Optional keywords:

Some command systems permit certain keywords to be optionally inserted into the header or omitted. In the manual these keywords are marked by square brackets. For reasons of compatibility with the SCPI standard, the instrument must be able to recognize the full command length. Some of the commands become considerably shorter when the optional keywords are omitted.

Example: "DISPlay[:WINDow]:TEXT[:DATA] 'String'"

The following command has the same effect:

"DISPlay:TEXT 'String'" (text in graphic display)

#### Long and short form:

The keywords have a long and a short form. The short form or the long form can be entered, other abbreviations are not permissible

Example: "STATus:QUESTionable:ENABle 1"

The following command has the same effect:

"STAT:QUES:ENAB 1" (0 bit of Status Questionable Register enabled)

#### Note:

*The short form uses uppercase characters, the long form gives the whole keyword. Uppercase and lowercase letters are used for identification in the manual, the UPL itself does not differentiate between uppercase and lowercase characters.*

#### Parameter:

The parameter must be separated from the header by a "white space". If a command contains several parameters, they have to be separated by a comma ",". Some of the queries permit the parameters MINimum and MAXimum to be entered. For a description of the various types of parameter see section 3.5.5 Types of Parameters.

Example: "SENSe:FREQuency:STARt? MAXimum"

**Response:** 21641.8

(query requesting the maximum value for starting a frequency sweep)

#### Numeric suffix:

If a device has several identical functions or features, eg inputs, the desired function can be selected by a suffix added to the command.

Example: "SENSe2:Voltage:REFerence 1V"

(reference value for a relative INPUT peak measurement)

**Note:** Entries without suffix are interpreted like entries with suffix 1



### 3.5.3 Structure of a Command Line

The UPL can process IEC/IEEE-bus commands containing up to 240 characters. If this length is exceeded, an error message is output.

A command line may take up more than one line on the controller display. The end of a line is determined by a delimiter.

#### Delimiters for a command set to the UPL:

A command line to the UPL may contain one or several commands. It is terminated by a <New Line> (ASCII code, 10 decimal) or <EOI> (EOI line active) together with the last useful character of the command line or by <New Line>. Since a <Carriage Return> character (ASCII code, 13 decimal) as a filler before the delimiter has no effect, the combination <Carriage Return><New Line> is permissible.

#### Example for generating the various delimiter combinations:

<Carriage Return>+<New Line>+<EOI> (default setting of IEC/IEEE-bus controller):

```
10 IECEOI
```

```
20 IECOUT 20, "XYZ"
```

If no ';' is sent at the line end, <CR><NL> is added.

<New Line>+<EOI>:

```
10 IECEOI
```

```
20 IECOUT 20, "XYZ"+CHR$(10);
```

',' ensures that no <CR><NL> is added.

<EOI>:

```
10 IECEOI
```

```
20 IECOUT 20, "XYZ";
```

',' ensures that no <CR><NL> is added.

<New Line>:

```
10 IECNEOI
```

```
20 IECOUT 20, "XYZ"+CHR$(10);
```

',' ensures that no <CR><NL> is added.

<Carriage Return>+<New Line>:

```
10 IECNEOI
```

```
20 IECOUT 20, "XYZ"
```

If no ';' is sent at the line end, <CR><NL> is added.

Universal Sequence Controller (UPL-B10)	RS-232 interface
User cannot influence the delimiter.	See 3.17.6 Differences to Remote Control via IEC/IEEE Bus

**Sequencing of commands:**

**Commands may be lined up unless they exceed 240 characters in length.**

Several commands in a command line are separated by a semicolon ";". If the next command belongs to a different system, the semicolon is followed by a colon ":"

Example:

```
IECOUT 20, "SOUR:FREQ:STAR 20Hz;:SYST:BEEP:STAT ON"
(switches on beeper for error messages)
```

This command line contains two commands. The first command belongs to the *SOURCE* system and is used to set the start frequency for a generator sweep. The second command is part of *SYSTEM* and switches on an acoustic alarm in the case of errors.

If the successive commands belong to the same system and therefore have one or several common levels, the command line may be shortened. The second command following the semicolon then starts at the level that is below the common levels (see also Fig. 3-1). The colon after the semicolon has to be omitted.

Example:

```
IECOUT 20, "SOUR:FREQ:STAR 20Hz;:SYST:BEEP:STAT ON"
(Start- and stop command for sweep)
```

This command line is shown in full length and contains two commands separated by a semicolon. Both commands belong to the *SOURCE* command system, *FREQUENCY* subsystem, ie they have two common levels.

In the shortened command line the second command starts at the level below *SOURCE:FREQ*. The colon after the semicolon has to be omitted.

The abbreviated form of the command line is:

```
IECOUT 20, "SOURCE:FREQ:STAR;STOP 15kHz"
```

A new command line always begins with the complete path.

Example: 

```
IECOUT 20, "SOUR:FREQ:START 20Hz"
IECOUT 20, "SOUR:FREQ:STOP 15 kHz"
(Start- and stop command for sweep)
```

When common commands starting with an asterisk "\*" are linked in a command string, they are preceded by a semicolon ";" and not by ";:" as is the case with linked UPL commands.

Example: 

```
IECOUT 20, "INIT;*WAI;:SENS:DATA1?"
```

↑

(triggers measurement, selects result of function measurement on channel 1 and sends next command only after completion of the measurement!)



6. Character strings are output in the same way as they are input, ie the simple and double quotation marks are also output (see section 3.5.6 Overview of Syntax Elements).

Example: **Setting:** "MMEMory:STORe:STATe 2, 'LASTSAVE.SCO' "  
**Query:** "MMEMory:STORe:STATe? 2" **Response:** 'LASTSAVE.SCO'  
 (storage of UPL setting under 'LASTSAVE.SCO')

7. Data blocks are output as ASCII characters or in binary form depending on the IEC/IEEE-bus commands FORM ASC and FORM REAL.

Example:  
 Five floating-point values in the form of a trace are available after a sweep.

**Setting:** "FORM ASC"  
**Query:** "TRACe? TRACe" **Response:** 1.1,1.2,1.3,1.4,1.5  
 (load Y values of curve A into the UPL)

**Setting:** "FORM REAL"  
**Query:** "TRACe? TRACe"

The **response** is sent as a binary data stream. Floating-point values are 4 bytes long and output in the IEEE format (LSB first):

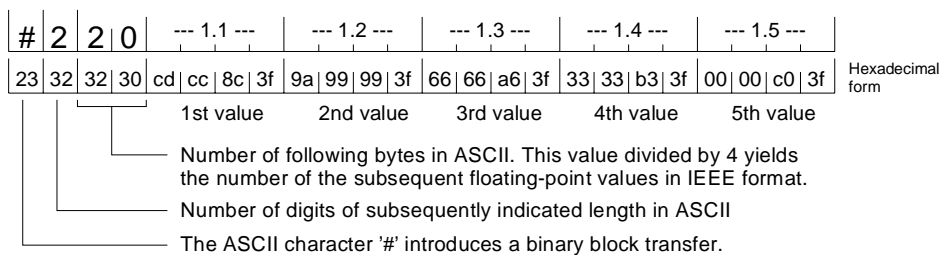

To receive the binary data stream in its full length, set **EOI** (in R&S-BASIC: **IEC TERM 1**) in the controller program and not LF (0Ah = 10d) (in R&S-BASIC: **IEC TERM 10**) as would normally be set for the reception of ASCII strings. This is to avoid the binary data stream being interrupted if the bit combination 0Ah occurs.

Universal Sequence Controller (UPL-B10)	RS-232 interface
See 3.16.4.4 Differences from the IEC-bus Syntax - UPL-B10	See 3.17.6 Differences to Remote Control via IEC/IEEE Bus

### 3.5.5 Types of Parameters

Most commands require the specification of a parameter. The parameters must be separated from the header by a "white space" (ASCII code, 0 to 9, 11 to 32 decimal, generally a blank). Parameters may be specified as numeric values, Boolean parameters, character data, character strings and block data. The type of parameter required for the specific command as well as the permitted range of values are described together with the commands (see section **3.10 IEC-bus Commands**).

**Numeric values** Numeric values may be entered in any customary form, ie with sign, decimal point and exponent. If the values exceed the resolution of the UPL, they will be rounded off. The number including the exponent may comprise up to 20 characters. The number of digits of mantissa and exponent is only limited by this condition. The exponent is denoted by an "E" or "e". The exponent alone must not be used. Physical quantities may be stated with the unit. Permissible prefixes for the unit (also called engineering) are M (Mega), K (Kilo), m (milli) and u (micro). The units for which these prefixes may be used can be seen from the tables in section **2.4 Units** in the UPL manual. With no unit stated, the basic unit is assumed (see section **3.10 IEC-bus Commands** column Basic unit of UPL manual).

Examples:

```
"SOURCE:FREQUENCY 1.5 kHz"      1500 Hz
                                1.5E3      1.5E+3
                                1.5E 3     1.5E 03
                                +1.5E3     001.5E3
```

#### Special numeric values

The parameters MINimum, MAXimum, UP and DOWN are interpreted as special numeric values.

MIN/MAX MINimum and MAXimum denote the minimum and maximum value. Upon a query the numeric value will be returned.

Example: Setting command: "SOURCE:VOLTage MAXimum"  
 Query: "SOURCE:VOLTage?" **Response: 24**  
 (maximum generator level)

UP/DOWN UP increments, DOWN decrements the current numeric value by 0.001%.

NAN **Not A Number** represents the value 9,91E37, is only sent as a device response and denotes missing or illegal values.

**Boolean parameter** Boolean parameters represent two states. The on state (true condition) is represented by ON, the off state (false condition) by OFF.

Example: Setting command: "SENS:FUNC:WEIG ON"  
 Query: "SENS:FUNC:WEIG?" **Response: ON**  
 (W&F weighting filter on)

**Character data** Character data follow the syntax rules for keywords, ie they also have a short and a long form. Like any other parameter, they must be separated from the header by a 'white space'. A query returns the short form of the character data.

Example: Setting command: "DISPlay:MODE COLB"  
 Query: "DISPlay:MODE?" **Response: COLB**  
 (Coloured representation on internal and external display)

**Character string** According to SCPI strings must always be given in single or double quotation marks. Normally single quotes are used as the double quotes are used for identifying the total IEC/IEEE-bus command as a string.

Example: "MMEMory:DELete 'C:\UPL\USER\MYSETUP.SCO'"  
(clearing of specified file)

**Data strings** Numeric values are to be separated by commas, decimal digits by a '.'.

Example: "TRAC LIST1 , 100.0 ,1000.0 ,5000.0 ,15000.0"  
(setting the X values in a graphics display)  
"SOUR:LIST:FREQ 1.1,1.2,1.3,1.4,1.5"  
(setting the frequencies for a frequency sweep)

Whether the data strings start with a comma or a blank depends on the command and is defined by SCPI.

### 3.5.6 Overview of Syntax Elements

The following list provides an overview of the syntax elements..

- :** The colon separates the keywords of a command.  
In a command line, the colon following a semicolon identifies the highest command level.
  
- ;** The semicolon separates two commands in a command line. It does not change the path.
  
- ,** The comma separates several parameters of a command.
  
- ?** The question mark forms a query.
  
- \*** The asterisk identifies a common command.
  
- "** Quotation marks denote the beginning of a character string and terminate it.
  
- #** The double cross denotes the beginning of block data.
  
- A "white space" (ASCII code 0 to 9, 11 to 32 decimal, eg space) separates header and parameter.
  
- .** Decimal point of numeric values.

3.5.7 Programming Model of UPL Generator

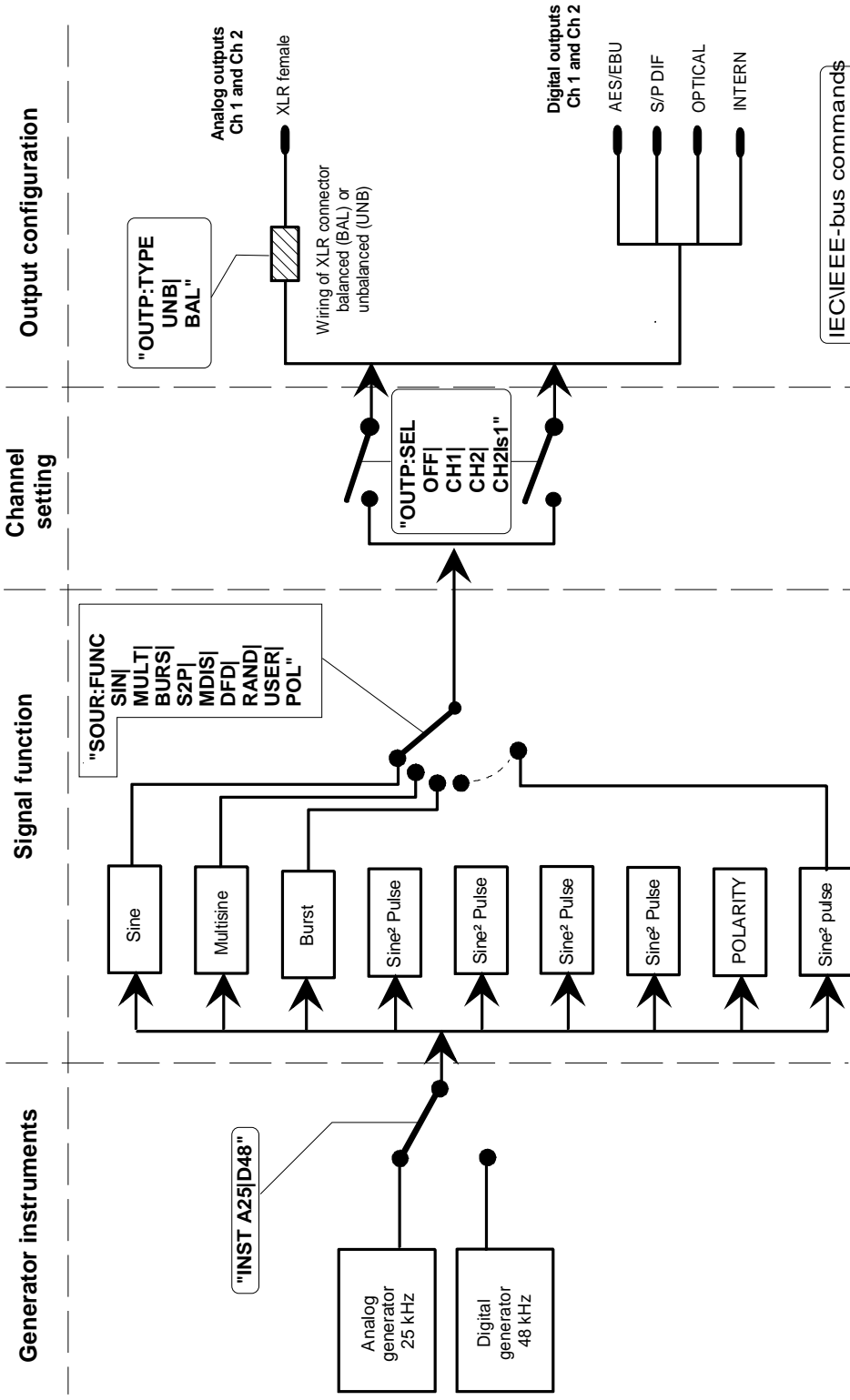

Fig. 3-2 Instruments and signal functions of UPL generator



### 3.5.8 Programming Model of UPL Analyzer

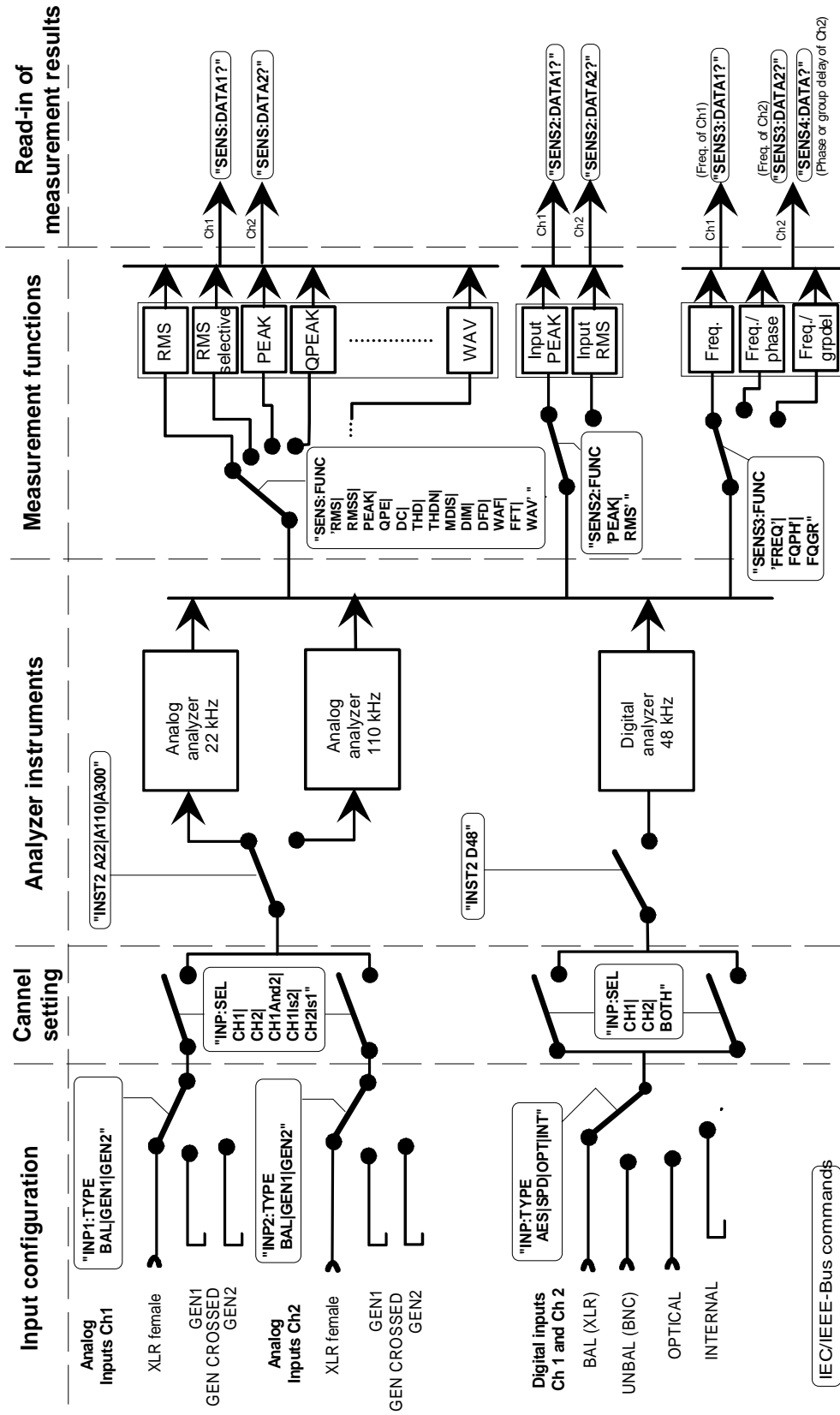

Fig. 3-3 Instruments and measurement functions of UPL analyzer

### 3.6 Instrument Model and Command Processing

The instrument model shown in the following figure has been configured under the aspect of processing IEC/IEEE-bus commands. The individual components operate independently of each other and simultaneously. They communicate with each other by means of so-called messages.

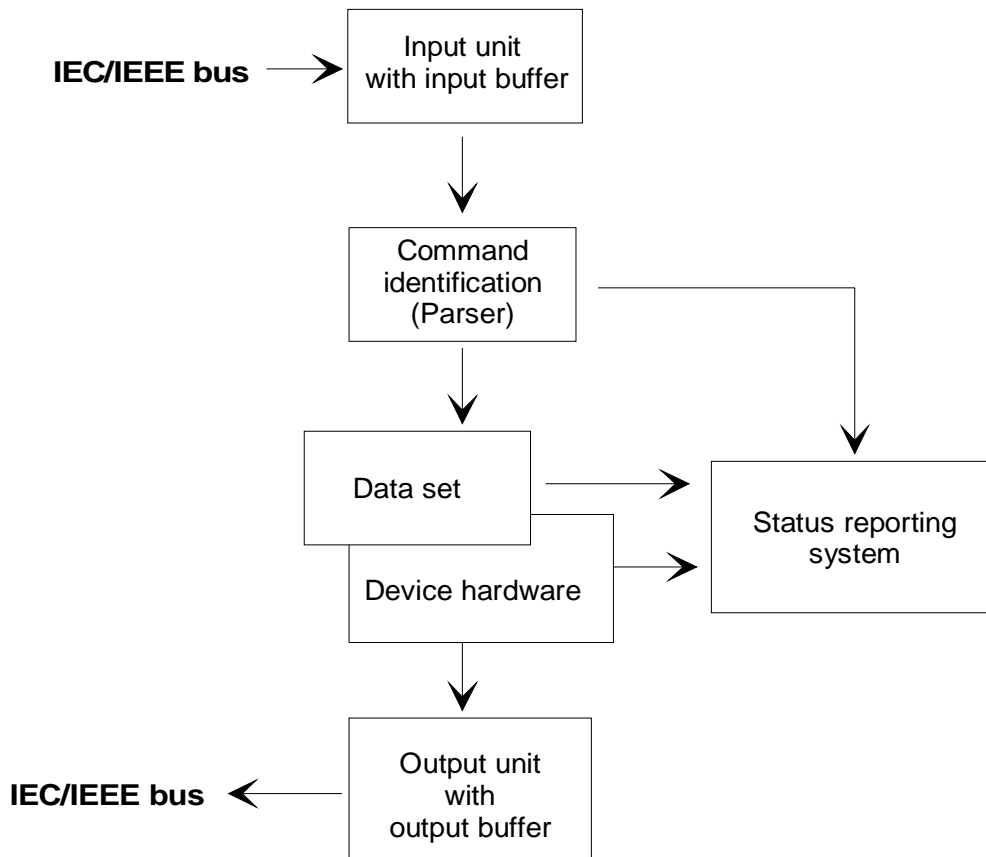

Fig. 3-4 Instrument model with remote control via IEC/IEEE-bus

#### 3.6.1 Input Unit

The input unit receives the commands in the form of characters from the IEC/IEEE bus and collects them in the input buffer. The input buffer has a capacity of 1024 characters. As soon as the input buffer is full or receives the interface message DCL, transfer on the IEC/IEEE bus is stopped and the received data are sent to the parser where the commands are checked for syntax and semantic errors and the hardware is set in the sequence in which the commands arrived. Data transfer on the IEC/IEEE bus is then continued. However, if the buffer is not yet full when a terminator is received, the input unit can receive the next command while the previous command is identified and executed. Reception of a DCL clears the input buffer.

### 3.6.2 Parser

The parser (to parse = grammatically analyze) analyzes the data received from the input unit proceeding in the order in which the data are received. A GET (Group Execute Trigger), for example, is only processed when the previously received commands are executed. A DCL command will be given priority. Each command identified as correct will immediately be executed and causes a hardware setting.

Syntax and semantic errors are recognized and passed on to the status reporting system. The remaining part of a command line after the syntax error will be further analyzed as far as possible and processed.

While the parser is setting the hardware, the input unit can collect new commands in the input buffer. This means that further commands can already be processed while settings are being made in the hardware ("overlapping execution").

### 3.6.3 Setting the Device Hardware

The term "device hardware" refers to that part of the UPL which performs the instrument function proper: signal generation, measurements, etc. This does not include the controller.

An IEC/IEEE-bus command line which may contain several setting commands is sent to the parser, which checks the IEC/IEEE-bus commands for syntax and semantic errors. If a command is identified as correct, a check is made with the aid of the current settings whether the command is permissible. Permissible commands are taken over into the UPL data set (corresponds to hardware settings) and the device hardware is set. If it turns out that the command is illegal because of the existing settings, as for example a generator level of 20 V on the unbalanced outputs, an "execution error" message is sent to the status reporting system and no new settings will be made in the device hardware for this command. Subsequent commands which prove to be permissible are executed as described in the following section.

This strictly hierarchical sequence ensures that at no time illegal device states will be set.

### 3.6.4 Why is a Specific Operating Sequence Sometimes Required?

- Each IEC/IEEE-bus command received by the UPL is immediately checked whether it is permissible. This check can only be carried out if the UPL knows which instrument or function the command is intended for, ie if the addressed instrument or command has been activated **before**.

#### Example1:

Selecting an input impedance of 600 Ohm is permissible for the balanced input, not for the unbalanced one.

If this check and the respective error messages were to be omitted, measurements would be carried out with incorrect instrument settings or would not be possible at all and the user would not even know about it.

#### Example2:

Setting: generator, unbalanced outputs.

Remote programming of 20 V generator level.

This is not possible, however, as the balanced output allows only 12 V to be set.

- Should the UPL accept this incorrect setting without signalling an error because the user might afterwards select unbalanced outputs which can handle 20 V.
- What will happen when this subsequent selection is not made?
- Should the incorrect voltage be output?
- Or, should an error message be output when the switchover is not performed?
- And **when** should this error be signalled?

These conflicts can be avoided by observing the required operating sequence!

- Since similar menu items of different instruments or functions are addressed with the same command in remote control, they can only be distinguished by a reference to the currently used instrument or function.

**Example:**

Command "INPut:SELEct CH1" may be used for all 3 analyzer units.

To provide the possibility for presetting also parameters of non-active functions, information on the instrument or function to be addressed would have to be added to each IEC/IEEE-bus command. Thus the internal address management of UPL commands would have to be carried out by the IEC/IEEE-bus programmer. This would make programming unnecessarily difficult and the number of commands would increase by many times. The UPL uses approx. 6000 menu items which would then have to be "called up" separately by the user.

- An important operational feature of the UPL is its capability to note the settings for the individual generator and analyzer functions and to restore all required parameters when one of these functions is selected.

This eliminates the need to reset each parameter when a new function is selected.

**Example:**

Settings: Generator, MOD DIST function with frequencies 400 Hz and 7 kHz.  
Switchover to DFD function

The frequency pair 11 and 12 kHz, which was set when the DFD function was used last, is automatically reset.

This function of the UPL is also available for operation via IEC/IEEE bus, ie even in the case of remote control a function switchover triggers an **automatic** reset of all pertaining parameters. This is a much quicker and more reliable than a reset of each parameter every time by the user via IEC/IEEE bus.

If settings for non-active instruments would be permissible as well, this automatic function could no longer be used, as in this case already set parameters would also be overwritten.

- As the same internal data sets are used for manual and remote control (combined manual and remote control should be possible), the same method of internal parameter processing can only be allowed for the two modes. Since automatic parameter restoration is indispensable for manual control, it must also be used in the case of remote operation.

To relieve the user from having to pay attention to such not so obvious conditions, the following applies for manual and remote control of the UPL:

*Any setting that is not permissible cannot become effective in the UPL*

This has sometimes the disadvantage that a certain sequence has to be observed even in the case of remote-control. However, this is more than compensated for by the fact that setting errors are immediately signalled.

**Note:**

*The command logging capability offered by the Universal Sequence Controller for UPL, option UPL-B10, minimized the risk of incorrect settings (see 3.15.3 Command Logging - Converting B10 into IEC/IEEE-Bus Commands)*

### 3.6.5 Status Reporting System

The status reporting system collects information on the device status and makes it available to the output unit on request. Structure and function are described in detail in section 3.7 **Status Reporting System**.

### 3.6.6 Output Unit

The output unit collects the information requested by the controller. It processes such information in line with the SCPI rules and makes it available in the 1024-character output buffer. If the requested information is longer it will be made available in blocks in a way that is not noticeable to the controller. If the UPL is addressed as a talker and the output buffer does not contain any data or expect data from the data set management, the output unit sends the error message "Query UNTERMINATED" to the status reporting system. No data will be sent on the IEC/IEEE bus and the controller waits for the set time limit. This procedure is prescribed by SCPI.

### 3.6.7 Triggering a Measurement/Sweep

A measurement or a sweep can be triggered in three different ways:

- With the SCPI-specific command `IEC OUT 20, "INIT"`
- With the Common Command `IEC OUT 20, "**TRG"`
- With the addressed command "**Group Execute Trigger**" `IEC LAD 20: IEC GET`

The three trigger modes take about the same execution time.

Universal Sequence Controller (UPL-B10)	RS-232 interface
See 3.16.4.4 <b>Differences from the IEC-bus Syntax - UPL-B10</b> The addressed GET command is illegal.	See 3.17.6 <b>Differences to Remote Control via IEC/IEEE Bus</b> The addressed GET command is illegal.

Another three commands are available for waiting for a triggered measurement result. They are described in section 3.6.8.3 Comparison of Synchronization Capabilities. The synchronization command "**\*WAI**" is used in the program examples below and in 3.15.15.1 Command Synchronization with \*WAI for demonstrating the three trigger modes for a single measurement.

### 3.6.8 Command Synchronization

There are two events in the UPL, which have to be waited for before the next command can be executed to make sure that subsequent commands meet clear conditions:

- End of a calibration
- End of a measurement (measurement result ready to be fetched)

Through programming, the controller can be forced to wait for the end of a calibration or measurement (see table 3-2 Comparison of synchronization capabilities). Commands "**\*OPC**", "**\*OPC?**" or "**\*WAI**" are used to ensure that a calibration or measurement is completed before a new command is sent (see section 3.6.8.3 Comparison of Synchronization Capabilities).

In the examples below synchronization by means of the \*WAI command is described.

### 3.6.8.1 Wait for End of Calibration

Wait for the calibration to be completed before sending the next setting command:

When analog analyzer instruments are called up with commands

```
IECOUT 20,"INSTrument2 A22;*WAI"
IECOUT 20,"INSTrument2 A110;*WAI"
```

with calibration switched on in the current setup ("CALibrate:ZERO:AUTO ON")  
or upon loading a setup with commands

```
IECOUT 20,"MMEMory:LOAD:STATe 0, 'filename';*WAI"
           (current setup)
IECOUT 20,"MMEMory:LOAD:STATe 2, 'filename';*WAI"
           (complete setup)
IECOUT 20,"*RST;*WAI"
           (default setup)
```

with calibration switched on in the setup to be loaded ("CALibrate:ZERO:AUTO ON")  
or after calling up a calibration with commands

```
IECOUT 20,"CALibrate:LDG:AUTO ONCE;*WAI" or "CALibrate LDG;*WAI"
IECOUT 20,"CALibrate:ZERO:AUTO ON;*WAI" or "CALibrate AUTO;*WAI"
IECOUT 20,"CALibrate:ZERO:AUTO ONCE;*WAI" or "CALibrate DCC;*WAI"
```

Without this forced synchronization, a subsequent generator or analyzer setting command would trigger a new calibration procedure.

### 3.6.8.2 Wait for End of Measurement/Sweep

**Note:**

*In the explanations below the term measurement result denotes either a single measurement result or a sequence of results obtained in a single sweep.*

A measurement or a sweep can be triggered by means of INIT , \*TRG or GET (see section 3.6.8.2 Wait for End of Measurement/Sweep).  
INIT will be used in the examples below.

With IEC/IEEE-bus commands assuming a settled measurement result, synchronization with \*WAI, \*OPC? or \*OPC must be effected by means of an SRQ. The use of the three synchronization methods is described in section 3.6.8.3 Comparison of Synchronization Capabilities.  
\*WAI will be used in the examples below.

The effect of the various combinations of measurement or sweep trigger with a synchronization command is described in the table below.

Table 3-1 Trigger command with/without synchronization

Trigger command with/without synchronization	Description
"INIT:CONT OFF; *WAI"	<p>A single measurement or sweep is triggered. Subsequent commands are processed after the measurement or sweep is completed. Generator and analyzer setting commands <b>do not</b> trigger a new measurement. A new measurement has to be triggered with IECOUT 20, "INIT; *WAI".</p> <p><b>This command is the simplest to use and should preferably be used for triggering a measurement.</b></p>
"INIT:CONT OFF" <b>without</b> *WAI	<p>When a generator or analyzer setting command is sent <b>during a single measurement</b>, ie before the measurement is completed, the measurement is restarted to avoid incorrect results (incorrect results could be obtained, for instance, when the generator voltage is varied during the measurement). Generator or analyzer setting commands sent <b>after the single measurement has been terminated</b> will <b>not</b> trigger a new measurement. A new measurement has to be triggered with IECOUT 20, "INIT" .</p>
"INIT:CONT ON; *WAI"	<p>Generator and analyzer setting commands will only be processed when the measurement is terminated. They will <b>not</b> trigger a new measurements. A new measurement has to be triggered with IECOUT 20, "INIT; *WAI" .</p>
"INIT:CONT ON" <b>without</b> *WAI	<p>Each generator or analyzer setting command restarts a measurement to avoid incorrect measurement results (incorrect results could be obtained, for instance, when the generator voltage is varied during the measurement).</p>

**Note:**

A synchronization of commands other than analyzer, generator, INIT, status loading or calibration commands is ineffective and should be avoided considering that synchronization commands are .

3.6.8.3 Comparison of Synchronization Capabilities

Table 3-2 Comparison of synchronization capabilities

Command	Action after hardware settling	Controller programming
*OPC?	Upon completion of the calibration or after a measurement result has been obtained, command "*OPC?" causes "1" to be entered in the output buffer. The "1" is irrelevant - the method is based on the fact that command IECIN 20,A\$ stops the program run until the buffer has a "1".  <b>This method is therefore not suitable to wait for a "1" in the program loop. This is possible with *OPC.</b>	IECOUT 20,"INST2 A22" IECOUT 20,"*OPC?" IECIN 20,A\$
*WAI	Upon completion of the calibration or after a measurement result has been obtained, the next command is executed.	IECOUT 20,"INST2 A22;*WAI"
*OPC	Upon completion of the calibration or after a measurement result has been obtained, the Operation Complete bit in the Event Status Register (ESR) is set which triggers an SRQ if bit 5 in the Status Enable Register is set.	- Set bit 0 in the ESE - Set bit 5 in the SRE - Wait for Service Request (SRQ)  <b>Advantage over "*OPC?" and "*WAI":</b> While waiting for SRQ with the Operation Complete bit in the Event Status Register set, the program may carry out other tasks.

Universal Sequence Controller (UPL-B10)	RS-232 interface
See 3.16.4.4 Differences from the IEC-bus Syntax - UPL-B10 *OPC cannot be used.	See 3.17.6 Differences to Remote Control via IEC/IEEE Bus *OPC cannot be used.

Detailed examples for command synchronization are given in section 3.15.15 Command Synchronization

3.7 Status Reporting System

The status reporting system (see Fig. 3-6, Overview of Status Register) stores all information on the current operating status of the UPL, eg AUTORANGE being performed, and on errors. Such information is stored in the status registers and in the error queue. The contents of the status registers and of the error queue can be queried via the IEC/IEEE bus.

The information is hierarchically structured. The topmost level is formed by the Status Byte Register (STB) defined by IEEE 488.2 and the associated mask register Service Request Enable (SRE). The STB receives its information from the Standard Event Status Register (ESR) also defined in IEEE 488.2 and the associated mask register Standard Event Status Enable (ESE) as well as from the SCPI-defined STATUS:OPERation and STATUS:QUESTionable registers and the UPL-specific register STATUS:XQUESTionable, which contain detailed information on the UPL.

The status reporting system also includes the IST flag (Individual SStatus) and the Parallel Poll Enable Register (PPE) assigned to it. The IST flag, just as SRQ, combines the complete device status in a single bit. The PPE for the IST flag has an analog function like the SRE has for the Service Request.



### 3.7.1 Structure of SCPI Status Register

The STATUS:OPERation Register and the STATUS:QUESTIONable Register (see section 3.7.3.4 STATUS:OPERation Register and) consists of five registers of 16 bits each with different functions (See Fig. 3-5). The individual bits are independent of each other, ie each hardware status is assigned a bit number which is the same for all five registers. Bit 5 of the STATUS OPERAtion Registers, for instance, is assigned in all five registers to the hardware status "wait for trigger". Bit 15 (the most significant bit) is set to zero in all registers. Thus the contents of the registers can be processed by the controller as a positive integer.

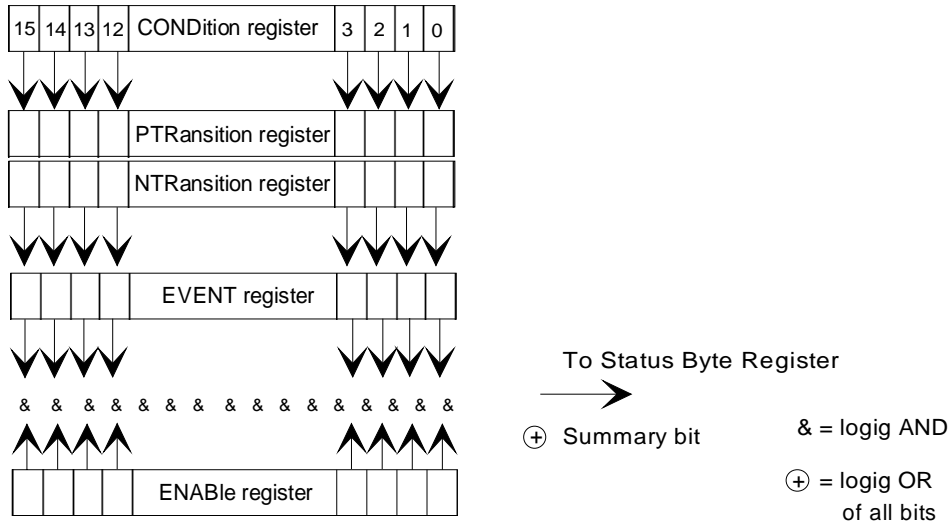

Fig 3-5 Status register model

#### CONDition register

The CONDition register is directly written to by the hardware or the summary bit of the next lower register. Its contents reflects the current device status. This register can only be read, but neither written to nor cleared. After an SRQ has been caused by an entry in one of the status registers, reading the CONDition register does **not** trigger another SRQ. Further SRQs are only possible when the EVENT register of the status register is read.

**Reading the register does not change its contents.**

#### PTRansition register

The Positive TRansition register acts as a transition filter. Upon transition of a bit of the CONDition register from 0 to 1, the associated PTR bit decides whether the EVENT bit will be set to 1  
 PTR bit = 1: the EVENT bit is set.  
 PTR bit = 0: the EVENT bit is not set.  
 This register can be written and read.

**Reading the register does not change its contents.**

**NTRansition register** The Negative TRansition register also acts as a transition filter. Upon transition of a bit of the CONDition register from 1 to 0, the associated NTR bit decides whether the EVENT bit is set to 1.  
NTR bit = 1: the EVENT bit is set.  
NTR bit = 0: the EVENT bit is not set.  
This register can be written and read.  
**Reading the register does not change its contents.**

With the aid of these two transition registers the user can define the status change of the CONDition register (none, 0 to 1, 1 to 0 or both) that is to be stored in the EVENT register.

**EVENT register** The EVENT register reports whether an event has occurred since its last reading, it is the memory of the CONDition register. It registers events that have been reported by the transition registers. The EVENT register is continuously updated by the instrument. It can only be read by the user.  
**Reading this register clears its contents.** After an SRQ has been caused by an entry in a status register, another SRQ is only possible when the EVENT register of the status register is read. Reading the CONDition register does **not** cause another SRQ.

This register is frequently referred to as the overall register.

**ENABLE register** The ENABLE register determines whether the EVENT bit affects the summary bit (see below). Each bit of the EVENT register is ANDed (symbol '&') with the associated ENABLE bit. The events of all logical operations of this register are ORed (symbol '+') and passed on to the summary bit.  
ENAB bit = 0: the associated EVENT bit does not affect the summary bit.  
ENAB bit = 1: if the associated EVENT is "1", the summary bit is also set to "1".  
This register can be written and read by the user.  
**Reading the register does not change its contents.**

**Summary bit** As stated above, the summary bit for each register is derived from the EVENT and the ENABLE registers. The result is entered into a bit of the CONDition register of the next higher register.  
The instrument automatically generates the summary bit for each register. An event, eg a non-locking PLL, may thus cause a service request through all hierarchical levels.

**Note:**

*The Service Request Enable Register SRE defined in IEEE 488.2 may be considered as the ENABLE register of the STB provided that the STB is configured in conformance with SCPI. Accordingly, the ESE may be considered as the ENABLE register of the ESR.*

3.7.2 Overview of Status Register

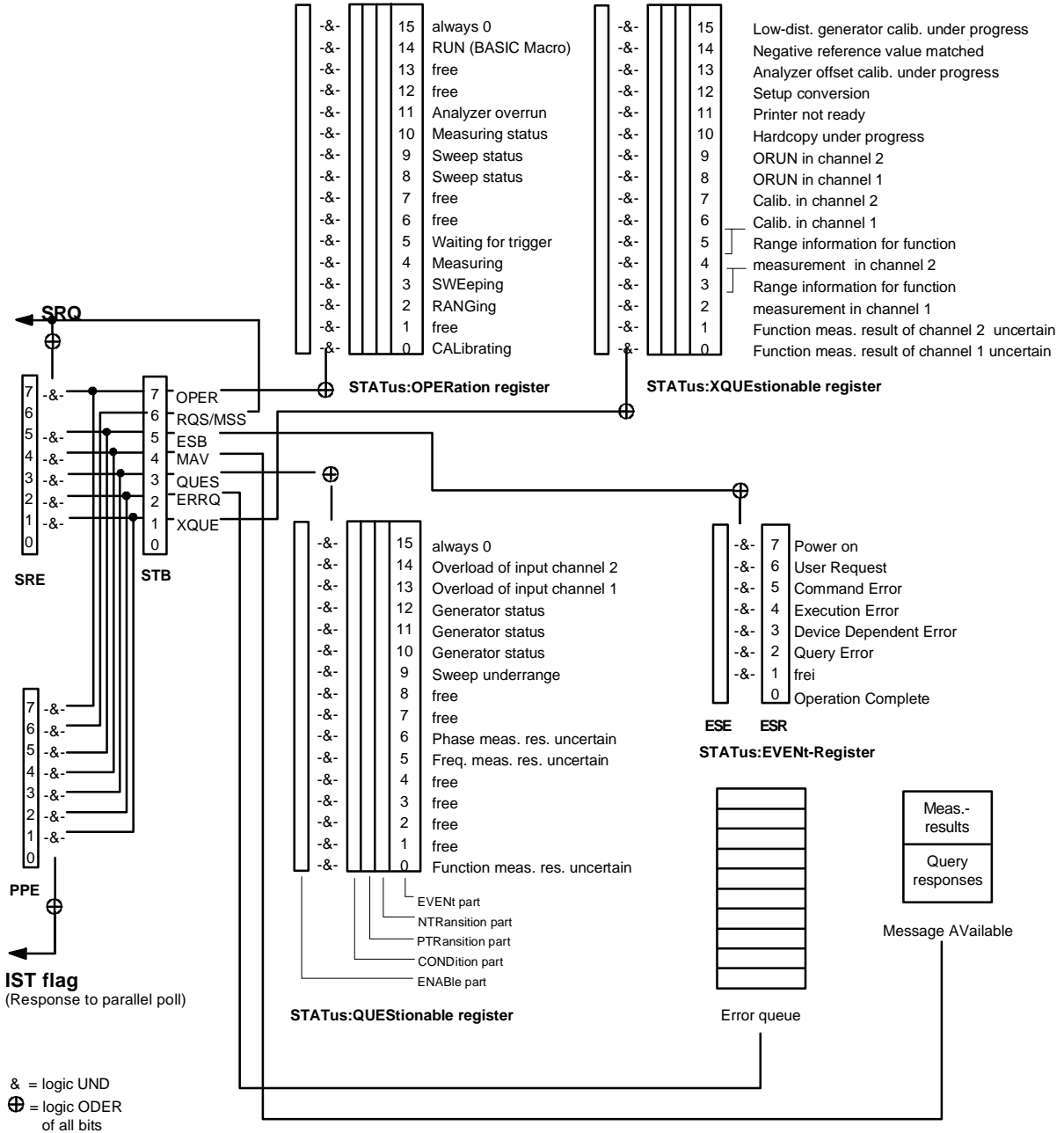

Fig. 3-6 Overview of Status Register

Universal Sequence Controller (UPL-B10)	RS-232 interface
See 3.16.4.4 Differences from the IEC-bus Syntax - UPL-B10 List of usable commands of the status reporting system.	See 3.17.6 Differences to Remote Control via IEC/IEEE Bus List of usable commands of the status reporting system.

### 3.7.3 Description of Status Registers

#### 3.7.3.1 Status Byte (STB) and Service Request Enable Register (SRE)

The STB is already defined in IEEE 488.2. It provides a rough overview of the UPL status, collecting information from the lower-level registers. It is comparable with the CONDITION register of a SCPI-defined register and is at the highest level of the SCPI hierarchy. Its special feature is that bit 6 acts as the summary bit of all other bits of the Status Byte Register.

The Status Byte Register is read out by the query \*STB? or a Serial Poll .

The SRE is associated with the STB. The function of the SRE corresponds to that of the ENABLE register of the SCPI registers. Each bit of the STB is assigned a bit in the SRE. Bit 6 of the SRE is ignored. If a bit is set in the SRE and the associated bit in the STB changes from 0 to 1, a Service Request (SRQ) will be generated on the IEC/IEEE bus, which triggers an interrupt in the controller configured for this purpose, and can be further processed by the controller.

The SRE can be set by the command \*SRE and read out by the query \*SRE?.

**Its contents are not set to zero during reading.**

If the EVENT part of a status register is read, the associated bit in the status byte register is deleted (eg STAT:OPER:EVEN? deletes the OPER bit (d7) in the OPERATION register).

Table 3-3 Definition of bits used in the Status Byte Register

Bit No.	Definition
0	<b>Free</b>
1	<b>XQUEstionable Status summary bit</b> This bit is set if in the XQUEstionable Status Register an EVENT bit is set and the associated ENABLE bit is set to 1. <b>The query command of the XQUEstionable Status Registers is "STATus:XQUEstionable:CONDition?" or "STATus:XQUEstionable[ :EVENT]?"</b>
2	<b>Error Queue EVENT]</b> ?" The Error Queue contains an entry to be read with command "SYSTem:ERRor?" followed by IECIN.
3	<b>QUESTionable Status summary bit</b> This bit is set if in the QUESTionable Status Register an EVENT bit is set and the associated ENABLE bit is set to 1. A set bit denotes a questionable device status which can be specified in greater detail by querying the QUESTionable Status Registers with "STATus:QUESTionable:CONDition?" or "STATus:QUESTionable[ :EVENT]?"
4	<b>MAV</b> A measurement result, response to a query (IEC/IEEE-bus command with '?') or Error Queue entry is available and can be read with an IECIN command.
5	<b>ESB bit</b> Summary bit of the Event Status Register. This bit is set if one of the bits in the Event Status Register is set and enabled in the Event Status Enable Register. Setting of this bit denotes a serious error which can be specified in greater detail by querying the Event Status Registers with "**ESR?".
6	<b>MSS bit</b> (master status summary bit) This bit is set if the UPL triggers a service request. This is the case if one of the other bits of this register is set together with its mask bit in the Service Request Enable Register SRE.
7	<b>OPERation Status Register summary bit</b> This bit is set if an EVENT bit is set in the OPERation Status Register and the associated ENABLE bit is set to 1. A set bit denotes that an action is just being performed by the UPL. Information on the type of the action can be obtained by querying the OPERation Status Register with "STATus:OPERation:CONDition?" or "STATus:OPERation[ :EVENT]?".
Universal Sequence Controller (UPL-B10)	
RS-232 interface	
See 3.16.4.4 Differences from the IEC-bus Syntax - UPL-B10 Cannot be used	
See 3.17.6 Differences to Remote Control via IEC/IEEE Bus Cannot be used	

**3.7.3.2 IST Flag and Parallel Poll Enable Register (PPE)**

Similar to the SRQ, the IST flag (Individual Status Flag) combines the complete status information in a single bit. It can be queried by a parallel poll (see section 3.7.4.3 Parallel Poll, and 3.15.16.1 SRQ Interrupt Routine with Serial Poll or with "\*IST?").

The Parallel Poll Enable Register (PPE) determines which bits of the STB affect the IST flag. The bits of the STB are ANDed with the corresponding bits of the PPE, bit 6 - in contrast to the SRE - being used too. The IST flag is obtained by ORing all results together. The PPE can be set by the command \*PRE and read by the query \*PRE?.

Universal Sequence Controller (UPL-B10)	RS-232 interface
See 3.16.4.4 Differences from the IEC-bus Syntax - UPL-B10 Cannot be used	See 3.17.6 Differences to Remote Control via IEC/IEEE Bus Cannot be used

**3.7.3.3 Definition of bits used in the Event Status Register**

The ESR is already defined in the IEEE 488.2 standard. It is comparable to the EVENT register of an SCPI register. The Event Status Register can be read out by the query \*ESR?. The ESE forms the associated ENABLE register. It can be set by the command \*ESE and read out by the query \*ESE?.

Table 3-4 Definition of bits used in the Event Status Register

Bit No.	Definition
0	<b>Operation Complete</b> Upon reception of the "*OPC" command this bit is set exactly when all previous commands have been executed.
1	<b>Free</b>
2	<b>Query Error</b> This bit is set if the controller wants to read data from the instrument but has not sent a data request command, or if the controller does not fetch the requested data but sends instead a new command to the instrument. A frequent cause is a faulty query which cannot be executed.
3	<b>Device-dependent Error</b> This bit is set if a device-dependent error occurs. An error message with a positive number denoting the error in greater detail in plain text (see 3.14 List of Error Messages) will be entered into the Error Queue.
4	<b>Execution Error</b> This bit is set if the syntax of the command received is correct but the command cannot be executed due to various marginal conditions. An error message with a number between -200 and -300 describing the error in greater detail (see 3.14 List of Error Messages) will be entered into the Error Queue.
5	<b>Command Error</b> This bit is set if an undefined command or a command with incorrect syntax is received. An error message with a number between -100 and -200 describing the error in greater detail (see 3.14 List of Error Messages) will be entered into the Error Queue.
6	<b>User Request</b> This bit is set upon pressing the [LOCAL] key, ie when the instrument is switched to manual control.
7	<b>Power On</b> This bit is set upon power on of the instrument.

### 3.7.3.4 STATus:OPERation Register

The CONDition part of this register contains information on the operations currently performed by the UPL and the EVENT part on the operations performed by the UPL since the last readout of the register.

The register can be read by the commands

"STATus:OPERation:CONDition?" or

"STATus:OPERation[:EVENT]?".

Table 3-5 Definition of bits used in the STATus:OPERation register

Bit No.	Definition																
0	<b>CALibrating</b> This bit is set as long as a calibration is performed by the UPL.																
1	<b>Free</b>																
2	<b>RANGing</b> This bit is set as long as the UPL performs a range change (eg. autorange).																
3	<b>SWEeping</b> This bit is set while the UPL is performing a sweep. Bits 8 and 9 inform on the current sweep state.																
4	<b>MEASuring</b> This bit is set while the UPL is performing a measurement. Bit 10 informs on the current measurement state.																
5	<b>WAIT for TRIGGER</b> This bit is set while the UPL waits for a trigger event.																
6 - 7	<b>Free</b>																
8 and 9	<b>Sweep Status</b> Bit 3, 9, 8 <table style="width: 100%; border: none;"> <tr> <td style="width: 50%;">0 0 0 = Sweep OFF</td> <td>No sweep performed</td> </tr> <tr> <td>0 0 1 = Sweep TERMINATED</td> <td>Single sweep completed</td> </tr> <tr> <td>0 1 0 = Sweep STOPPED</td> <td>Sweep has been stopped and may be continued</td> </tr> <tr> <td>0 1 1 = Sweep INVALID</td> <td>Sweep invalid as not yet started</td> </tr> <tr> <td>1 0 0 = Sweep MANU RUNNING</td> <td>Manual sweep running</td> </tr> <tr> <td>1 0 1 = Sweep SNGL RUNNING</td> <td>Single sweep running</td> </tr> <tr> <td>1 1 0 = Sweep CONT RUNNING</td> <td>Continuous sweep running</td> </tr> <tr> <td>1 1 1 = Sweep OFF</td> <td></td> </tr> </table>	0 0 0 = Sweep OFF	No sweep performed	0 0 1 = Sweep TERMINATED	Single sweep completed	0 1 0 = Sweep STOPPED	Sweep has been stopped and may be continued	0 1 1 = Sweep INVALID	Sweep invalid as not yet started	1 0 0 = Sweep MANU RUNNING	Manual sweep running	1 0 1 = Sweep SNGL RUNNING	Single sweep running	1 1 0 = Sweep CONT RUNNING	Continuous sweep running	1 1 1 = Sweep OFF	
0 0 0 = Sweep OFF	No sweep performed																
0 0 1 = Sweep TERMINATED	Single sweep completed																
0 1 0 = Sweep STOPPED	Sweep has been stopped and may be continued																
0 1 1 = Sweep INVALID	Sweep invalid as not yet started																
1 0 0 = Sweep MANU RUNNING	Manual sweep running																
1 0 1 = Sweep SNGL RUNNING	Single sweep running																
1 1 0 = Sweep CONT RUNNING	Continuous sweep running																
1 1 1 = Sweep OFF																	
10	<b>Measuring Status</b> Bit 4, 10 <table style="width: 100%; border: none;"> <tr> <td style="width: 50%;">0 0 = Measuring TERM</td> <td>Single measurement completed</td> </tr> <tr> <td>0 1 = Measuring STOP</td> <td>Measurement stopped</td> </tr> <tr> <td>1 0 = Measuring SNGL</td> <td>Single measurement running</td> </tr> <tr> <td>1 1 = Measuring CONT</td> <td></td> </tr> </table>	0 0 = Measuring TERM	Single measurement completed	0 1 = Measuring STOP	Measurement stopped	1 0 = Measuring SNGL	Single measurement running	1 1 = Measuring CONT									
0 0 = Measuring TERM	Single measurement completed																
0 1 = Measuring STOP	Measurement stopped																
1 0 = Measuring SNGL	Single measurement running																
1 1 = Measuring CONT																	
11	<b>Analyzer Overrun</b> The sampling rate applied to the external input is too high for the digital meter selected. Remedy: - Select a lower external sampling rate and set function again - Select a fast digital meter.																
12,13	<b>Free</b>																
14	<b>RUN (BASIC-Macro)</b> If a BASIC macro (see 2.16 Macro Operation) is started with the command SYST:PROG:EXEC 'filename.bas', this bit is set to 1. This bit is set to 0 when the program has been quit. This 1→0 transition can be queried via serial poll or initiate an SRQ, eg to fetch measurement data (for a detailed example see 3.15.18 Call BASIC-Macro																
15	<b>Free</b>																

### 3.7.3.5 STATus:QUEStionable Register

This register contains information on questionable device states. These may for instance occur if the UPL is operated out of specifications. The register can be read by the commands "STATus:QUEStionable:CONDition?" or "STATus:QUEStionable[:EVENT]?".

Table 3-6 Definition of bits used in the STATus:QUEStionable Register

Bit No.	Definition																
0	<p><b>Function</b></p> <p>This bit is set when the result of a function measurement is questionable.</p>																
1 - 4	<b>Free</b>																
5	<p><b>FREQuency</b></p> <p>This bit is set when the result of a frequency measurement is questionable.</p>																
6	<p><b>PHASe</b></p> <p>This bit is set when the result of a phase measurement is questionable.</p>																
7 - 8	<b>Free</b>																
9	<p><b>Sweep underrange</b></p> <p>During the sweep, valid but inaccurate measurement results were obtained because of underranging.</p>																
10 - 12	<p><b>Generator status</b> Bit 12, 11, 10</p> <table border="0"> <tr> <td>0 0 0 = Generator OFF</td> <td>Both generator channels are switched off</td> </tr> <tr> <td>0 0 1 = Generator OFF</td> <td></td> </tr> <tr> <td>0 1 0 = Generator RUNNING</td> <td>Generator outputs a signal</td> </tr> <tr> <td>0 1 1 = Generator BUSY</td> <td>Generator DSP computes a waveform</td> </tr> <tr> <td>1 0 0 = Generator HALTED</td> <td>No generator output signal due to incomplete or invalid setting</td> </tr> <tr> <td>1 0 1 = Generator OVERRUN</td> <td>The sampling rate applied to the external input is too high for the digital generator selected Remedy: - Select lower sampling rate, call up function again. - Select faster digital generator</td> </tr> <tr> <td>1 1 0 = Generator OFF</td> <td></td> </tr> <tr> <td>1 1 1 = Generator OFF</td> <td></td> </tr> </table>	0 0 0 = Generator OFF	Both generator channels are switched off	0 0 1 = Generator OFF		0 1 0 = Generator RUNNING	Generator outputs a signal	0 1 1 = Generator BUSY	Generator DSP computes a waveform	1 0 0 = Generator HALTED	No generator output signal due to incomplete or invalid setting	1 0 1 = Generator OVERRUN	The sampling rate applied to the external input is too high for the digital generator selected Remedy: - Select lower sampling rate, call up function again. - Select faster digital generator	1 1 0 = Generator OFF		1 1 1 = Generator OFF	
0 0 0 = Generator OFF	Both generator channels are switched off																
0 0 1 = Generator OFF																	
0 1 0 = Generator RUNNING	Generator outputs a signal																
0 1 1 = Generator BUSY	Generator DSP computes a waveform																
1 0 0 = Generator HALTED	No generator output signal due to incomplete or invalid setting																
1 0 1 = Generator OVERRUN	The sampling rate applied to the external input is too high for the digital generator selected Remedy: - Select lower sampling rate, call up function again. - Select faster digital generator																
1 1 0 = Generator OFF																	
1 1 1 = Generator OFF																	
13 -14	<p><b>Analyzer Status</b> Bit 14, 13</p> <table border="0"> <tr> <td>0 0 =</td> <td>Normal working order (no overload at any channel)</td> </tr> <tr> <td>0 1 = ANL 1: OVLD</td> <td>Overload at input channel 1</td> </tr> <tr> <td>1 0 = ANL 2: OVLD</td> <td>Overload at input channel 2</td> </tr> <tr> <td>1 1 = ANL 1: OVLD 2: OVLD</td> <td>Overload at both input channels</td> </tr> </table> <p>With input impedance of 300Ω or 600Ω one or both input channels are overloaded! To protect the analyzer input against damages the input impedance temporarily is switched to 200 kΩ and the generator output is turned off. Measurement will be continued.</p> <p><b>Ways to recover from overload:</b> - remove overload (input voltage at 300Ω or 600Ω must not exceed 25 V) or - set input impedance to 200kΩ (INP:IMP R200K). Reactivate generator output by sending command "OUTPut ON". C.f. <b>2.13 Fast Switch-off of Outputs</b>. The overload protection of the analyzer inputs is valid for analog board versions ≥ 4.00 and software version ≥ 1.0.</p>	0 0 =	Normal working order (no overload at any channel)	0 1 = ANL 1: OVLD	Overload at input channel 1	1 0 = ANL 2: OVLD	Overload at input channel 2	1 1 = ANL 1: OVLD 2: OVLD	Overload at both input channels								
0 0 =	Normal working order (no overload at any channel)																
0 1 = ANL 1: OVLD	Overload at input channel 1																
1 0 = ANL 2: OVLD	Overload at input channel 2																
1 1 = ANL 1: OVLD 2: OVLD	Overload at both input channels																
15	<b>Free</b>																

## 3.7.3.6 STATUS XQUESTIONABLE REGISTER

This register contains additional information for the Status Operation Register and information on rarely occurring states. It can be read by the queries "STATUS:XQUESTIONABLE:CONDITION?" or "STATUS:XQUESTIONABLE[:EVENT]?".

Table 3-7 Definition of bits used in the STATUS:XQUESTIONABLE Register

Bit No.	Definition																		
0	<p>Bit set: Information of MEASuring bit (d4) and Measuring Status bit (d10) of Status Operation Register refers to <b>channel 1</b>.</p> <table border="0"> <tr> <td style="padding-right: 20px;">┌───┐</td> <td>MEASuring bit (d4)</td> <td></td> </tr> <tr> <td style="padding-right: 20px;">└───┘</td> <td>Measuring status bit (d10)</td> <td></td> </tr> <tr> <td>0 0 =</td> <td>Measuring TERM</td> <td>Single measurement terminated on</td> </tr> <tr> <td>0 1 =</td> <td>Measuring STOP</td> <td>Measurement stopped on</td> </tr> <tr> <td>1 0 =</td> <td>Measuring SNGL</td> <td>Single measurement in progress on</td> </tr> <tr> <td>1 1 =</td> <td>Measuring CONT</td> <td>Continuous measurement in progress on</td> </tr> </table>	┌───┐	MEASuring bit (d4)		└───┘	Measuring status bit (d10)		0 0 =	Measuring TERM	Single measurement terminated on	0 1 =	Measuring STOP	Measurement stopped on	1 0 =	Measuring SNGL	Single measurement in progress on	1 1 =	Measuring CONT	Continuous measurement in progress on
┌───┐	MEASuring bit (d4)																		
└───┘	Measuring status bit (d10)																		
0 0 =	Measuring TERM	Single measurement terminated on																	
0 1 =	Measuring STOP	Measurement stopped on																	
1 0 =	Measuring SNGL	Single measurement in progress on																	
1 1 =	Measuring CONT	Continuous measurement in progress on																	
1	<p>Bit set: Information of MEASuring bit (d4) and Measuring Status bit (d10) of Status Operation Register refers to <b>channel 2</b>.</p> <p>Analogous to bit No. 0.</p>																		
2 - 3	<p>Additional range information for <b>channel 1</b></p> <table border="0"> <tr> <td>d3 d2</td> <td></td> </tr> <tr> <td>0 0 =</td> <td>Measurement result valid</td> </tr> <tr> <td>0 1 =</td> <td>Ranging in channel 1.</td> </tr> <tr> <td></td> <td>Bit d2 (RANGing) of STATUS OPERAtion Register set simultaneously.</td> </tr> <tr> <td>1 0 =</td> <td>Underrange (measurement result inaccurate) in channel 1</td> </tr> <tr> <td>1 1 =</td> <td>Overrange (measurement result invalid) in channel 1</td> </tr> <tr> <td></td> <td>Function bit d0 (function measurement result uncertain) of the Status Questionable Register set simultaneously with underrange and overrange bits.</td> </tr> </table>	d3 d2		0 0 =	Measurement result valid	0 1 =	Ranging in channel 1.		Bit d2 (RANGing) of STATUS OPERAtion Register set simultaneously.	1 0 =	Underrange (measurement result inaccurate) in channel 1	1 1 =	Overrange (measurement result invalid) in channel 1		Function bit d0 (function measurement result uncertain) of the Status Questionable Register set simultaneously with underrange and overrange bits.				
d3 d2																			
0 0 =	Measurement result valid																		
0 1 =	Ranging in channel 1.																		
	Bit d2 (RANGing) of STATUS OPERAtion Register set simultaneously.																		
1 0 =	Underrange (measurement result inaccurate) in channel 1																		
1 1 =	Overrange (measurement result invalid) in channel 1																		
	Function bit d0 (function measurement result uncertain) of the Status Questionable Register set simultaneously with underrange and overrange bits.																		
4 - 5	<p>Additional range information for <b>channel 2</b></p> <table border="0"> <tr> <td>d3 d2</td> <td></td> </tr> <tr> <td>0 0 =</td> <td>Measurement result valid</td> </tr> <tr> <td>0 1 =</td> <td>Ranging in channel 2.</td> </tr> <tr> <td></td> <td>Bit d2 (RANGing) of STATUS OPERAtion Register set simultaneously.</td> </tr> <tr> <td>1 0 =</td> <td>Underrange (measurement result inaccurate) in channel 2</td> </tr> <tr> <td>1 1 =</td> <td>Overrange (measurement result invalid) in channel 2</td> </tr> <tr> <td></td> <td>Function bit d0 (function measurement result uncertain) of the Status Questionable Register set together with the underrange and overrange bits.</td> </tr> </table>	d3 d2		0 0 =	Measurement result valid	0 1 =	Ranging in channel 2.		Bit d2 (RANGing) of STATUS OPERAtion Register set simultaneously.	1 0 =	Underrange (measurement result inaccurate) in channel 2	1 1 =	Overrange (measurement result invalid) in channel 2		Function bit d0 (function measurement result uncertain) of the Status Questionable Register set together with the underrange and overrange bits.				
d3 d2																			
0 0 =	Measurement result valid																		
0 1 =	Ranging in channel 2.																		
	Bit d2 (RANGing) of STATUS OPERAtion Register set simultaneously.																		
1 0 =	Underrange (measurement result inaccurate) in channel 2																		
1 1 =	Overrange (measurement result invalid) in channel 2																		
	Function bit d0 (function measurement result uncertain) of the Status Questionable Register set together with the underrange and overrange bits.																		
6	<p>Bit set: The calibration denoted in bit 13 or 15 is in progress in <b>channel 1</b>. No measurements are performed during this period.</p>																		
7	<p>Bit set: The calibration denoted in bit 13 or 15 is in progress in <b>channel 2</b>. No measurements are performed during this period.</p>																		
8	<p>Bit set: The sampling rate at the external input of <b>channel 1</b> is too high for the digital instrument. Remedy: Set lower rate and recall measurement function.</p>																		
9	<p>Bit set: Ditto for <b>channel 2</b></p>																		
10	<p>Bit set: Read-out of screen content to a printer or a file. Operation of UPL is disabled for a few seconds.</p>																		
11	<p>Bit set: Printer not ready.</p>																		
12	<p>Bit set: A previous SETUP is converted to the latest status.</p>																		
13	<p>Bit set: Calibration of analyzer offset in progress. No measurement results are output during this period.</p>																		
14	<p>Bit set: A negative reference value is limited to <math>+10^{-10}</math> for the dBr calculation.</p>																		
15	<p>Bit set: Calibration of low-distortion generator in progress. No measurement results are output during this period.</p>																		



### 3.7.4 Use of Status Reporting System

For an efficient use of the status reporting system, the information contained therein has to be transferred to the controller and further processed. There are various methods which are described in the following. Detailed program examples are given in **3.15 Examples of IEC/IEEE-Bus Programming**.

#### 3.7.4.1 Service Request, Use of Hierarchical Structure

Under certain conditions, the UPL may send a service request (SRQ) to the controller. This service request usually causes an interrupt at the controller to which the controller program can respond by a suitable action. As shown in Fig. 3-6 (Section 3.7.2 Overview of Status Register), a SRQ will always be triggered if one or several of the bits 3, 5 or 7 have been set in the Status Byte Register and enabled in the SRE. Each of these bits combines the information from a further status register. By setting the ENABLE registers of the status registers accordingly, any bit in any status register will be able to trigger a SRQ. To utilize the possibilities of the service request, all bits in the enable registers SRE and ESE should be set to "1".

Examples:

(see also Fig 3-6 , Section 3.7.2 Overview of Status Register ):

Use command "*\*OPC*" for generating an SRQ. While waiting for the SRQ, the program may perform other tasks.

- Setting bit 0 (Operation Complete) in the ESE
- Setting bit 5 (ESB) in the SRE

Upon completion of the settings, the UPL generates an SRQ.

Indicating the end of a sweep by an SRQ via bit 3 in the STATus OPERation Register. While waiting for the SRQ the program may perform other tasks.

- Setting bit 7 (summary bit of STATus:OPERation Register) in the SRE
- Setting bit 3 (Sweep Terminated) in the STATus:OPERation:ENABLE Register.
- Setting bit 3 in the STATus:OPERation:NTRansition to ensure that the transition of sweeping bit 3 from 1 to 0 (Sweep-Terminated) is also stored in the EVENT register. Calling up the *\*CLS* command causes all bits of the NTRansition and PTRansition to be set to 1 so that any bit change is recorded. Enabling the desired enable bit, in this case bit 3, will normally be sufficient.

After having completed the sweep, the UPL generates an SRQ.

The SRQ is thus the only way for the UPL to become active of its own. A controller program should set the UPL so that a service request will be generated in case of malfunctions. The program should suitably respond to the service request. A detailed example of a service request routine is given in section 3.15.15 Command Synchronization.

Universal Sequence Controller (UPL-B10)	RS-232 interface
See <b>3.16.4.4 Differences from the IEC-bus Syntax - UPL-B10</b> Cannot be used	See <b>3.17.6 Differences to Remote Control via IEC/IEEE Bus</b> Cannot be used

**3.7.4.2 Serial Poll**

Serial Poll is mainly used for obtaining a quick overview of the status of several devices connected to the IEC/IEEE bus

In the case of a Serial Poll, the status byte of a device can be queried with

```
IECOUT 20, "*STB?"
IEC IN 20,A%
```

However, querying the status byte is normally implemented by interface messages (see annex A, Interface Messages) which means that a single byte is set to the hardware.

The R&S BASIC command for the execution of a Serial Poll is

```
IEC SPL 20,A%
```

It is much quicker than the Common Command "\*STB?".

The serial poll method has already been defined in the IEEE 488.1 standard and used to be the only standard method for querying the status byte of several devices. This method also works with instruments which neither conform to SCPI nor to IEEE 488.2.

Universal Sequence Controller (UPL-B10)	RS-232 interface
See 3.16.4.4 Differences from the IEC-bus Syntax - UPL-B10 Cannot be used	See 3.17.6 Differences to Remote Control via IEC/IEEE Bus Cannot be used

**3.7.4.3 Parallel Poll**

In the parallel poll mode up to eight devices are simultaneously requested by a command from the controller to transmit 1 bit of information on the assigned data line, ie to pull the assigned data line to logic 0 or 1. Similar to the SRE register which defines the conditions under which an SRQ will be generated, there is a Parallel Poll Enable Register (PPE), which is also ANDed bit by bit with the STB – taking into account bit 6. The result is ORed and is then returned (may be inverted) as a reply to a parallel poll of the controller. The result can also be read out without parallel poll by the query \*IST.

The UPL must first be set for the parallel poll using the R&S BASIC command IEC PCON.

Example:

```
IECPCON 20,1,6: UPL identifies itself by a 1 on line 6.
```

This command assigns a data line to the device on which it sends an SRQ. The parallel poll itself is made by IEC PPL Pp%.

The parallel poll mode is mainly used to find out quickly which of the devices connected to the IEC/IEEE bus has caused an SRQ. For this purpose SRE and PPE must be set to the same value. A detailed example of parallel poll is given in section 3.15.16.1.2 Serial Poll SRQ Routine.

Universal Sequence Controller (UPL-B10)	RS-232 interface
See 3.16.4.4 Differences from the IEC-bus Syntax - UPL-B10 Cannot be used	See 3.17.6 Differences to Remote Control via IEC/IEEE Bus Cannot be used

#### 3.7.4.4 Queries

Each individual register of a status register can be read out by queries. The individual queries are given in the detailed description of the registers in Section 3.7.3 Description of Status Registers. The queries always return a number representing the bit pattern of the queried register. This number is evaluated by the controller program.

Queries are mainly used after a SRQ to obtain detailed information on the cause for the SRQ.

#### 3.7.4.5 Error Queue Query

- Each error condition in the instrument causes an entry in the error queue. The entries in the error queue are detailed error messages in plain text which can be read out via IEC/IEEE bus by the query `SYSTem:ERRor?`. Each query `SYSTem:ERRor?` returns an entry from the error queue. If there are no more error messages in the error queue, **0 = "No error"** is returned by the instrument
- The error queue should be queried in the controller program after each SRQ since the queue entries provide a more precise description of the error cause than the status registers. In particular in the test phase of a controller program the error queue should be queried at regular intervals since it also registers faulty commands from the controller to the UPL.

**Note:**

*In addition to an entry in the Error Queue, each error causes a plain-text message to be output on the UPL display so that the IEC/IEEE-bus control program can be checked in the REMOTE control mode without reading out the Error Queue.*

### 3.7.5 Resetting the Status Reporting Systems

Table 3-8 contains the various commands and events causing a reset of the status reporting system. None of the commands, with the exception of \*RST affects the functional device setting. In particular DCL does not clear the device settings.

Table 3-8 Resetting of device functions

Event	Effect			
	DCL, SDC (Device Clear, Selected Device Clear)	*RST or SYSTEM:PRESet	STATUS:PRESet	*CLS
Clears STB, ESR	—	—	—	yes
Clears SRE, ESE	—	—	—	—
Clears PPE	—	—	—	—
Clears EVENT registers	—	—	—	yes
Clears ENABLE registers of OPERATION, QUESTIONable and XQUESTIONable Register, fills ENABLE registers of all other registers with "1".	—	—	yes	—
Fills PTRansition registers with "1", clears NTRansition registers	—	—	yes	—
Clears Error Queue	—	—	—	yes
Clears output buffer	yes	1)	1)	1)
Clears command processing and input buffer	yes	—	—	—

1) Any command that is the first one in a command line clears the output buffer.

### 3.8 Notation of Command Table

All commands implemented in the UPL according to the command system are tabulated and described in detail in section 3.10 **IEC-bus Commands**. The notation is in line with the SCPI standard provided the committee has defined a command for the required function.

#### Command table in section 3.10 IEC-bus Commands

Command:	In this column the complete command without parameters is listed.
Parameter:	Here the required parameters and their range of values are stated. If the command is only available in the form of a query, 'Query only' is marked in this column.
Basic unit:	Basic unit of physical parameter.
Meaning:	Brief description of command.
Section:	Reference to the detailed function description in the case of manual operation, mainly section 2 of the UPL manual.

**Upper/lower case** Upper/lowercase characters are used to differentiate between the long form and the short form of the keywords of a command. The UPL itself does not distinguish between uppercase and lowercase letters.

**Special character |** For some commands there is a choice of keywords having the same effect. These keywords are stated in the same line and separated by a vertical bar. Only one of these keywords need to be stated in the header of the command. The effect of the command is independent of the keyword selected.

Example: "SOURce:FREQuency:CW|:FIXed"  
(setting generator to a constant frequency of 1 kHz)

The two commands below have an identical effect  
"SOURce:FREQuency:CW 1E3"≡ "SOURce:FREQuency:FIXed 1E3"

A vertical bar in the notation of the parameters is used to separate alternative options and is to be seen as "or". The effect of the command differs according to the parameter stated.

Example: Selection of parameters for the command  
"SENSe:VOLTage:UNIT V|DBV|DBU"  
(measurement result may be displayed in Volt, dBV or dBu)

**Special characters [ ]** Keywords in square brackets may be omitted in compound headers (see section 3.5.3 Structure of a Command Line). For reasons of compatibility with the SCPI standard, the instrument must be able to accept the full length of the command. Parameters in square brackets may also be optionally inserted in the command or omitted.

Example: "SENSe[1][:VOLTage|POWer]:REFerence:MODE . . ."  
has the same effect as  
"SENSe:REFerence:MODE . . ."  
(selecting the method for generating a level reference value)

**Parameters in square brackets**

may also be optionally inserted in the command or omitted.

Example: TRACe[1] stands for TRACe and TRACe1

TRACe[1|2] denotes that either TRACe1 or TRACe2 can be selected, causing **different settings**.  
 DISPlay:TRACe[1|2]:MARKer MODE ...  
 (markers for FFT spectrum display may be different for TRACe1 and TRACe2)

TRACe[] denotes that the command can be used for TRACe1 and TRACe2, causing the **same settings** in both cases.  
 DISPlay:TRACe[ ]:CURSor[1]:MODE ...  
 (selected cursor function apply to both traces!)

**Special characters { }**

Parameters in curly brackets may be included in the command as often as required.

Example: SENSE[1]:LIST:FREQuency <n>{ , <n> }  
 (frequencies of an RMS-selective sweep)

### 3.9 Common Commands

The common commands are based on the IEEE 488.2 (IEC 625.2) standard. A specific command has the same effect in different instruments. The headers of these commands consist of an asterisk "\*" followed by three letters. Many common commands refer to the status reporting system described in detail in section 3.15 **Examples of IEC/IEEE-Bus Programming**.

Table 3-9 Common Commands

Command	Brief description	Parameter / Notes	Universal Sequence Controller UPL-B10	RS-232 interface
*CLS	Resets status byte	no query	Not usable	Not usable
*ESE	Sets Event Status Enable Register	0 to 255	Not usable	Not usable
*ESR?	Readout of content of Event Status Register	query only	Usable	Usable
*IDN?	Identification query	ROHDE&SCHWARZ, UPL, 0, 2.xx	Usable	Usable
*IST?	Query for content of IST flag	query only	Not usable	Not usable
*OPC	Synchronization command		Usable	Usable
*PCB	Address for passing back the IEC/IEEE-bus control	0 to 30, no query	Not usable	Not usable
*PRE	Sets Parallel Poll Enable Register	0 to 255	Not usable	Not usable
*RST	Resets the device to a defined default state. The parameter link (see 2.15.8 <b>Transfer of Parameters</b> (Parameter Link Function)) is disabled to maintain the default setting described in Appendix A <b>UPL Default Setup</b>	no query	Usable	Usable
*SRE	Sets Service Request Enable Register	0 to 255	Not usable	Not usable
*STB?	Query for content of Status Byte	query only	Not usable	Not usable
*TRG	Triggers measurement	no query	Usable	Usable
*TST?	UPL selftest	query only	Usable	Usable
*WAI	Synchronization command		Usable	Usable

#### \*CLS

**CLEAR STATUS** sets the status byte (STB), the Standard Event Register (ESR) and the EVENT part of the QUESTIONable, OPERATION and of the XQUESTIONable Register to zero. The command has no effect on the mask and transition parts of the register. The output buffer is cleared.

#### \*ESE 0 to 255

**EVENT STATUS ENABLE** sets the Event Status Enable Register to the defined value. The query \*ESE? returns the content of the Event Status Enable Registers in decimal form.

#### \*ESR?

**EVENT STATUS ENABLE** returns the contents of the Event Status Enable Register in decimal form (0 to 255) and clears the register.

**\*IDN?**

**IDENTIFICATION QUERY** for identification of the instrument.

The response is for example: "Rohde&Schwarz, UPL, 0, 2.xx"

UPL = instrument designation: 0 = serial number, 2.xx = firmware version

**\*IST?**

**INDIVIDUAL STATUS QUERY** returns the contents of the IST flag in decimal form (0 | 1).

The IST flag is the status bit sent during a Parallel Poll (see section 3.7.3.2 IST Flag and Parallel Poll Enable Register (PPE)).

**\*OPC**

**OPERATION COMPLETE** sets bit 0 in the Event Status Register if all preceding commands have been executed. This bit may be used to assert a Service Request (see section 3.6.8.3 Comparison of Synchronization Capabilities, 3.7.3.3 Event Status Reg. (ESR), Event Status Enable Reg. (ESE), and section 3.15.15.3 Command Synchronization with \*OPC and SRQ

**\*OPC?**

**OPERATION COMPLETE QUERY** places an ASCII character "1" in the output buffer as soon as all preceding commands have been executed (see 3.6.8.3 Comparison of Synchronization Capabilities and section 3.15.15.3 Command Synchronization with \*OPC and SRQ.

**\*PCB 0 to 30**

**PASS CONTROL BACK** notifies the address of the controller to which the IEC/IEEE-bus control is to returned.

**\*PRE 0 to 255**

**PARALLEL POLL REGISTER ENABLE** sets the Parallel Poll Enable Register to the defined value. The query \*PRE? returns the contents of the Parallel Poll Enable Registers in decimal form

**\*RST**

**RESET** sets the UPL to a defined default state. The parameter-Link (see 2.15.8 Transfer of Parameters (Parameter Link Function)) is switched off to ensure that the default state as described in Annex A UPL Default Setup is maintained after a change of instrument or function.

**\*SRE 0...255**

**SERVICE REQUEST ENABLE** sets the Service Request Enable Register to the defined value. Bit 6 (MSS mask bit) remains 0. This command determines the conditions under which a Service Request will be asserted. The query \*SRE? outputs the contents of the Service Request Enable Registers in decimal form.

Bit 6 is always 0.

**\*STB?**

**READ STATUS BYTE QUERY** outputs the contents of the status byte in decimal form.

**Its contents are not set to zero during reading.**

If the EVENT part of a status register is read, the associated bit in the status byte register is deleted (eg STAT:OPER:EVENT? deletes the OPER bit (d7) in the OPERAtion register).

**\*TRG**

**TRIGGER** starts all actions waiting for a trigger event.

See sections 3.6.7 Triggering a Measurement/Sweep; 3.6.8.2 Wait for End of Measurement/Sweep and section 3.15.8.1 Readout of Triggered Measurements.

**\*TST?**

**SELF TEST QUERY** causes a brief selftest of the UPL and outputs an error code in decimal form ('0' for ok., '1' for error)

**\*WAI**

**WAIT-to-CONTINUE** allows processing of commands only after all preceding commands have been executed, all signals settled and current measurements are terminated (see sections 3.6.8.2 Wait for End of Measurement/Sweep, 3.6.8.3 Comparison of Synchronization Capabilities, and section 3.15.15.1 Command Synchronization with \*WAI.



**IEC/IEEE-Bus Commands**

Selection of Generator · Configuration of Analog Generators · Configuration of Digital Generators  
• Generator Sweeps · Generator Functions

**IEC/IEEE-Bus Commands for Analyzers**

Selection of Analyzer · Configuration of Analog Analyzers · Configuration of Digital Analyzers  
• Starting the Analyzer, Ext. Sweep · Analyzer Functions

**Selection of Analyzer Filter****Units for IEC/IEEE Measurement Results****Loading and Storing**

Loading and Storing Instrument Setups · Loading and Storing Traces and Lists

**Commands for Graphical Representation of Results****Commands for Printing/Plotting of Screen and Storing in Files****Setting and Display of Auxiliary Parameters**

IEC/IEEE-Bus Address · Keyboard Settings · Tastatureinstellungen · Setting and Switching  
Off the Displays · Version Display · Calibration · Transfer of Settings · Parameters of COM2 Interface  
• Loading Speed for Setups and Analyzer Measurement Functions

**Commands for Data Output****Commands for Input/Output of Block Data****Commands for Status and Error Queries****Commands for Synchronization****Settings without Corresponding IEC/IEEE-Bus Command****Alphabetical List of IEC/IEEE-Bus Commands**





### 3.10 IEC/IEEE-Bus Commands

#### 3.10.1 Generators

##### 3.10.1.1 Selection of Generator

Command	Parameter	Basic unit	Meaning	Section
<b>INSTRument[1]:SElect</b> equivalent to <b>INSTRument[1]:NSElect</b>	<b>A25</b>  <b>D48</b> alias  1 3		<ul style="list-style-type: none"> <li>→ Two-channel analog generator, frequency range: 2 Hz to 21.75 kHz with universal generator 10 Hz to 110 kHz low-distortion generator (UPL-B1 option)</li> <li>→ Two-channel digital generator, frequency range: 2 Hz to 21.93 kHz with option UPL-B2 (digital audio I/O) 2 Hz to 43.86 kHz with option UPL-B29 (digital audio 96 kHz)</li> <li>→ Analog generator</li> <li>→ Digital generator</li> </ul>	<b>2.5.1</b> <b>GEN panel</b> <b>INSTRUMENT</b> → ANALOG → DIGITAL

##### 3.10.1.2 Configuration of Analog Generators

Command	Parameter	Basic unit	Meaning	Section
<b>OUTPut:SElect</b>	<b>OFF</b> <b>CH1</b> <b>CH2</b> <b>CH2Is1</b>		<ul style="list-style-type: none"> <li>→ Generator channels switched off</li> <li>→ Only generator channel 1 active</li> <li>→ Only generator channel 2 active</li> <li>→ Both generator channels active</li> </ul>	<b>2.5.2</b> <b>GEN panel</b> <b>Channel(s)</b> → OFF → 1 → 2 → 2 = 1

Command	Parameter	Basic unit	Meaning	Section
<b>OUTPUT:TYPE</b>	<b>BALanced</b> <b>UNBALanced</b>		→ Balanced output (XLR connector) → Unbalanced output (BNC connector)	<b>2.5.2 GEN panel</b> Output → BAL → UNBAL
<b>OUTPUT:IMPedance</b>	<b>R10</b> <b>R200</b> <b>R150</b> (Query reply. = R200) <b>R600</b>		Only for OUTPUT:TYPE Bal → Output impedance 10 Ω → Output impedance 200 Ω → Output impedance 150 Ω, if the standard generator source impedance was changed from 200 Ω to 150 Ω using Modification Analog Generator UPL-U3 (Order No. 1078.4900.02) → Output impedance 600 Ω	<b>2.5.2 GEN panel</b> Impedance → 10 Ω → 200 Ω (→ 150 Ω) → 600 Ω
<b>SOURCE:VOLTage:RANGE:AUTO</b>	<b>ON</b>  <b>OFF</b>		Range selection for setting the generator output voltage. → D/A converters operating at full range. The output voltage is set using the output amplifier. Optimum noise and THD values. Any maximum voltage can be entered with command SOUR:VOLT:LIM <nu>, higher voltages are not permissible.  → The output amplifier is set to the maximum voltage specified by the next command; higher voltages are not permissible. The current output voltage is attained with the smaller digital values of the D/A converter. Setting the analog hardware is not required for changing the output voltage. Advantage: fast level changes and better transient response.	<b>2.5.2 GEN panel</b> Volt Range → AUTO → FIX
<b>SOURCE:VOLTage:LIMit[:AMPLitude]</b>	<b>&lt;nu&gt;</b> 0 to 20 V	V	Output voltage limit for command SOUR:VOLT:RANGE:AUTO OFF preventing too high voltages to be entered.	<b>2.5.2 GEN panel</b> For Volt Range = AUTO, Max Volt is displayed, for Volt Range = FIX, a numeric value.

Command	Parameter	Basic unit	Meaning	Section
<b>SOURCE:FREQUENCY:REFERENCE</b>	<nu> 1 MHz to 1 MHz	Hz	Reference frequency	2.5.2 <b>GEN panel</b> Ref.Freq
<b>SOURCE:VOLTAGE:REFERENCE</b>	<nu> 1 $\mu$ V to 1 MV	V	Reference voltage	2.5.2 <b>GEN panel</b> Ref.Volt
<b>OUTPUT</b>	<b>ON</b>  <b>OFF</b>		<p>→ Switches all outputs on. After an overload of analyzer inputs (input voltage into 300 <math>\Omega</math> and 600 <math>\Omega</math> above 25 V), the input impedance is automatically switched to 200 k<math>\Omega</math> to protect the analyzer input and the generator output is switched off. This command switches the generator on again and measurements can be continued provided the overvoltage is eliminated or the input impedance switched to 200 k<math>\Omega</math> (INP:IMP R200K).</p> <p>The overload protection of the analyzer inputs is valid for analog board versions <math>\geq</math> 4.00 and software versions <math>\geq</math> 1.0.</p> <p>→ Switches all outputs off including clock lines of digital interfaces. See 2.13 Fast Switch-off of Outputs.</p>	2.13 Taste OUTPUT OFF

## 3.10.1.3 Configuration of Digital Generators

Command	Parameter	Basic unit	Meaning	Section
<b>SOURCE:Digital:FEED</b>	<b>ADATa</b> <b>JITTer</b> <b>PHASe</b> <b>COMMON</b>		Use of generator data: → Generator controls the audio content of the output → Generator controls the jitter modulator of the digital interface → Same as JITTER with additional phase offset. → Generator controls common-mode voltage at digital output	2.5.3 <b>GEN panel</b> Src Mode → AUDIO DATA → JITTER ONLY → PHASE → COMMON ONLY
<b>SOURCE:Digital:SYNC:DELay</b>	<nu>	UI see 2.5.3.1	Setting a phase offset for SOUR:DIG:FEED JPPhase	2.5.3.1 <b>GEN panel</b> Phase ToRef
<b>OUTPUT:SElect</b>	<b>OFF</b> <b>CH1</b> <b>CH2</b> <b>CH2Is1</b>		→ Generator channels off → Only generator channel 1 active → Only generator channel 2 active → Both generator channels active and in phase	2.5.3 <b>GEN panel</b> Channel(s) → OFF → 1 → 2 → 2 ≡ 1
<b>OUTPUT:Digital:UNBalanced:FEED</b>	<b>AOUTput</b> <b>AINP.ut</b>		→ Same channel present at BNC and XLR connectors → Input signal through-connected and output at BNC connector	2.5.3 <b>GEN panel</b> Unbal Out → AUDIO OUT → AUDIO IN
<b>OUTPUT:Digital:CSIMulator</b>	<b>OFF</b> <b>SIMLong</b>		A 100-m cable of 110-Ω nominal impedance is simulated and cut into the generator output. → Cable simulation switched off → Cable simulation switched on	2.5.3 <b>GEN panel</b> Cable Sim → OFF → LONG CABLE

Command	Parameter	Basic unit	Meaning	Section
<b>SOURCE:Digital:SYNC:SOURCE</b>	<b>GCLock</b> <b>AINPut</b> <b>RINPut</b> <b>SINPut</b>		→ The clock is generated in the UPL. Selectable: 32, 44.1 or 48 kHz and 27 to 55 kHz variable. → Generator clock from analyzer input. → Generator clock from rear reference input → Generator clock controlled via rear BNC connector. The mark-to-space ratio can be set with command SOUR:DIG:SYNC:MODE to .	2.5.3 <b>GEN panel</b> Sync Out → GEN CLK → AUDIO IN → REF IN → SYNC IN
<b>SOURCE:Digital:SYNC:MODE</b>	<b>V50</b> <b>V60</b> <b>WCLock</b> <b>IWCLock</b> <b>F7024</b>		→ The generator sampling rates of 32, 44.1 and 48 kHz are synchronized to the 50-Hz video repetition rate. → Same as V50, but for 60 Hz (NTSC). → Generator directly synchronized to applied word clock using PLL. → Same as WCLock but with the inverted input used for synchronization. → Synchronization to a "customized clock", eg in the case of DAB	2.5.3 <b>GEN panel</b> Sync Mode → VIDEO 50 → VIDEO 60 → WORD CLK → WRD CLK INV → 1024 kHz
<b>OUTPUT:SAMPLE[:FREQUENCY]:MODE</b>	<b>F32</b> <b>F44</b> <b>F48</b> <b>F88</b> <b>F96</b> <b>EXTerm</b> <b>SYNChron</b> <b>VALue</b>		→ Sampling frequency 32 kHz (only with option UPL-B2 Digital Audio I/O, not with option UPL-B29 Digital Audio 96 kHz) → Sampling frequency 44.1 kHz → Sampling frequency 48 kHz → Sample freq. 88.2 kHz (only with option UPL-B29 Digital Audio 96 kHz in High Rate Mode CONF:DAI HRM) → Sample freq. 96 kHz (only with option UPL-B29 Digital Audio 96 kHz in High Rate Mode CONF:DAI HRM) → External sample frequency. Refer to next command for input values. → Sampling frequency synchronized to analyzer. → Sampling frequency entered with next command.	2.5.3 <b>GEN panel</b> Sample Freq → 32 kHz → 44.1 kHz → 48 kHz → 88.2 kHz → 96 kHz → EXTERN → SYNCHRON → VALUE:
<b>OUTPUT:SAMPLE:FREQUENCY</b>	<nu> 27 kHz to 55 kHz 40 kHz to 106 kHz	Hz	External sample frequency for digital instrument. Option UPL-B2 (Digital Audio I/O) Option UPL-B29 (Digital Audio 96 kHz)	2.5.3 <b>GEN panel</b>



Command	Parameter	Basic unit	Meaning	Section
<b>OUTPUT:Digital:SYNC:FEED</b>	<i>AIPut</i> <i>GCLock</i> <i>RINPut</i> <i>SPLL</i>		Specifies the signal to be output at rear BNC connector for synchronization. → Audio input signal output without clock processing. → Output of internal generator clock. → Same as GCLock, but reference input. → Audio input signal output after clock processing with internal PLL.	2.5.3 <b>GEN panel</b> Sync Out → AUDIO IN → GEN CLK → REF IN → SYNC PLL
<b>OUTPUT:Digital:SYNC:TYPE</b>	<i>WCLock</i> <i>BCLock</i>		Specifies the signal type for OUTPUT:Digital:SYNC:FEED ..... → Sampling frequency → 128 times the sampling frequency	2.5.3 <b>GEN panel</b> Type → WORD CLK → BIPHASE CLK
<b>OUTPUT:Digital:REFERENCE:FEED</b>	<i>AINPut</i> <i>AINReclock</i> <i>AOUTput</i> <i>RGENerator</i>		Specifies the signal to be output at the Ref-Out connector. → The input is throughconnected. → The input signal is output again; the clock is processed via PLL using the internal clock ("jitter suppression"). → The same signal as on the front panel is output. → Reference generator output. For an output with phase the reference is defined.	2.5.3 <b>GEN panel</b> Ref Out → AUDIO IN → AUD IN RCLK → AUDIO OUT → REF GEN
<b>SOURCE:Digital:REFERENCE</b>	<i>AZERO</i> <i>AONE</i>		All data of the reference generator are → 0 → 1	2.5.3 <b>GEN panel</b> Data → ALL ZERO → ALL ONE
<b>SOURCE:VOLTage:LIMit[:AMPLitude]</b>	<nu> 0 to 1 FS	FS	Voltage limitation (for audio data only)	2.5.3 <b>GEN panel</b> Max Volt
<b>SOURCE:FREQUENCY:REFERENCE</b>	<nu> 1 MHz to 1 MHz	Hz	Reference frequency	2.5.3 <b>GEN panel</b> Ref.Freq

Command	Parameter	Basic unit	Meaning	Section
<b>SOURCE:Voltage:REFERENCE</b>	<nu> 10 nFS to 100 Fs	Hz	Reference level	2.5.3 <b>GEN panel</b> Ref Volt
<b>OUTPUT:AUDIObits</b>	<n> 8 to 24		Word length of audio samples in bits.	2.5.3 <b>GEN panel</b> Audio Bits
<b>OUTPUT:Signal: LEVEL</b>	<nu>	Vpp	Voltage at Unbal AES output	2.5.3 <b>GEN panel</b> Unbal Vpp
<b>OUTPUT:Signal:BALanced:LEVEL</b>	<nu> 0 to 8.5 V		Setting the output voltage of the digital signal at the BAL (XLR) interface. Peak-to-peak voltage upon termination with nominal impedance (110 Ω); without termination the voltage is twice as high. This voltage is always 4 times as high as the voltage at the UNBAL (BNC) interface.	2.5.3 <b>GEN panel</b> BAL Vpp

## 3.10.1.3.1 AES / EBU PROTOCOL Definition

Command	Parameter	Basic unit	Meaning	Section
<b>SOURCE:PROTOCOL</b>	<b>OFF</b>  <b>STATIC</b>  <b>Enhanced</b>		<p>→ If the generated channel status data are of no interest, the undesired menu lines are removed from the generator panel. Channel status data cannot be entered. The last-defined status remains unchanged.</p> <p>→ Only basic channel status data can be generated (RAW data identical in both channels have to be defined via a file with or without valid CRC)</p> <p>This mode can always be used without any restriction.</p> <p>→ Selectable only with option UPL-B21 (digital audio protocol) fitted. All protocol commands are displayed in the GENERATOR panel where the full scope of protocol data generation can be entered and displayed. Besides the valid CRC, local time code can also be generated, which is reset with generator start and automatically counted up.</p> <p>In this mode the analyzer must also be set to protocol analysis. Therefore, when switching on ENHANCED the following settings are made automatically in the analyzer panel:</p> <ul style="list-style-type: none"> <li>• INSTRUMENT DIGITAL (INST2 D48)</li> <li>• Meas Mode AUDIO DATA (SENS:DIG:FEED ADAT)</li> <li>• FUNCTION PROTOCOL (SENS:FUNC 'PROT')</li> </ul> <p>Conversely, this function is set to OFF as soon as one of the three named analyzer menu lines is changed.</p>	2.5.3.2 <b>ANA panel</b> PROTOCOL → PANEL OFF → STATIC → ENHANCED
<b>OUTPUT:VAL:idity</b>	<b>CH1And2</b> <b>NONE</b>		<p>Sets the validity bits in the AES/EBU data stream.</p> <p>→ Valid bit for both channels set. → Valid bit for none of the channels set</p>	2.5.3.2 <b>GEN panel</b> Validity
<b>SOURCE:PROTOCOL:LChannelstatus</b>	<b>ZERO</b> <b>AES3</b>  <b>CRC</b>  <b>RAW</b>		<p>Specifies how the channel status data for LEFT are to be generated.</p> <p>→ All channel status data bits are 0 → UPL generates local timecode and CRC. All other channel status data are defined by the file loaded with command MMEMory:LOAD:LPGC "<b>filename</b>".</p> <p>→ Same as AES3, however local timecode is not generated by UPL but set as a fixed value from the file.</p> <p>→ Same as AES3, however neither local timecode nor CRC is generated by UPL but set as fixed values from the file.</p>	2.5.3.2 <b>GEN panel</b> Ch Sta. L → ZERO → FILE+AES3 → FILE+CRC → FILE

Command	Parameter	Basic unit	Meaning	Section
<b>MMEMory:LOAD:LPGC</b>	"filename"		Stating a file containing channel status data for LEFT. Preset file type: *.pgc	2.5.3.2 <b>GEN panel</b> Filename
<b>SOURCE:PROTOCOL:RCHannel/status</b>	<b>ZERO</b> <b>LEQUAL</b> <b>AES3</b> <b>CRC</b> <b>RAW</b>		Specifies how the channel status data RIGHT are to be generated. → All channel status data bits are 0 → The two sides are identical, all definitions made for left are copied to the right side. The operating mode is defined by Ch. Stat L. → UPL generates local timecode and CRC. All other channel status data are defined by the file loaded with command MMEMory:LOAD:RPGC "filename". → Same as AES3, however local timecode not generated by UPL but set as a fixed value from the file. → Same as AES3, however neither local timecode nor CRC is generated by UPL but set as fixed values from the file.	2.5.3.2 <b>GEN panel</b> Ch Stat. R → ZERO → EQUAL L → FILE+AES3 → FILE+CRC → FILE
<b>MMEMory:LOAD:RPGC</b>	"filename"		Stating a file containing channel status data for RIGHT. Preset file type: *.prd	2.5.3.2 <b>GEN panel</b> Filename
<b>SOURCE:PROTOCOL:UMODE</b>	<b>ZERO</b> <b>FILE</b>		Specifies how user data are to be generated. → All user bits are initialized to be 0. → User bits are output according to the definitions in the file loaded with command MMEMory:LOAD:PGU "filename".	2.5.3.2 <b>GEN panel</b> User Mode → ZERO → FILE DEF
<b>MMEMory:LOAD:PGU</b>	"filename"		Stating a file containing USER data Preset data type: *.prd	2.5.3.2 <b>GEN panel</b> Filename

## 3.10.1.3.2 Auxiliary AUX GEN

Command	Parameter	Basic unit	Meaning	Section
<b>SOURCE2:FUNCTION</b>	<b>OFF</b> <b>ANLGout</b>  <b>COMMON</b>  <b>JITTER</b>		<p>→ Auxiliary generator switched off, audio data generated without interference signal, analog outputs switched off (high-impedance).</p> <p>→ Audio data generated without interference signal, an analog signal is generated at the analog XLR connectors in addition to the digital signal at the BAL, UNBAL and optical outputs.</p> <p>→ A common-mode interference signal is superimposed on the audio data, the analog outputs are switched off (high-impedance).</p> <p>→ Frequency and level of the interference signal can be set or swept</p> <p>→ A jitter signal is added to the audio signal, the analog outputs are switched off (high-impedance).</p> <p>→ Jitter frequency and level can be set or swept.</p> <p>Permissible only for digital generator in the Src Mode AUDIO DATA   PHASE (INST D48 with SOUR:DIG:FEED ADAT PHAS)</p>	<b>2.5.5 GEN panel</b> → OFF → ANALOG OUT → COMMON MODE → JITTER
<b>OUTPUT2:SELECT</b>	<b>OFF</b> <b>CH1</b> <b>CH2</b> <b>CH2/S1</b>		<p>Selection of output channel when the auxiliary generator is used as an analog generator (SOUR2:FUNC ANLG). The low-distortion generator is used, level control is via the output amplifier.</p> <p>→ Both channels off</p> <p>→ Channel 1 on, channel 2 off</p> <p>→ Channel 2 on, channel 1 off</p> <p>→ Same signal on both channels</p>	<b>2.5.5 GEN panel</b> Channel(s) → OFF → 1 → 2 → 2 ≡ 1
<b>OUTPUT2:TYPE</b>	<b>UNBalanced</b> <b>BALanced</b>		<p>Selection of output channel when the auxiliary generator is used as an analog generator (SOUR2:FUNC ANLG).</p> <p>→ An unbalanced signal is generated at the XLR connector; the maximum output level is 10 V.</p> <p>→ A balanced signal is generated at the XLR connector, the maximum output level is 20 V. The output impedance can be selected in three steps with the subsequent command.</p>	<b>2.5.5 GEN panel</b> Output → UNBAL → BAL

Command	Parameter	Basic unit	Meaning	Section
<b>OUTPut2:IMPedance</b>	R10 R200 R600		Selection of output impedance when the auxiliary generator is used as an analog generator (SOUR2:FUNC ANLG) and OUTP2:TYPE BAL is selected; the output impedance of the unbalanced output is generally 5 $\Omega$ . → 10 $\Omega$ → 200 $\Omega$ → 600 $\Omega$	<b>2.5.5 GEN panel</b> Impedance → 10 $\Omega$ → 200 $\Omega$ → 600 $\Omega$
<b>SOURce2:SWEEp ...</b>			The auxiliary generator has its own sweep system which is similar to that of the function generator. 2-dimensional sweep, ie simultaneous frequency and level sweep, is not implemented. <b>The commands permissible for the auxiliary generator are listed in section 3.10.1.4.1 Sweep Settings for Auxiliary Generator (AUX GEN).</b>	<b>2.5.4.2 GEN-Panel</b>
<b>SOURce2:FREQUency[:CW FIXed]</b>	<nu> 10 Hz to 110 kHz	Hz	For SOUR2:FUNC ANLG: Entry of sinewave frequency of analog signal For SOUR2:FUNC COMM: Entry of common-mode frequency For SOUR2:FUNC JITT: Entry of jitter frequency	<b>2.5.5 GEN panel</b> Depending on AUX GEN: → Anlg Freq → Comm Freq → JittPkFreq
<b>SOURce2:VOLTage[:LEVel AMPLitude]</b>	<nu> 0 to 7.07 V 0 to 7.07 V 0 to 250 mUI	V V UI	For SOUR2:FUNC ANLG: Entry of sinewave amplitude of analog signal For SOUR2:FUNC COMM: Entry of common-mode amplitude For SOUR2:FUNC JITT: Entry of jitter-peak amplitude	<b>2.5.5 GEN panel</b> Depending on AUX GEN: → Anlg Ampl → Comm Ampl → JittPkAmpl

## 3.10.1.4 Generator Sweeps

## 3.10.1.4.1 Sweep Settings for Auxiliary Generator (AUX GEN)

Command	Parameter	Basic unit	Meaning	Section
<b>SOURce2:SWEep:MODE</b>	MANual AUTO		Auxiliary generator: → Manual sweep trigger → Automatic sweep trigger	2.5.4.2 Sweeps GEN panel Sweep Ctrl
<b>SOURce2:SWEep:NEXTstep</b>	DWELI ASYNc LIST		Auxiliary generator: → Sweep trigger at fixed preset time → Sweep triggered when a valid result is obtained → Sweep trigger is time-controlled by interpolated list value Permissible for AUTO SWEEP and AUTO LIST only (SOUR2:SWE:MODE AUTO;SOUR2:FREQ VOLT:MODE SWE1 LIST1)	2.5.4.2 Sweeps GEN panel Next Step → ANLR SYNC → DWELL VALUE → DWELL FILE
<b>SOURce2:SWEep:DWELI</b>	<nu> 10 ms to 1000 s	s	Auxiliary generator: Dwell time for each sweep step Permissible for SOUR2:SWE:NEXT DWEL only.	2.5.4.2 Sweeps GEN panel Dwell
<b>MMEMory:LOAD:LIST</b>	DWELI2;'filename' Query: MMEM:LOAD:LIST? DWEL2		Specified file contains dwell times Permissible for SOUR2:SWE:NEXT LIST only	2.5.4.2 Sweeps GEN panel Dwell File
<b>SOURce2:FREQUENCY:MODE</b>	CW   FIXed SWEep1 LIST1		Auxiliary generator: → Frequency setting by entry using command SOUR2:FREQ <nu> → Frequency setting for X axis via normal sweep → Frequency setting for X axis via list sweep	2.5.4.2 Sweeps GEN panel SWEEP CTRL X Axis

Command	Parameter	Basic unit	Meaning	Section
<b>SOURCE2:SWEep:FREQUENCY:SPACING</b>	LINear LOGarithmic		Auxiliary generator: Division of sweep range for - frequency sweep of analog signal (SOURCE2:FUNC ANLG) - common-mode frequency sweep (SOURCE2:FUNC COMM) - jitter frequency sweep (SOURCE2:FUNC JITT) → linear → logarithmic  Permissible for SOURCE:FREQ:MODE SWE1 only	<b>2.5.4.2 Sweeps</b> <b>GEN panel</b> Spacing → LIN → LOG
<b>SOURCE2:FREQUENCY:START</b>	<nu> 10 Hz to 110 kHz	Hz	Auxiliary generator: Start value for frequency sweep  Permissible for SOURCE:FREQ:MODE SWE1 only	<b>2.5.4.2 Sweeps</b> <b>GEN panel</b> FREQUENCY Start
<b>SOURCE2:FREQUENCY:STOP</b>	<nu> 10 Hz to 110 kHz	Hz	Auxiliary generator: Stop value of frequency sweep  Permissible for SOURCE:FREQ:MODE SWE1 only	<b>2.5.4.2 Sweeps</b> <b>GEN panel</b> FREQUENCY Stop
<b>SOURCE2:SWEep:FREQUENCY:POINTS</b>	<n> 2 to 1024		Auxiliary generator: Number of sweep points of frequency sweep  Permissible for SOURCE:FREQ:MODE SWE1 only	<b>2.5.4.2 Sweeps</b> <b>GEN panel</b> FREQUENCY Points
<b>SOURCE2:SWEep:FREQUENCY:STEP</b>	<nu> depending on START and STOP	Hz	Auxiliary generator: Step width of frequency sweep  Permissible for SOURCE:FREQ:MODE SWE1 only	<b>2.5.4.2 Sweeps</b> <b>GEN panel</b> FREQUENCY Step
<b>MMEMory:LOAD:LIST</b>	FREQUENCY2,'file'  Query MMEM:LOAD:LIST? FREQ2		File containing frequency values  Permissible for SOURCE2:SWE:MODE AUTO MAN::SOURCE2:FREQ:MODE LIST1 only	<b>2.5.4.2 Sweeps</b> <b>GEN panel</b> FREQ FILE
<b>SOURCE2:VOLTage:MODE</b>	CW   FIXed SWEep1 LIST1		Auxiliary generator: → Amplitude setting by entry using command SOURCE2:VOLT <nu> → Amplitude setting via normal sweep, amplitude as X axis → Amplitude setting via list sweep, amplitude as X axis	<b>2.5.4.2 Sweeps</b> <b>GEN panel</b> SWEEP CTRL X Axis



Command	Parameter	Basic unit	Meaning	Section
<b>SOURCE2:SWEEP:VOLTage:SPACING</b>	<b>LINear</b> <b>LOGarithmic</b>		Auxiliary generator: Division of sweep range for - sine wave amplitude of analog signal (SOURCE2:FUNC ANLG) - common-mode amplitude (SOURCE2:FUNC COMM) - jitter-peak amplitude (SOURCE2:FUNC JITT) → linear → logarithmic  Permissible for SOURCE2:VOLT:MODE SWE1 only	<b>2.5.4.2 Sweeps</b> <b>GEN panel</b> VOLTAGE   AMPL Spacing → LIN → LOG
<b>SOURCE2:VOLTage:START</b>	<b>&lt;nu&gt;</b> 0 to 7.07 V 0 to 7.07 V 0 to 250 mUI	V V UI	Auxiliary generator: Start value for amplitude sweep  Permissible for SOURCE2:VOLT:MODE SWE1 only	<b>2.5.4.2 Sweeps</b> <b>GEN panel</b> VOLTAGE   AMPL Start
<b>SOURCE2:VOLTage:STOP</b>	<b>&lt;nu&gt;</b> 0 to 7.07 V 0 to 7.07 V 0 to 250 mUI	V V UI	Auxiliary generator: Stop value for amplitude sweep  Permissible for SOURCE2:VOLT:MODE SWE1 only	<b>2.5.4.2 Sweeps</b> <b>GEN panel</b> VOLTAGE   AMPL Stop
<b>SOURCE2:SWEEP:VOLTage:POINTS</b>	<b>&lt;n&gt;</b> 2 to 1024		Auxiliary generator: Number of sweep points of amplitude sweep  Permissible for SOURCE2:VOLT:MODE SWE1 only	<b>2.5.4.2 Sweeps</b> <b>GEN panel</b> VOLTAGE   AMPL Points
<b>SOURCE2:SWEEP:VOLTage:STEP</b>	<b>&lt;nu&gt;</b> depending on START and STOP	V FS	Auxiliary generator: Step width for amplitude sweep  Permissible for SOURCE2:VOLT:MODE SWE1 only	<b>2.5.4.2 Sweeps</b> <b>GEN panel</b> VOLTAGE   AMPL Step
<b>MEMORY:LOAD:LIST</b>	<b>VOLTage2,'filename'</b>  Query: MMEM:LOAD:LIST? VOLT2		File containing amplitude values  Permissible for SOURCE2:SWEEP:MODE AUTO MAN ;SOURCE2:VOLT:MODE LIST1 only	<b>2.5.4.2 Sweepss</b> <b>GEN panel</b> VOLTAGE   AMPL VOLT FILE

### 3.10.1.4.2 Sweep Settings for Generator Functions SINusoid, STEReo, BURSt, S2Pulse, MDISt, DFD and DC

- With a SINusoid, STEReo or DC sweep the sinusoidal frequency and/or the level is swept.
- With a BURSt and S2Pulse sweep the burst frequency and/or the level is swept, likewise OnTime and/or interval (see next section).
- With a MDISt sweep the upper frequency and/or the total voltage is swept.
- With a DFD sweep the center frequency and/or the total voltage is swept.

See 3.10.1.4.4 Which parameters can be swept?

Command	Parameter	Basic unit	Meaning	Section
<b>SOURce:SWEEp:MODE</b>	MANual AUTO		→ Manual sweep switching → Automatic sweep switching	2.5.4.1.3 GEN panel Sweep Ctrl
<b>SOURce:SWEEp:NEXtstep</b>	DWELl ASYNc LIST		→ Sweep after a certain (fixed) time has elapsed → Sweep after a valid measured value has been obtained → Sweep after a certain time defined by interpolated list value	2.5.4.1.3 GEN panel Next Step → ANLR SYNC → DWELL VALUE → DWELL FILE
<b>SOURce:SWEEp:DWELl</b>	<n> 10 ms to 1000 s	s	Dwell time per sweep	2.5.4.1.3 GEN panel Dwell
<b>MMEMory:LOAD:LIST</b>	DWELl,'filename' Query: MMEM:LOAD:LIST? DWEL		Specified file contains the dwell times	2.5.4.1.3 GEN panel Dwell File
<b>SOURce:FREQUency:MODE</b>	CW   FIXed SWEEp1 SWEEp2 LIST1 LIST2		→ Frequency setting via entry → Frequency setting via normal sweep; frequency as X axis → Frequency setting via normal sweep; frequency as Z axis → Frequency setting via list sweep; frequency as X axis → Frequency setting via list sweep; frequency as Z axis	2.5.4.1.3 GEN panel SWEEP CTRL X Axis Z Axis

Command	Parameter	Basic unit	Meaning	Section
<b>SOURCE:FREQUENCY:START</b>	<nu> Value range determined by instrument or function	Hz	Start value for frequency sweep See 3.10.1.4.4 Which parameters can be swept?	2.5.4.2 GEN panel FREQUENCY → Start
<b>SOURCE:FREQUENCY:STOP</b>	<nu> Value range determined by instrument or function	Hz	Stop value for frequency sweep	2.5.4.2 FREQUENCY → Stop
<b>SOURCE:SWEep:FREQUENCY:POINTS</b>	<n> 2 to 1024		For analog instrument Number of sweep points for frequency sweep	2.5.4.2 GEN panel Points
<b>SOURCE:SWEep:FREQUENCY:SPACING</b>	LInear LOGarithmic		Scaling of frequency sweep range → linear → logarithmic	2.5.4.2 GEN panel Spacing
<b>SOURCE:SWEep:FREQUENCY:STEP</b>	<nu>	Hz	Step width for frequency sweep	2.5.4.2 GEN panel Step
<b>MEMORY:LOAD:LIST</b>	FREQUENCY[1] "filename" Query: MMEM:LOAD:LIST? FREQ,		File containing frequencies	2.5.4.2 GEN panel FREQ FILE
<b>SOURCE:VOLTage:MODE</b>	CW   FIXed SWEep1 SWEep2 LIST1 LIST2		→ Amplitude setting via entry → Amplitude setting via normal sweep; amplitude as X axis → Amplitude setting via normal sweep; amplitude as Z axis → Amplitude setting via list sweep; amplitude as X axis → Amplitude setting via list sweep; amplitude as Z axis	2.5.4.2 GEN panel SWEEEP CTRL X Axis Z Axis
<b>SOURCE:VOLTage:START</b>	<nu> Value range determined by instrument or function	V FS	Start value for amplitude sweep See 3.10.1.4.4 Which parameters can be swept?	2.5.4.2 GEN panel VOLTAGE → Start

Command	Parameter	Basic unit	Meaning	Section
<b>SOURCE:VOLTage:STOP</b>	<nu> Value range determined by instrument or function	V FS	Stop value for amplitude sweep	2.5.4.2 GEN panel VOLTAGE → Stop
<b>SOURCE:SWEep:VOLTage:POINTS</b>	<n> 2 to 1024		Number of sweep points for amplitude sweep	2.5.4.2 GEN panel Points
<b>SOURCE:SWEep:VOLTage:SPACING</b>	LInear LOGarithmic		Scaling of amplitude sweep range → linear → logarithmic	2.5.4.2 GEN panel Spacing → LIN → LOG
<b>SOURCE:SWEep:VOLTage:STEP</b>	<nu> Value range determined by instrument or function	V FS	Step width for amplitude sweep	2.5.4.2 GEN panel Step
<b>MMEMory:LOAD:LIST</b>	VOLTage,'filename'  Query: MMEM:LOAD:LIST? VOLT		File containing amplitude values	2.5.4.2 GEN panel VOLT FILE
<b>SOURCE:OFF:MODE</b>	SWEep2   LIST2		Switches a Z sweep off which was switched on with one of the following commands. SOURCE:FREQUENCY:MODE SWEep2 / LIST2 or SOURCE:VOLTage:MODE SWEep2 / LIST2 or SOURCE:ONTime:MODE SWEep2 / LIST2 or SOURCE:INTERval:MODE SWEep2 / LIST2 SWEep2 and LIST2 are synonyms in this command	2.5.4.2 GEN panel Z Axis → OFF

**Note:** Max. 2 sweep parameters can be selected not to equal CW (= FIXed). Combining SWEep and LIST is not permissible. Likewise, assignment of the same selection point (eg SWEep1) to different sweep parameters is not permissible; the selection made most recently is valid, the other sweep parameters are set to FIXed.

A normal sweep (or list sweep) is possible only when exactly 1 sweep parameter is set to SWEep1 (or LIST1).  
The sweep system is switched off when all sweep parameters are set to CW (=FIXed).  
Value range for "START", "STOP": values are specified in the functions section.

### 3.10.1.4.3 Sweep Settings for Generator Functions BURSt and S2Pulse

Sweep settings same as with SINusoid, but for BURSt and S2Pulse **Ontime** and **Interval** may be swept in addition see 3.10.1.4.4 Which parameters can be swept?:

Command	Parameter	Basic unit	Meaning	Section
<b>SOURCE:ONTIME:MODE</b>	CW   FIXed SWEep1 SWEep2 LIST1 LIST2		→ Burst time setting via entry → Burst time setting via normal sweep; burst time as X axis → Burst time setting via normal sweep; burst time as Z axis → Burst time setting via list sweep; burst time as X axis → Burst time setting via list sweep; burst time as Z axis	<b>2.5.4.2</b> <b>GEN panel</b> SWEEEP CTRL X Axis Z Axis
<b>SOURCE:INTERVAL:MODE</b>	CW   FIXed SWEep1 SWEep2 LIST1 LIST2		→ Interval setting via entry → Interval setting via normal sweep; interval as X axis → Interval setting via normal sweep; interval as Z axis → Interval setting via list sweep; interval as X axis → Interval setting via list sweep; interval as Z axis	<b>2.5.4.2</b> <b>GEN panel</b> SWEEEP CTRL X Axis Z Axis
<b>SOURCE:ONTIME:START</b>	<nu> Value range determined by instrument or function	s, cyc	Start value for burst time sweep See 3.10.1.4.4 Which parameters can be swept?	<b>2.5.4.2</b> 2.5.4.5 2.5.4.6 <b>GEN panel</b> Start
<b>SOURCE:ONTIME:STOP</b>	<nu> Value range determined by instrument or function	s, cyc	Stop value for burst time sweep	<b>2.5.4.2</b> 2.5.4.5 2.5.4.6 <b>GEN panel</b> Stop
<b>SOURCE:SWEep:ONTIME:POINTS</b>	<n> 2 to 1024		Number of sweep points of burst time sweep	<b>2.5.4.2</b> <b>GEN panel</b> Points

Command	Parameter	Basic unit	Meaning	Section
<b>SOURCE:SWEEP:ONTime:SPACING</b>	<b>LINear</b> <b>LOGarithmic</b>		Scaling of burst time sweep range → linear → logarithmic	<b>2.5.4.2</b> <b>GEN panel</b> Spacing → LIN → LOG
<b>SOURCE:SWEEP:ONTime:STEP</b>	<b>&lt;nu&gt;</b> Value range determined by instrument or function	s, cyc	Step size for burst time sweep	<b>2.5.4.2</b> <b>GEN panel</b> Step
<b>MMEMory:LOAD:LIST</b>	<b>ONTime,'filename'</b> Query: MMEM:LOAD:LIST? ONT		File containing burst time values	2.5.4.5 2.5.4.6 <b>GEN panel</b> ONTIM FILE
<b>SOURCE:INTERVAL:START</b>	<b>&lt;nu&gt;</b> Value range determined by instrument or function	s	Start value for interval sweep  See 3.10.1.4.4 Which parameters can be swept?	<b>2.5.4.2</b> 2.5.4.5 2.5.4.6 <b>GEN panel</b> Start
<b>SOURCE:INTERVAL:STOP</b>	<b>&lt;nu&gt;</b> Value range determined by instrument or function	s	Stop value for interval sweep	<b>2.5.4.2</b> 2.5.4.5 2.5.4.6 <b>GEN panel</b> Stop
<b>SOURCE:SWEEP:INTERVAL:POINTS</b>	<b>&lt;n&gt;</b> 2 to 1024		Number of sweep points for interval sweep	<b>2.5.4.2</b> <b>GEN panel</b> Points
<b>SOURCE:SWEEP:INTERVAL:SPACING</b>	<b>LINear</b> <b>LOGarithmic</b>		Scaling of interval sweep range → linear → logarithmic	<b>2.5.4.2</b> <b>GEN panel</b> Spacing → LIN → LOG

Command	Parameter	Basic unit	Meaning	Section
<b>SOURCE:SWEEP:INTERVAL:STEP</b>	<nu> Value range determined by instrument or function	s	Step size for interval sweep	2.5.4.2 GEN panel Step
<b>MEMORY:LOAD:LIST</b>	INTERVAL, 'filename' Query: MMEM:LOAD:LIST? INT		File containing interval values	2.5.4.5 2.5.4.6 GEN panel INTV FILE

### 3.10.1.4.4 Which parameters can be swept?

Generator Funktion	FREQ-Sweep	VOLT-Sweep	ON TIME-Sweep	INTERVAL-Sweep
<b>SINusoid</b>	Sine frequency	Sine amplitude	---	---
<b>STEReo</b>	If SOUR:FREQ:SEL FQPH selected: Common sine frequency for both channels may be swept If SOUR:FREQ:SEL FQFQ selected: Sine frequency of left channel may be swept. Sine frequency of right channel remains constant.	If SOUR:VOLT:SEL VLRT selected: The levels of the left (CH1) and right channel (CH2) may be swept and have a fixed offset. The offset remains constant during level sweep. The level offset can be set with SOUR:VOLT:RAT <n> If SOUR:VOLT:SEL VLVL selected:	---	---

			The sine amplitude of the left channel (CH1) may be swept. The sine amplitude of right channel (CH2) remains constant during sweep.		
<b>BURSt</b>	Sine frequency	Burst amplitude (amplitude during HIGH phase of signal)	Burst duration, the time during which the sine has ist high level.	Burst interval length.	
<b>S2Pulse</b>	Burst frequency	Burst amplitude (amplitude during HIGH phase of signal)	Burst duration, the time during which the sine has ist high level.	Burst interval length.	
<b>MDISt</b>	Useful frequency	Total amplitude of both sinewave signals	---	---	
<b>DFD</b>	Center frequency	Total amplitude of both sinewave signals	---	---	
<b>DC</b>	---	DC voltage	---	---	



## 3.10.1.5 Generator Functions

Command	Parameter	Basic unit	Meaning	Section
<b>SOURCE:FUNCTION[:SHAPE]</b>	<b>SIN</b> usoid <b>STEREO</b> MULTisine <b>BURST</b> <b>S2P</b> ulse <b>MDIST</b> <b>DFD</b> <b>RANDOM</b> <b>USER</b> <b>POL</b> arity <b>FSK</b> <b>FM</b> <b>DC</b>		Generator signal: → Sinusoidal tone → Stereo signal → Multi-tone (up to 17 sine lines) → Sine burst → Sine <sup>2</sup> burst → Double sine (similar to SMPTE) → Double sine (difference frequency distortion method) → Noise → User-defined signals → Polarity test signal → Frequency shift keying → Modulated sine → DC Voltage	2.5.4 <b>GEN panel</b> <b>FUNCTION</b> → SINE → STEREO SINE → MULTISINE → SINE BURST → SINE <sup>2</sup> BURST → MOD DIST → DFD → RANDOM → ARBITRARY → POLARITY → FSK → MODULATION → DC

## 3.10.1.5.1 SINE

Command	Parameter	Basic unit	Meaning	Section
<b>SOURCE:FUNCTION[:SHAPE]</b>	<b>SINusoid</b>		→ Sinusoidal tone	2.5.4.3 <b>GEN panel</b> FUNCTION → SINE
<b>SOURCE:FREQUENCY:OFFSet:STATE</b>	<b>ON</b> <b>OFF</b>		→ Frequency offset 0.1 % → No frequency offset	2.5.4.1 <b>GEN panel</b> Frq. Offset
<b>SOURCE:VOLTage[:LEVel AMPLitude]:OFFSet:STATE</b>	<b>OFF</b> <b>ON</b>		DC offset permitting a DC voltage to be superimposed to the generator output. → Hardly any DC voltage at the output → DC voltage can be set with the next command. <b>Note:</b> <i>This setting cannot be made in the analog generator when a low-distortion generator is used.</i>	2.5.4.1 <b>GEN panel</b> DC Offset → OFF → ON
<b>SOURCE:VOLTage[:LEVel AMPLitude]:OFFSet</b>	<b>&lt;n&gt;</b> -5 V to 5 V -10 V to 10 V -1FS to 1FS	V FS	DC amplitude Analog instrument (OUTP:TYPE UNB) Analog instrument (OUTP:TYPE BAL) Digital instrument	2.5.4.1 <b>GEN panel</b> DC Offset
<b>SOURCE:SINusoid:DITHer:STATE</b>	<b>ON</b> <b>OFF</b>		→ Noise superimposed on signal → Noise superimposition off For digital instrument only	2.5.4.1 <b>GEN panel</b> Dither → ON → OFF
<b>SOURCE:SINusoid:DITHer</b>	<b>&lt;nu&gt;</b> 0 to 1 FS	FS	Noise amplitude	2.5.4.1 <b>GEN panel</b> Dither

Command	Parameter	Basic unit	Meaning	Section
<b>SOURCE:RANDOM:PDF</b>	GAUSSian TRIangle RECTangle		→ Noise distribution, Gaussian → Noise distribution, triangular → Noise distribution, uniform	2.5.4.1 <b>GEN panel</b> PDF → GAUSS → TRIANGLE → RECTANGLE
<b>SOURCE:LOWDistortion</b>	ON OFF		→ Sine signal generated by LDG → Sine signal generated by function generator  Only available with ANALOG generator and option UPL-B1 (Low Distortion Generator)	2.5.4.1 2.5.4.3 <b>GEN panel</b> Low Dist → ON → OFF
<b>SOURCE:SWEep ...</b>			For sweep commands see 3.10.1.4 Generator Sweeps	
<b>SOURCE:FREQUENCY[:CW FIXed]</b>	<nu> Value range determined by instrument or function	Hz	Sine frequency Can be used as sweep parameter	2.5.4.3 <b>GEN panel</b> FREQUENCY
<b>SOURCE:VOLTage:EQUALize:STATE</b>	ON OFF		→ Sine signal equalized → Sine signal not dependent on frequency	2.5.4.3 <b>GEN panel</b> Equalizer → ON → OFF
<b>MEMORY:LOAD:LIST</b>	<b>EQUALize,filename'</b>  Query: MMEM:LOAD:LIST? EQU		File containing equalizer data	2.5.4.3 <b>GEN panel</b> Equal.File
<b>SOURCE:VOLTage[:LEVel AMPLitude]</b>	<nu> 0 to 10 V 0 to 20 V 0 to 1 FS	V V FS	Sine amplitude Can be used as sweep parameter Analog range (OUTP:TYPE UNB) Analog range (OUTP:TYPE BAL) Digital range  Is voltage-limited by SOUR:VOLT:LIM see 3.10.1.2 and 3.10.1.3	2.5.4.3 <b>GEN panel</b> VOLTAGE

## 3.10.1.5.2 MULTISINE

Command	Parameter	Basic unit	Meaning	Section
<b>SOURCE:FUNCTION</b> [:SHAPE]	<b>MULT</b> sine		Multi-tone (up to 17 sine lines)	2.5.4.4 <b>GEN panel</b> FUNCTION → MULTISINE
<b>SOURCE:VOL T</b> age[:LEVel AMPLitude]: <b>OFFSet:STATE</b>	<b>OFF</b> <b>ON</b>		DC offset permitting a DC voltage to be superimposed on the generator output. → Virtually no DC voltage component at the output → DC voltage can be set with the next command. <b>Note:</b> <i>This setting cannot be made in the analog generator when a low-distortion generator is used.</i>	2.5.4.1.1 <b>GEN panel</b> DC Offset → OFF → ON
<b>SOURCE:VOL T</b> age[:LEVel AMPLitude]: <b>OFFSet</b>	<n> -5 V to 5 V -10 V to 10 V -1FS to 1FS	V V FS	DC amplitude Analog instrument (OUTP:TYPE UNB) Analog instrument (OUTP:TYPE BAL) Digital instrument	2.5.4.1.1 <b>GEN panel</b> DC Offset
<b>SOURCE:RANDom:SPACing:MODE</b>	<b>USER</b> defined <b>ATRack</b>		Setting the frequency spacing for the multisine measurement → The entered value (see next command) is corrected to the next settable value. → The value of the analyzer frequency spacing of FFT is automatically set it can be read out with command CALC:TRAN:FREQ:RES? provided FFT is selected in the analyzer.	2.5.4.4 <b>GEN panel</b> Spacing → USER DEF → ANLR TRACK
<b>SOURCE:RANDom:SPACing:FREQUENCY</b>	<nu> Lower limit value: analog = 2.93 Hz digital = sampling frequency / 16384	Hz	Setting value for frequency spacing for multisine measurement The value range depends on the selected generator and its sampling rate (see 2.5.1 Selecting the Generator)	2.5.4.4 <b>GEN panel</b> Spacing

Command	Parameter	Basic unit	Meaning	Section
<b>SOURCE:FUNCTION:MODE</b> alias <b>SOURCE:MULTisine:MODE</b>	<b>EQUALvoltage</b> <b>DEFInedvoltage</b>		Selection of entry mode for individual multisine voltages: → The same amplitude applies for each sine. It is entered with command SOUR:VOLT1 <nu>. → A separate amplitude can be defined for each sine.	2.5.4.4 <b>GEN panel</b> Mode → EQUAL VOLT → DEFINE VOLT
<b>SOURCE:VOLTage:EQUALizer:STATE</b>	<b>ON</b> <b>OFF</b>		See 2.5.4.1.3 Equalization of SINE, SINE BURST, DFD, MULTISINE, RANDOM → Every active multisine frequency line is equalized. Equalizer is switched on. The menu item "Equal. file" is activated, ie the indicated file is loaded. → The levels of all frequency lines remain unchanged.	2.5.4.4 <b>GEN panel</b> Equalizer → ON → OFF
<b>MEMORY:LOAD:LIST</b>	<b>EQUALizer, 'filename'</b> Query: MMEM:LOAD:LIST? EQU		Equalizer file for correcting the multisine frequency lines. Only with SOUR:VOLT:EQ:STAT ON selected, see 2.5.4.1.3 Equalization of SINE, SINE BURST, DFD, MULTISINE, RANDOM	2.5.4.4 <b>GEN panel</b> Equal.File
<b>SOURCE:MULTisine:COUNT</b>	<n> 1 to 17		Number of settable frequencies	2.5.4.4 <b>GEN panel</b> No of Sin
<b>SOURCE:VOLTage:CREStfactor:MODE</b>	<b>MINimized</b> <b>DPHase</b> <b>VALue</b>		→ The crest factor (ratio of peak/rms value) is minimized. → The phase of the lines can be separately set with the next but one command SOURCE:PHASe[<i>]>]:ADJusT]. The start phase of the sinewave is entered. → The crest factor is set with the next command SOUR:VOLT:CRES <n> so that it closely approaches a settable value.	2.5.4.4 <b>GEN panel</b> Crest Fact → OPTIMIZED → DEFINE PHAS → VALUE
<b>SOURCE:VOLTage:CREStfactor</b>	<n> 1 to 100		The specified crest factor is approximated. This is the easier the more lines are used for optimization. Acc. to measurements in line with ANSI S3.42 a crest factor of 4 (= 12 dB) is recommended.	2.5.4.4 <b>GEN panel</b> Crest Fact

Command	Parameter	Basic unit	Meaning	Section
<b>SOURCE:PHASE</b> <i>[:ADJust]	<i> 1 to 17 <nu> 0 to 360 °		Entered phase: i-th sine phase; i = 2 to 17  The line is output starting with the specified phase. If 0° is entered, the line starts at 0 and then rises. If 90° is entered, the line starts with the specified voltage and then decreases.  For SOUR:VOLT:CRES:MODE DPHase only	2.5.4.4 <b>GEN panel</b> Phas No 1 to 17
<b>SOURCE:VOLTage</b> <i>[:LEVel AMPLitude]	1 to 17 <nu> Analog instrument OUTP:TYPE UNB 0 to 10 V Analog instrument OUTP:TYPE BAL 0 to 20 V Digital instrument 0 to 1 FS		Level entry for i-th multisine line Is voltage-limited by SOUR:VOLT:LIM see 3.10.1.2 and 3.10.1.3  The maximum amplitude can be set for SOUR<i>:VOLT only when all other sinewaves have an amplitude of 0. Otherwise, V <sub>max</sub> must be reduced by the sum of the remaining single voltages.	2.5.4.4 <b>GEN panel</b> Volt No 1 to 17
<b>SOURCE:FREQUENCY</b> <i>[:CW FIXed]	<i> 1 to 17 <nu> Value range determined by instrument or function	Hz	Frequency entry for the i-th multisine line	2.5.4.4 <b>GEN panel</b> Freq No 1 to 17
<b>SOURCE:VOLTage:TOTal:GAIN</b>	<nu>	dB	Subsequent amplification of all sine lines (<0 → attenuation); the upper range limit depends on individual rules for sine and sine frequencies as well as on SOUR:VOLT:LIM	2.5.4.4 <b>GEN panel</b> TOTAL GAIN
<b>SOURCE:VOLTage:TOTal:LEVel AMPLitude?</b>	<nu> Query only	V FS	Total peak amplitude; query only  With the single amplitudes being unknown, all sinewaves should be set explicitly to 0 before setting the maximum amplitude.  1. SOUR:MULT:MODE EQU 2. SOUR1:VOLT 0	2.5.4.4 <b>GEN panel</b> TOTAL PEAK

Command	Parameter	Basic unit	Meaning	Section
<b>SOURCE:VOLTage:TOTAL:RMS?</b>	<nu> Query only	V FS	Total RMS amplitude; query only	2.5.4.4 <b>GEN panel</b> TOTAL RMS
<b>SOURCE:AM:MODE</b>	<b>OFF</b> <b>SINusoid</b> <b>BURSt</b>		Selection of the type of modulation → The amplitude modulation is switched off, the generator signal is not modulated. → The generator signal is amplitude-modulated from 0% to -100% in the form of a sinewave. → The generator signal is switched on and off periodically.	2.5.4.4 <b>GEN-Panel</b> Ampl Var → OFF → SINE → BURST
<b>SOURCE:FREQUENCY:AM</b>	<nu> 1 $\mu$ Hz to $f_{max}$ $f_{max}$ depending on generator	Hz	Setting of the modulation frequency Available only with SINE modulation (SOUR:AM:MODE SIN)	2.5.4.4 <b>GEN-Panel</b> Mod Freq
<b>SOURCE:VOLTage:AM</b> <new>	<nu> -100% to 0%	PCT	Setting of the modulation deviation in % Available only with SINE modulation (SOUR:AM:MODE SIN)	2.5.4.4 <b>GEN-Panel</b> Variation
<b>SOURCE:ONTime</b>	<nu> tmin to tmax Analog generator: tmin= 20.83 $\mu$ s Digital generator: tmin= 1 / sample frequency tmax: 60 s – tmin	s	Entry of the burst duration (time, the sine is switched on) Available only with BURST modulation (SOUR:AM:MODE BURS)	2.5.4.4 <b>GEN-Panel</b> ON TIME
<b>SOURCE:INTERval</b>	<nu> set burst duration ... 60 s	s	Entry of the burst interval length (burst period), the sum of burst duration and break time. Available only with BURST modulation (SOUR:AM:MODE BURS)	2.5.4.4 <b>GEN-Panel</b> INTERVAL

## 3.10.1.5.3 SINE BURST

Command	Parameter	Basic unit	Meaning	Section
<b>SOURCE:FUNCTION</b> [:SHAPE]	<b>BURSt</b>		→ Sine burst	2.5.4.5 <b>GEN panel</b> FUNCTION → SINE BURST
<b>SOURCE:VOL Tage[:LEVel AMPLitude]:OFFSet:STATE</b>	<b>OFF</b> <b>ON</b>		DC offset permitting a DC voltage to be superimposed at the generator output. → Hardly any DC voltage at the output → DC voltage can be set with the next command. <b>Note:</b> <i>This setting cannot be made in the analog generator when a low-distortion generator is used.</i>	2.5.4.1.1 <b>GEN panel</b> DC Offset → OFF → ON
<b>SOURCE:VOL Tage[:LEVel AMPLitude]:OFFSet</b>	<n> -5 V to 5 V -10 V to 10 V -1FS to 1FS	V FS	DC amplitude Analog instrument (OUTP:TYPE UNB) Analog instrument (OUTP:TYPE BAL) Digital instrument	2.5.4.1.1 <b>GEN panel</b> DC Offset
<b>SOURCE:VOL Tage:EQUALize:STATE</b>	<b>ON</b> <b>OFF</b>		Equalization of the sine voltage of the bursted sinewave → Equalizer on → Equalizer off	2.5.4.1.1 <b>GEN-Panel</b> Equalizer → ON → OFF
<b>MEMORY:LOAD:LIST</b>	<b>EQUALize, 'filename'</b> Query form: MMEM:LOAD:LIST? EQU		File containing equalizer data	2.5.4.1.1 <b>GEN-Panel</b> Equal.File
<b>SOURCE:SWEep ...</b>			For sweep commands see 3.10.1.4 Generator Sweeps	



Command	Parameter	Basic unit	Meaning	Section
<b>SOURce:FREQUENCY</b> [:CW FIXed]	<nu> Voltage range determined by instrument or function	Hz	Sine frequency Can be used as sweep parameter	2.5.4.5 <b>GEN panel</b> FREQUENCY
<b>SOURce:VOLTage</b> [:LEVel AMPLitude]	<nu> 0 to 12 V 0 to 24 V 0 to 1 FS	V FS	Burst amplitude (amplitude during HIGH phase of signal) Can be used as sweep parameter Analog instrument (OUTPUP:TYPE UNB) Analog instrument(OUTP:TYPE BAL) Digital instrument Is voltage-limited by SOUR:VOLT:LIM see 3.10.1.2 and 3.10.1.3	2.5.4.5 <b>GEN panel</b> VOLTAGE
<b>SOURce:VOLTage:LOWLevel</b>	<nu> 0 to SOUR:VOLT	V %on FS %on	Amplitude during LOW phase of signal Analog instrument Digital instrument	2.5.4.5 <b>GEN panel</b> Low Level
<b>SOURce:ONTime</b> [:CW FIXed]	<nu> 0 to 60 s Value range determined by instrument or function	s, cyc	Burst time Can be used as sweep parameter	2.5.4.5 <b>GEN panel</b> ON TIME
<b>SOURce:INTERval</b> [:CW FIXed]	<nu> Value range determined by instrument or function	s	Interval time Can be used as sweep parameter	2.5.4.5 <b>GEN panel</b> INTERVAL
<b>SOURce:ONTime:DElay</b>	<nu> 0 to 60 s		Sets a start delay for SINE BURST and SINE <sup>2</sup> BURST.	2.5.4.5 2.5.4.6 <b>GEN panel</b> BurstOnDel

**Note:** Clock rate and  $f_{max}$  depend on generator (see 2.5.1 Selecting the Generator).

**Caution:** "SOUR:VOLT" is voltage-limited by SCPI command "SOUR:VOLT:LIM"

3.10.1.5.4 SINE<sup>2</sup> BURST

Command	Parameter	Basic unit	Meaning	Section
<b>SOURCE:FUNCTION</b> [:SHAPE]	<b>S2Pulse</b>		Sine <sup>2</sup> burst	2.5.4.6 <b>GEN panel</b> FUNCTION → SINE <sup>2</sup> BURST
<b>SOURCE:VOLTage[:LEVel AMPLitude]:OFFSet:STATE</b>	<b>OFF</b> <b>ON</b>		DC offset permitting a DC voltage to be superimposed at the generator output. → Hardly any DC voltage at the output → DC voltage can be set with the next command. <b>Note:</b> <i>This setting cannot be made in the analog generator when a low-distortion generator is used.</i>	2.5.4.1.1 <b>GEN panel</b> DC Offset → OFF → ON
<b>SOURCE:VOLTage[:LEVel AMPLitude]:OFFSet</b>	<b>&lt;nu&gt;</b> -5 V to 5 V -10 V to 10 V -1FS to 1FS	V FS	DC amplitude Analog instrument (OUTP:TYPE UNB) Analog instrument (OUTP:TYPE BAL) Digital instrument	2.5.4.1.1 DC Offset
<b>SOURCE:SWEep ...</b>			For sweep commands see 3.10.1.4 Generator Sweeps	2.5.4.7 <b>GEN panel</b>
<b>SOURCE:FREQUENCY[:CW FIXed]</b>	<b>&lt;nu&gt;</b> Value range determined by instrument or function	Hz	Burst frequency Can be used as sweep parameter	2.5.4.6 <b>GEN panel</b> FREQUENCY
<b>SOURCE:VOLTage[:LEVel AMPLitude]</b>	<b>&lt;nu&gt;</b> 0 to 12 V 0 to 24 V 0 to 1 FS	V FS	Burst amplitude Can be used as sweep parameter Analog instrument (OUTP:TYPE UNB) Analog instrument (OUTP:TYPE BAL) Digital instrument Is voltage-limited by SOUR:VOLT:LIM see 3.10.1.2 and 3.10.1.3 When negative amplitudes are entered the pulse is inverted.	2.5.4.6 <b>GEN panel</b> VOLTAGE

Command	Parameter	Basic unit	Meaning	Section
<b>SOURCE:ONT</b> <i>ime</i> [:CW][FIXed]	<nu> Value range determined by instrument or function	s .cyc	Burst time Can be used as sweep parameter	2.5.4.6 <b>GEN panel</b> ON TIME
<b>SOURCE:INT</b> <i>erva</i> [:CW][FIXed]	<nu> Value range determined by instrument or function	s	Interval time Can be used as sweep parameter	2.5.4.6 <b>GEN panel</b> INTERVAL
<b>SOURCE:ONT</b> <i>ime:DEL</i> ay	<nu> 0 to 60 s		Sets a start delay for SINE BURST and SINE <sup>2</sup> BURST.	2.5.4.5 2.5.4.6 <b>GEN panel</b> BurstOnDel

## 3.10.1.5.5 MOD DIST

Command	Parameter	Basic unit	Meaning	Section
<b>SOURCE:FUNCTION</b> [:SHAPE]	<i>MDIS</i> t		→ Double sine (similar to SMPTE)	2.5.4.7 <b>GEN panel</b> FUNCTION → MOD DIST
<b>SOURCE:FREQUENCY:OFFSet:STATE</b>	ON OFF		→ Frequency offset 0.1 % → No frequency offset	2.5.4.1.1 <b>GEN panel</b> Frq. Offset → +1000 PPM → OFF
<b>SOURCE:VOLTage[:LEVel AMPLitude]:OFFSet:STATE</b>	OFF ON		DC offset permitting a DC voltage to be superimposed at the generator → Hardly any DC voltage at the output → DC voltage can be set with the next command. <b>Note:</b> <i>This setting cannot be made in the analog generator when a low-distortion generator is used.</i>	2.5.4.1.1 <b>GEN panel</b> DC Offset → OFF → ON
<b>SOURCE:VOLTage[:LEVel AMPLitude]:OFFSet</b>	<n> -5 V to 5 V -10 V to 10 V -1FS to 1FS	V FS	DC amplitude Analog instrument (OUTP:TYPE UNB) Analog instrument (OUTP:TYPE BAL) Digital instrument	2.5.4.1.1 <b>GEN panel</b> DC OFFSET
<b>SOURCE:SINusoid:DITHer:STATE</b>	ON OFF		→ Noise superimposed onto the signal. → Noise superimposition off For digital instrument only With option UPL-B29 (Digital Audio 96 kHz) not allowed in High Rate-Mode (CONF:DAI HRM), allowed in Base Rate-Mode (CONF:DAI BRM)	2.5.4.1.1 <b>GEN panel</b> Dither → ON → OFF
<b>SOURCE:SINusoid:DITHer</b>	<nu> 0 to 1 FS	FS	Noise amplitude	2.5.4.1.1 <b>GEN panel</b> Dither

Command	Parameter	Basic unit	Meaning	Section
<b>SOURCE:RANDOM:PDF</b>	GAUSSIAN TRIANGLE RECTANGLE		→ Noise distribution, Gaussian → Noise distribution, triangular → Noise distribution, equivalent	2.5.4.1.1 <b>GEN panel</b> PDF → GAUSS → TRIANGLE → RECTANGLE
<b>SOURCE:LOWDistortion</b>	ON OFF		→ Useful signal generated by LDG Only available with ANALOG generator and option UPL-B1 (Low Distortion Generator) → Both sines generated by function generator.	2.5.4.1 2.5.4.7 <b>GEN panel</b> Low Dist → ON → OFF
<b>SOURCE:SWEep ...</b>			For sweep commands see 3.10.1.4 Generator Sweeps	2.5.4.7 <b>GEN panel</b>
<b>SOURCE:FREQUENCY[1]:CW FIXed]</b>	<nu> ANALOG gen: 240 Hz to 21,75 kHz DIGITAL gen: 240 Hz to $f_{max}$ $f_{max}$ see 2.5.1	Hz	Useful frequency Can be used as sweep parameter	2.5.4.7 <b>GEN panel</b> UPPER FREQ
<b>SOURCE:FREQUENCY2]:CW FIXed]</b>	<nu> 30 Hz to $f_{max} / 8$ $f_{max}$ see 2.5.1	Hz	Interfering frequency	2.5.4.7 <b>GEN panel</b> LOWER FREQ
<b>SOURCE:VOLTage:TOTAL]:LEVEL AMPLitude]</b>	<nu> Value range determined by instrument or function	V FS	Total amplitude Can be used as sweep parameter Is voltage-limited by SOUR:VOLT:LIM see 3.10.1.2 and 3.10.1.3In the analog instrument the lower limit SOUR:VOLT:RAT (for high rms voltage specifications) depends on the required total rms voltage (see "TOTAL VOLT").	2.5.4.7 <b>GEN panel</b> TOTAL VOLT

Command	Parameter	Basic unit	Meaning	Section
SOURCE:VOLTage:RATio	<n> 1 to 10		Ratio of interfering to useful signal	2.5.4.7 GEN panel VOLT LF:UF

## 3.10.1.5.6 DFD

Command	Parameter	Basic unit	Meaning	Section
<b>SOURCE:FUNCTION</b> [:SHAPE]	<b>DFD</b>		→ Double sine (difference frequency method)	2.5.4.8 <b>GEN panel</b> FUNCTION → DFD
<b>SOURCE:FREQUENCY:OFFSet:STATE</b>	<b>ON</b> <b>OFF</b>		→ Frequency offset 0.1 % → No frequency offset	2.5.4.1 <b>GEN panel</b> Frq. Offset → + 1000 PPM → OFF
<b>SOURCE:VOLTage[:LEVel AMPLitude]:OFFSet:STATE</b>	<b>OFF</b> <b>ON</b>		DC offset permitting a DC voltage to be superimposed at the generator output. → Hardly any DC voltage at the output → DC voltage can be set with the next command. <b>Note:</b> <i>This setting cannot be made in the analog generator when a low-distortion generator is used. With the offset switched on, the S/N ratio of the analog DFD signal is poorer by 30 dB .</i>	2.5.4.1 <b>GEN panel</b> DC Offset → OFF → ON
<b>SOURCE:FUNCTION:MODE</b>	<b>IEC268</b>  <b>IEC118</b>		→ Entry of center frequency (MEAN FREQ) and difference frequency (DIFF FREQ) to IEC 268 with commands SOURCE:FREQ:MEAN <nu> and SOURCE:FREQ:DIFF <nu> If a frequency sweep is selected (for the X or Z axis), the center frequency is swept. → Entry of upper DFD frequency (UPPER FREQ) and difference frequency (DIFF FREQ) to IEC 118 with commands SOURCE:FREQ <nu> and SOURCE:FREQ:DIFF <nu> If a frequency sweep is selected (for the X or Z axis), the UPPER FREQ is swept.	<b>2.5.4.1.1</b> <b>GEN panel</b> <b>Mode</b> → IEC 268 → IEC 118

Command	Parameter	Basic unit	Meaning	Section
<b>SOURCE:VOLTage[:LEVel AMPLitude]:OFFSet</b>	<n> -5 V to 5 V -10 V to 10 V -1FS to 1FS	V V FS	DC amplitude Analog instrument (OUTP:TYPE UNB) Analog instrument (OUTP:TYPE BAL) Digital instrument	2.5.4.1.1 <b>GEN panel</b> DC OFFSET
<b>SOURCE:SINusoid:DITHer:STATE</b>	ON OFF		→ Noise is superimposed on signal. → Noise superimposition off For digital instrument only. With option UPL-B29 (Digital Audio 96 kHz) not allowed in High Rate-Mode (CONF:DAI HRM), allowed in Base Rate-Mode (CONF:DAI BRM)	2.5.4.1.1 <b>GEN panel</b> Dither → ON → OFF
<b>SOURCE:SINusoid:DITHer</b>	<nu> 0 to 1 FS	FS	Noise amplitude	2.5.4.1.1 <b>GEN panel</b> Dither
<b>SOURCE:RANDom:PDF</b>	GAUSSian TRIangle RECTangle		→ Noise distribution, Gaussian → Noise distribution, triangular → Noise distribution, uniform	2.5.4.1.1 <b>GEN panel</b> PDF → GAUSS → TRIANGLE → RECTANGLE
<b>SOURCE:LOWDistortion</b>	ON OFF		→ 1st sine generated by LDG Only available with ANALOG generator and option UPL-B1 (Low Distortion Generator)→ Both sines generated by function generator	2.5.4.1 2.5.4.8 <b>GEN panel</b> Low Dist → ON → OFF
<b>SOURCE:SWEep ...</b>			For sweep commands see 3.10.1.4 Generator Sweeps	
<b>SOURCE:FREQUENCY:MEAN</b>	<nu> Value range determined by instrument or function	Hz	Center frequency Can be used as sweep parameter	2.5.4.8 <b>GEN panel</b> MEAN FREQ



Command	Parameter	Basic unit	Meaning	Section
<b>SOURCE:FREQUENCY</b> : [1] [:CW FIXed]	<nu> Value range determined by instrument or function		Entry of upper DFD frequency with SOURCE:FUNCTION:MODE IEC 118 selected.	2.5.4.8 <b>GEN-panel</b> UPPER FREQ
<b>SOURCE:FREQUENCY</b> : <i>DIFFerence</i>	<nu> Value range determined by instrument or function	Hz	Difference frequency	2.5.4.8 <b>GEN panel</b> DIFF FREQ
<b>SOURCE:VOLTage</b> : <i>TOTAL</i> [:LEVEL AMPLitude]	<nu> Value range determined by instrument or function	V FS	Total amplitude Is voltage-limited by SOURCE:VOLT:LIM see 3.10.1.2 and 3.10.1.3	2.5.4.8 <b>GEN panel</b> TOTAL VOLT

## 3.10.1.5.7 RANDOM

Command	Parameter	Basic unit	Meaning	Section
<b>SOURce:FUNCTION</b> [:SHAPE]	RANDom		→ Noise	2.5.4.9 <b>GEN panel</b> FUNCTION → RANDOM
<b>SOURce:VOL TAge[:LEVel AMPLitude]:OFFSet:STATE</b>	OFF ON		DC offset permitting a DC voltage to be superimposed at the generator output. → Hardly any DC voltage at the output DC voltage can be set with the next command.  <b>Note:</b> <i>This setting cannot be made in the analog generator when a low-distortion generator is used.</i>	2.5.4.1.1 <b>GEN panel</b> DC Offset → OFF → ON
<b>SOURce:VOL TAge[:LEVel AMPLitude]:OFFSet</b>	<n> -5 V to 5 V -10 V to 10 V -1FS to 1FS	V FS	DC amplitude  Analog instrument (OUTP:TYPE UNB) Analog instrument (OUTP:TYPE BAL) Digital instrument	2.5.4.1.1 <b>GEN panel</b> DC OFFSET
<b>SOURce:RANDOM:DOMain</b>	<b>FREQuency</b> <b>TIME</b>		→ Frequency domain → Time domain	2.5.4.9 <b>GEN panel</b> Domain → FREQ → TIME
<b>SOURce:VOLTage:TOTal[:LEVel AMPLitude]</b>	<nu> 0 to 12 V 0 to 24 V 0 to 1 FS	V FS	Noise peak amplitude Analog instrument (OUTP:TYPE UNB) Analog instrument (OUTP:TYPE BAL) Digital instrument Is voltage-limited by SOUR:VOLT:LIM see 3.10.1.2 and 3.10.1.3	2.5.4.9 <b>GEN panel</b> VOLT PEAK
<b>SOURce:VOLTage:TOTal:RMS</b>	<nu>	V FS	Noise RMS amplitude Analog-Instrument Digital-Instrument	2.5.4.9 <b>GEN panel</b> VOLT RMS

## Further commands for frequency domain only (SOUR:RAND:DOM FREQ):

Command	Parameter	Basic unit	Meaning	Section
<b>SOUR</b> ce: <b>RANDom:SPACing:MODE</b>	<b>ATrack</b> <i>USERdefined</i>		→ Analyzer frequency spacing synchronous → Frequency spacing acc. to user entry	2.5.4.9 <b>GEN panel</b> Spacing → ANLR TRACK → USER DEF
<b>SOUR</b> ce: <b>RANDom:SPACing:FREQuency</b>	<nu> Value range determined by instrument or function	Hz	Entry of frequency spacing	2.5.4.9 <b>GEN panel</b> Spacing
<b>SOUR</b> ce: <b>RANDom:SHAPE</b>	<b>WHITE</b> <b>PINK</b> <b>TOCTave</b> <b>ARBITrary</b>		→ White noise → Pink noise → 1/3-octave noise → File-defined noise	2.5.4.9 <b>GEN panel</b> Equalizati → WHITE → PINK → THIRD OCT → FILE
<b>SOUR</b> ce: <b>RANDom:FREQuency:LOWer</b> <b>SOUR</b> ce: <b>RANDom:FREQuency:UPPer</b>	<nu> Value range determined by instrument or function	Hz	Lower/upper frequency limit for white and pink noise	2.5.4.9 <b>GEN panel</b> Lower Freq Upper Freq
<b>SOUR</b> ce: <b>FREQuency:MEAN</b>	<nu> Value range determined by instrument or function	Hz	Center frequency for 1/3-octave noise	2.5.4.9 <b>GEN panel</b> MEAM FREQ

Command	Parameter	Basic unit	Meaning	Section
<b>MMEMory:LOAD:LIST</b>	<b>ARbitrary, 'filename'</b> Query: MMEM:LOAD:LIST? ARB <b>RANDom, 'filename'</b> Query: MMEM:LOAD:LIST? RAND		File with data for file-defined noise. ARbitrary and RANDOM are synonyms.	2.5.4.9 <b>GEN panel</b> Shape File
<b>SOURce:AM:MODE</b>	<b>OFF</b> <b>SINusoid</b> <b>BURSt</b>		Selection of the type of modulation → The amplitude-modulation is switched off, the generator signal is not modulated. → The generator signal is amplitude-modulated from 0% to 100% in the form of a sinewave. → The generator signal is switched on and off periodically.	2.5.4.9 <b>GEN-Panel</b> Ampl Var → OFF → SINE → BURST
<b>SOURce:FREQUENCY:AM</b>	<b>&lt;nu&gt;</b> 1 $\mu$ Hz to fmax fmax depending on the generator	Hz	Setting of the modulation frequency Available only with SINE modulation (SOUR:AM:MODE SIN)	2.5.4.9 <b>GEN-Panel</b> Mod Freq
<b>SOURce:VOL TAge:AM</b>	<b>&lt;nu&gt;</b> -100% to 0%	PCT	Setting of the modulation deviation in % Available only with SINE modulation (SOUR:AM:MODE SIN)	2.5.4.9 <b>GEN-Panel</b> Variation
<b>SOURce:ONTime</b>	<b>&lt;nu&gt;</b> tmin to tmax Analog generator: tmin= 20.83 $\mu$ s Digital generator: tmin= 1 / sample frequency tmax: 60 s – tmin	s	Entry of the burst duration (time the sine is switched on) Available only with BURST modulation (SOUR:AM:MODE BURS)	2.5.4.9 <b>GEN-Panel</b> ON TIME

Command	Parameter	Basic unit	Meaning	Section
<b>SOURCE:INTERVAL</b>	<hu> set burst duration ... 60 s	s	Entry of the burst interval length (burst period), i.e., the sum of burst duration and break time  Available only with BURST modulation (SOUR:AM:MODE BURS)	2.5.4.9 <b>GEN-Panel</b> INTERVAL

**Further commands for time domain only (SOUR:RAND:DOM TIME):**

Command	Parameter	Basic unit	Meaning	Section
<b>SOURCE:RANDom:PDF</b>	<b>GAUSSian</b> <b>TRIangle</b> <b>RECTangle</b>		→ Noise distribution, Gaussian → Noise distribution, triangular → Noise distribution, uniform	2.5.4.9 <b>GEN panel</b> PDF → GAUSS → TRIANGLE → RECTANGLE

## 3.10.1.5.8 ARBITRARY

Command	Parameter	Basic unit	Meaning	Section
<b>SOURCE:FUNCTION</b> [:SHAPE]	USER		→ User-defined waveforms	2.5.4.10 <b>GEN panel</b> FUNCTION → ARBITRARY
<b>SOURCE:VOLTage[:LEVel AMPLitude]:OFFSet:STATE</b>	OFF ON		DC offset permitting a DC voltage to be superimposed at the generator output. → Hardly any DC voltage at the output → DC voltage can be set with the next command. <b>Note:</b> <i>This setting cannot be made in the analog generator when a low-distortion generator is used.</i>	2.5.4.1.1 <b>GEN panel</b> DC Offset → OFF → ON
<b>SOURCE:VOLTage[:LEVel AMPLitude]:OFFSet</b>	<n> -5 V to 5 V -10 V to 10 V -1FS to 1FS	V FS	DC amplitude Analog instrument (OUTP:TYPE UNB) Analog instrument (OUTP:TYPE BAL) Digital instrument	2.5.4.1.1 <b>GEN panel</b> DC Offset
<b>MMEMory:LOAD:LIST</b>	ARBITrary, 'filename' Query: MMEM:LOAD:LIST? ARB		File with data for waveform	2.5.4.10 <b>GEN panel</b> Filename

Command	Parameter	Basic unit	Meaning	Section
<b>SOURCE:VOLTage:TOTal[:LEVEL AMPLitude]</b>	<b>&lt;nu&gt;</b> <b>Analog Instrument:</b> Output = UNBAL: 0 to 14,142 V (OUTPUT = BAL: 0 to 16,971 V <b>Digital Instrument:</b> Src Mode = AUDIO DATA: 0 to 1 FS Src Mode = JITTER ONLY: 0 UI to 2,5 UI Src Mode = PHASE: 0 to 1 FS Src Mode = COMMON ONLY: 0 V to 10 V	V FS	Peak amplitude of signal  SOUR:VOLT:TOT and SOUR:VOLT:TOT:RMS are coupled via the crest factor (which is constant for a specific signal). A change of SOUR:VOLT:TOT therefore immediately affects the figure for SOUR:VOLT:TOT:RMS. If the crest factor is changed, SOUR:VOLT:TOT will remain unchanged.  Is voltage-limited by SOUR:VOLT:LIM see 3.10.1.2 and 3.10.1.3	2.5.4.10 <b>GEN panel</b> VOLT PEAK
<b>SOURCE:VOLTage:TOTal:RMS</b>	<b>&lt;nu&gt;</b> 0 V to 20 V	V FS	RMS signal amplitude for Analog generator Only available with ANALOG generator in format AWD and TTF SOUR:VOLT:TOT and SOUR:VOLT:TOT:RMS are coupled via the crest factor (which is constant for a specific noise signal). A change of SOUR:VOLT:TOT:RMS therefore affects the SOUR:VOLT:TOT value.	2.5.4.10 <b>GEN panel</b> VOLT RMS
<b>SOURCE:AM:MODE</b>	<b>OFF</b> <b>SINusoid</b> <b>BURSt</b>		Selection of the type of modulation → The amplitude modulation is switched off, the generator signal is not modulated. → The generator signal is amplitude-modulated from 0% to -100% → The generator signal is switched on and off periodically. .	2.5.4.10 <b>GEN-Panel</b> Ampl Var → OFF → SINE → BURST
<b>SOURCE:FREQUENCY:AM</b>	<b>&lt;nu&gt;</b> 1 $\mu$ Hz to $f_{max}$ $f_{max}$ depending on the generator	Hz	Setting of the modulation frequency Available only with SINE modulation (SOUR:AM:MODE SIN)	2.5.4.10 <b>GEN-Panel</b> Mod Freq

Command	Parameter	Basic unit	Meaning	Section
<b>SOURCE:VOLTage:AM</b>	<nu> -100% ... 0%	PCT	Setting of the modulation deviation in % Available only with SINE modulation (SOUR:AM:MODE SIN)	2.5.4.10 <b>GEN-Panel</b> Variation
<b>SOURCE:ONTime</b>	<nu> tmin to tmax Analog generator: tmin= 20.83 $\mu$ s Digital generator: tmin= 1 / sample frequency tmax: 60 s – tmin	s	Entry of the burst duration (time the sine is switched on) Available only with BURST modulation (SOUR:AM:MODE BURS)	2.5.4.10 <b>GEN-Panel</b> ON TIME
<b>SOURCE:INTERval</b>	<nu> set burst duration ... 60 s	s	Entry of the burst interval length (burst period), i.e., the sum of burst duration and break time Available only with BURST modulation (SOUR:AM:MODE BURS)	2.5.4.10 <b>GEN-Panel</b> INTERVAL



## 3.10.1.5.9 POLARITY

Command	Parameter	Basic unit	Meaning	Section
<b>SOURCE:FUNCTION</b> [:SHAPE]	<b>POLarity</b>		→ Polarity test signal	2.5.4.11 <b>GEN panel</b> FUNCTION → POLARITY
<b>SOURCE:VOLTage[:LEVel AMPLitude]:OFFSet:STATE</b>  OFF ON			DC offset permitting a DC voltage to be superimposed at the generator output. → Hardly any DC voltage at the output → DC voltage can be set with the next command. <b>Note:</b> <i>This setting cannot be made in the analog generator when a low-distortion generator is used.</i>	2.5.4.1.1 <b>GEN panel</b> DC Offset → OFF → ON
<b>SOURCE:VOLTage[:LEVel AMPLitude]:OFFSet</b>	<b>&lt;n&gt;</b> -5 V to 5 V -10 V to 10 V -1FS to 1FS	V FS	DC amplitude Analog instrument (OUTP:TYPE UNB) Analog instrument (OUTP:TYPE BAL) Digital instrument	2.5.4.1.1 <b>GEN panel</b> DC Offset
<b>SOURCE:VOLTage[:LEVel AMPLitude]</b>	<b>&lt;nu&gt;</b> 0 to 12 V 0 to 20 V 0 to 1 FS	V FS	Pulse amplitude Analog instrument (OUTP:TYPE UNB) Analog instrument (OUTP:TYPE BAL) Digital instrument  Is voltage-limited by SOUR:VOLT:LIM see 3.10.1.2 and 3.10.1.3	2.5.4.11 <b>GEN panel</b> VOLTAGE

## 3.10.1.5.10 FSK (Frequency shift keying)

Command	Parameter	Meaning	Section
<b>SOURCE:FUNCTION[:SHAPE]</b>	FSK	Frequency shift keying; generates a sequence of two different sinewave frequencies each being output for 9 ms (baud rate 110). The data coded in this way can only be defined from option UPL-33 or UPL-B10 using command SOURCE:O33 'O33'. Frequency #1: 1850 Hz, logic 0 Frequency #2: 1650 Hz, logic 1	<b>2.5.4.12 GEN panel FUNCTION</b> → FSK
<b>SOURCE:VOLTage[:LEVel AMPLitude]:OFFSet:STATE</b>	ON OFF	DC offset allows a DC voltage to be superimposed onto the generator output. → Almost no DC voltage at the output → The DC component can be set with the following command. <b>Note:</b> <i>This setting is not possible in the analog generator when the low-distortion generator is used.</i>	<b>2.5.4.12 GEN panel DC Offset</b> → OFF → ON
<b>SOURCE:VOLTage[:LEVel AMPLitude]:OFFSet</b>	<nu> -5 V to 5 V -10 V to 10 V -1FS to 1FS	Amplitude of DC component Analog instrument (OUTP:TYPE UNB) Analog instrument (OUTP:TYPE BAL) Digital instrument	<b>2.5.4.12 GEN panel DC Offset</b>
<b>SOURCE:VOLTage</b>	<nu> 0 to 11.29 V 0 FS to 1 FS	Level for both FSK frequencies	<b>2.5.4.12 GEN panel Volt No 1</b>
<b>SOURCE:O33</b>	'O33 ID code	Sends the code for line measurements. The data coded in this way can only be sent from option UPL-B33 or UPL-B10 (universal sequence controller).	<b>No manual operation</b>

## 3.10.1.5.11 STEREO SINE

Command	Parameter	Meaning	Section
<b>SOURCE:FUNCTION[:SHAPE]</b>	STEREO	→ Sine with different signals for the left and right channel. Only available with DIGITAL generator and option UPL-B6 (Extended Analysis Function)	<b>2.5.4.13</b> <b>GEN-Panel</b> FUNCTION → STEREO SINE
<b>SOURCE:FREQUENCY:OFFSet:STATE</b>	ON OFF	→ Frequency offset 0.1 % → No frequency offset	<b>2.5.4.13</b> <b>GEN-Panel</b> Frg. Offset, → +1000 ppm → OFF
<b>SOURCE:VOLTage[:LEVel AMPLitude]:OFFSet:STATE</b>	OFF ON	DC offset permitting a DC voltage to be superimposed to the generator output. → Hardly any DC voltage at the output → DC voltage can be set with the next command. <b>Note:</b> <i>This setting cannot be made in the ANALOG generator when a low-distortion generator is used.</i>	<b>2.5.4.13</b> <b>GEN-Panel</b> DC Offset → OFF → ON
<b>SOURCE:VOLTage[:LEVel AMPLitude]:OFFSet</b>	<nu> -1 FS to 1 FS	DC amplitude	<b>2.5.4.13</b> <b>GEN-Panel</b> DC Offset
<b>SOURCE:SINusoid:DITHer:STATE</b>	ON OFF	→ Noise superimposed on signal → Noise superimposition off	<b>2.5.4.13</b> <b>GEN-Panel</b> Dither → ON → OFF
<b>SOURCE:SINusoid:DITHer</b>	<nu> 0 to 1 FS	Noise amplitude	<b>2.5.4.13</b> <b>GEN-Panel</b> Dither

Command	Parameter	Meaning	Section
<b>SOURCE:RANDOM:PDF</b>	GAUSSian TRIangle RECTangle	→ Noise distribution, Gaussian → Noise distribution, triangular → Noise distribution, uniform	<b>2.5.4.13</b> <b>GEN-Panel</b> PDF → GAUSS → TRIANGLE → RECTANGLE
<b>SOURCE:VOLTage:EQUALize:STATE</b>	ON OFF	→ Sine signal equalized → Sine signal not dependent on frequency	<b>2.5.4.13</b> <b>GEN-Panel</b> Equalizer → ON → OFF
<b>MEMORY:LOAD:LIST</b>	<b>EQUALize, 'filename'</b> Query: MMEM:LOAD:LIST? EQU	File containing equalizer data if SOURCE:VOLT:EQU:STAT ON	<b>2.5.4.13</b> <b>GEN-Panel</b> Equal.File
<b>SOURCE:FREQUENCY:SELECT</b>	<b>FQPH</b> <b>FQFQ</b>	Determines the type of frequency entry in the left and right channel. → Left (CH1) and right channel (CH2) have the same frequency but a selectable phase with a fixed delay. → The frequency of the left (CH1) and right channel (CH2) can be entered independently of each other.	<b>2.5.4.13</b> <b>GEN-Panel</b> Freq Mode FREQ&PHASE FREQ CH1&2
<b>SOURCE:VOLTage:SELECT</b>	<b>VLRT</b> <b>VLVL</b>	Determines the type of level entry in the left and right channel. → The levels of the left (CH1) and right channel (CH2) have a fixed offset. The offset remains constant during level sweep. → The level of the left (CH1) and right channel (CH2) can be entered independently of each other.	<b>2.5.4.13</b> <b>GEN-Panel</b> Volt Mode VOLT&RATIO VOLT CH1&2
<b>SOURCE:SWEep ...</b>		For sweep commands see 3.10.1.4 Generator Sweeps	

Command	Parameter	Hz	Meaning	Section
<b>SOURCE:FREQUENCY</b> [:CW FIXed]	<nu> Value range determined by instrument or function	Hz	If SOUR:FREQ:SEL FQPH selected: Entry of common sine frequency for both channels. Can be used as sweep parameter. If SOUR:FREQ:SEL FQFQ selected: Entry of sine frequency of left channel. Can be used as sweep parameter.	2.5.4.13 <b>GEN-Panel</b> FREQUENCY oder Freq Ch1
<b>SOURCE:FREQUENCY:CH2Stereo</b>	<nu> Value range determined by instrument or function		Only available if SOUR:FREQ:SEL FQFQ: Entry of sine frequency of right channel. Remains constant during sweep.	2.5.4.13 <b>GEN-Panel</b> Freq Ch2
<b>SOURCE:PHASE</b>	<nu> 0 ° to 360 °	DEG	Only available with SOUR:FREQ:SEL FQPH: Entry of phase delay between right and left channel with the left channel (CH1) as reference channel. During the sweep this phase remains constant and cannot be swept.	2.5.4.13 <b>GEN-Panel</b> Phas Ch2:1
<b>SOURCE:VOLTage[:LEVel AMPLitude]</b>	<nu> 0 to 1 FS	FS	Entry of sine amplitude of left channel; may be used as sweep parameter. The sine amplitude of right channel remains constant during sweep. Is voltage-limited by SOUR:VOLT:LIM see 3.10.1.2 and 3.10.1.3	2.5.4.13 <b>GEN-Panel</b> VOLT Ch1
<b>SOURCE:VOLTage:CH2Stereo</b>	<nu> 0 to 1 FS	FS	Only available with SOURce:VOLTage:SELECT VLVL: Entry of sine amplitude of right channel. Remains constant during sweep. Is voltage-limited by SOUR:VOLT:LIM see 3.10.1.2 and 3.10.1.3	2.5.4.13 <b>GEN-Panel</b> VOLT Ch2
<b>SOURCE:VOLTage:RATio</b>	<n> 0 to 100000		Only available with SOUR:VOLT:SEL VLRT: Entry of level offset between channel 2 (right channel) and channel 1 (left channel) as numeric value. The level of the right channel is reset upon each command SOUR:VOLT:RATio <n> or SOURce:VOLTage <nu> and limited to 1.0 FS or 'Max Volt'.	2.5.4.13 <b>GEN-Panel</b> Volt Ch2:1

## 3.10.1.5.12 MODULATION (FM or AM signal)

Command	Parameter	Meaning	Section
<b>SOURCE:FUNCTION</b>	FM	Setting a modulated sinewave signal. Either FM or AM can be used.	2.5.4.14 <b>GEN-Panel</b> FUNCTION → FM
<b>SOURCE:VOLTage[:LEVel AMPLitude]:OFFSet:STATE</b>	OFF ON	DC offset permitting a DC voltage to be superimposed to the generator output. → Hardly any DC voltage at the output → DC voltage can be set with the next command. <b>Note:</b> <i>This setting cannot be made in the ANALOG generator when a low-distortion generator is used.</i>	2.5.4.14 <b>GEN-Panel</b> DC Offset → OFF → ON
<b>SOURCE:VOLTage[:LEVel AMPLitude]:OFFSet</b>	<nu> -5 V to 5 V -10 V to 10 V -1 FS to 1 FS	DC amplitude  Analog instrument (OUTP:TYPE UNB) Analog instrument (OUTP:TYPE BAL) Digital instrument	2.5.4.14 <b>GEN-Panel</b> DC OFFSET
<b>SOURCE:FUNCTION:MODE</b>	FM AM	Determines the type of modulation. → Frequency modulation; output of a frequency-modulated sinewave signal. → Amplitude modulation; output of amplitude-modulated sinewave signal.	2.5.4.14 <b>GEN-Panel</b> Mode → FM → AM
<b>SOURCE:FREQUENCY[:CW FIXed]</b>	<nu> Value range determined by instrument and sample frequency	Setting the modulation frequency	2.5.4.14 <b>GEN-Panel</b> Mod Freq oder Freq Ch1

Command	Parameter	Meaning	Section
<b>SOURCE:VOLTage[:LEVel AMPLitude]</b>	<nu> 0 to 100 %	Modulation deviation / depth  With SOUR:FUNC:MODE FM: Setting the deviation in %. With SOUR:FUNC:MODE AM: Setting of modulation depth in %	2.5.4.14 <b>GEN-Panel</b> Bei FM: Deviation Bei AM: Mod Depth
<b>SOURCE:FREQUENCY2[:CW FIXed]</b>	<nu> Value range determined by instrument and sample frequency	Setting the carrier frequency	2.5.4.14 <b>GEN-Panel</b> Carr Freq
<b>SOURCE:VOLTage2</b>	<nu> 0 to 5 V 0 to 6V 0 to 0.5 FS	Setting the carrier amplitude  Analog instrument (OUTP:TYPE UNB) Analog instrument (OUTP:TYPE BAL) Digital instrument	2.5.4.14 <b>GEN-Panel</b> Carr Volt

### 3.10.1.5.13 DC voltage

Command	Parameter	Meaning	Section
<b>SOURCE:FUNCTION</b>	DC	DC voltage	2.5.4.15 <b>GEN-Panel</b> FUNCTION → DC
<b>SOURCE:SWEep ...</b>		For sweep commands see 3.10.1.4 Generator Sweeps	
<b>SOURCE:VOLTage:TOTal[:LEVel AMPLitude]</b>	<nu> - 5 V to 5 V -1 FS to 1 FS	Entry of DC amplitude; may be used as sweep parameter. Is voltage-limited by SOUR:VOLT:LIM see 3.10.1.2 and 3.10.1.3	2.5.4.15 <b>GEN-Panel</b> VOLTAGE

## 3.10.1.5.14 Coded Audio (Coded Audio Signals)

Command	Parameter	Basic unit	Meaning	Section
<b>SOURCE:FUNCTION[:SHAPE]</b>	<b>CODedaud</b>		<p>→ Output of digitally coded audio data to IEC 61937.</p> <p>Available only</p> <ul style="list-style-type: none"> <li>• if the UPL-B23 (Coded Audio Signal Generation) is installed in DIGITAL generator (INST D48) in Meas Mode AUDIO DATA (SENSE:DIGital:FEED ADATa) at a sampling frequency of 48 kHz (OUTP:SAMP:MODE F48)</li> </ul>	<b>2.5.4.16 GEN Panel FUNCTION</b> → CODED AUDIO
<b>SOURCE:CODedaudio:FORMAT</b>	<b>AC3</b>		<p>Coding format AC-3 (Dolby Digital)</p> <p>Other formats are in preparation.</p>	<b>2.5.4.16 GEN Panel Format</b> → AC-3
<b>SOURCE:CODedaudio:CHANNEL</b>	<b>CH2</b> <b>CH6</b>  <b>CHL</b> <b>CHC</b> <b>CHR</b> <b>CHLS</b> <b>CHRS</b> <b>CHLF</b>		<p>Selection of channels producing sound.</p> <p>→ Stereo mode at 192 kb/s. Frequency and level variation or sweep are possible.</p> <p>→ Multichannel sound with all channels at 448 kb/s. Frequency and level variation or sweep possible.</p> <p>Single channels at 448 kb/s. Limited frequency selection 41.7 Hz, 994.8 Hz or 15 kHz (see next command) at a fixed level of -20 dB. Coding of samples at 16 bit.</p> <p>→ Front left → Front center → Front right → Rear left → Rear right → Low frequency enhancement</p>	<b>2.5.4.16 GEN Panel Chan Mode</b> → 2/0 192kb/s → 5.1 448kb/s → L 448kb/s → C 448kb/s → R 448kb/s → LS 448kb/s → RS 448kb/s → LFE 448kb/s



Command	Parameter	Basic unit	Meaning	Section
<b>SOURCE:CODEaudio:FREQUENCY</b>	F042 F997 F15K		<p>Fixed frequency selection for crosstalk measurements and linearity (level) sweeps.</p> <p>→ exactly 41.7 Hz → exactly 994.8 Hz → exactly 15000.0 Hz</p> <p>Only available in</p> <ul style="list-style-type: none"> <li>single channel modes (SOURCE:COD:CHAN CHL CHC CHR CHLS CHRS CHLF) or with level variation (SOURCE:VOLT:MODE FIX) selected</li> </ul>	<b>2.5.4.16 GEN Panel</b> Frequency → 42 Hz → 997 Hz → 15 kHz
<b>SOURCE:SWEEP ...</b>			For sweep commands see 3.10.1.4 Generator Sweeps	<b>2.5.4.16 GEN Panel</b> SWEEP CTRL
<b>SOURCE:FREQUENCY:MODE</b>	FIX		Frequency can be varied. The level is at -20 dB. 2.5.4.16	<b>2.5.4.16 GEN Panel</b> Vari Mode → FREQUENCY
<b>SOURCE:FREQUENCY</b>	<new> 5.21 Hz to 20 kHz at a sampling rate of 48 kHz	Hz	<p>Entry of sine frequency (can be swept).</p> <p>The frequency step width depends on the number of WAV files in the C:\UPLAC3\48000\... directory and the frame length per WAV file: Frequency range: 5 Hz to 1 kHz 1 kHz to 3 kHz 3 kHz to 20 kHz Resolution 5.21 Hz 10.42 Hz 31.25 Hz Number of frames: max. 6 max. 3 max. 1</p> <p>Frequency values outside this pattern are adapted to the next possible value. Only available in the multichannel modes 2/0 or 5.1 (SOURCE:COD:CHAN CH2 CH6) with frequency variation SOURCE:FREQ:MODE FIX selected.</p>	<b>2.5.4.16 GEN Panel</b> FREQUENCY

Command	Parameter	Basic unit	Meaning	Section
<b>SOURCE:VOLTage:MODE</b>	FIX		The level can be varied in 24 steps of -5 dBFS between 0 dBFS and -120 dBFS; one of three fixed settings can be selected as frequency (SOURCE:FREQ F042 F997 F15K). This setting allows sweep of the sine amplitude (next command). Only available in the multichannel modes 2/0 or 5.1 (SOURCE:COD:CHAN CH2 CH6)	<b>2.5.4.16</b> <b>GEN Panel</b> Vari Mode → VOLTAGE
<b>SOURCE:VOLTage:TOTal[:LEVel AMPLitude]</b>	<new> 1 $\mu$ FS to 1 FS or -120 dBFS to 0 dBFS	FS	Entry of sine amplitude (can be swept) Level can be varied in 24 steps of -5 dBFS between 0 dBFS and -120 dBFS. Level values outside this pattern are adapted to the next possible value. Only available in the multichannel modes 2/0 or 5.1 (SOURCE:COD:CHAN CH2 CH6) with level variation SOURCE:VOLTage:MODE FIX selected.	<b>2.5.4.16</b> <b>GEN Panel</b> TOTAL VOLT



### 3.10.2 IEC/IEEE-Bus Commands for Analyzers

#### 3.10.2.1 Selection of Analyzer

Command	Parameter	Basic unit	Meaning	Section
<b>INSTRument2[:SELect]</b> equivalent to <b>INSTRument2:NSELect</b>	A22 A110 D48  1 2 4		→ Analog analyzer, 22 kHz → Analog analyzer, 110 kHz → Digital analyzer, 48 kHz  → Analog analyzer, 22 kHz → Analog analyzer, 110 kHz → Digital analyzer, 48 kHz	2.6.1 <b>ANLR panel</b> INSTRUMENT → ANLG 22 kHz → ANLG 110 kHz → DIGITAL

#### 3.10.2.2 Configuration of Analog Analyzers

Command	Parameter	Basic unit	Meaning	Section
<b>INPut[:FILTer[:LPASs]:FREQuency</b>	<nu> Query only 2 Hz   10 Hz	Hz	Lower limit frequency for analyzer instruments A22 and D48.	2.6.2 <b>ANLR panel</b> Min Freq
<b>SENSe[:POWer:REFerence:RESistance</b>	<nu> 1 mΩ to 100 kΩ	Ohm	Reference resistance for power units	2.4 (RREF 2.6.2 <b>ANLR panel</b> Ref Imped

Command	Parameter	Basic unit	Meaning	Section
<b>INP</b> ut[]: <b>SE</b> lect	<b>CH1</b> <b>CH2</b> <b>CH1And2</b> <b>CH1Is2</b> <b>CH2Is1</b>		<ul style="list-style-type: none"> <li>→ Only channel 1 active</li> <li>→ Only channel 2 active</li> <li>→ Channel 1 and 2 active, settings may be different</li> <li>→ Channel 1 and 2 active, identical settings</li> <li>Data of channel 1 adopted for channel 2.</li> <li>→ Channel 1 and 2 active, identical settings</li> <li>Data of channel 2 adopted for channel 1.</li> </ul>	2.6.2 <b>ANLR panel</b> CHANNEL(s) → 1 → 2 → 1 & 2 → 1 ≡ 2 → 2 ≡ 1
<b>INP</b> ut[1 2]: <b>COU</b> pling	<b>AC</b>  <b>DC</b>		<p>Selection of coupling of analyzer input circuit for channels 1 and 2: available in the two analog analyzer instruments only (INST2 A22   100).</p> <p>→ AC coupling A DC offset of the DUT will not be transmitted and does not therefore affect the DUT.</p> <p><b>Note:</b> A procedure similar to AC coupling can be selected in the digital analyzer for specific measurement functions. Selection is made with menu item DC Suppress ON (SENS:FUNC:DCS ON).</p> <p>→ DC coupling: Test signals up to 0 Hz are picked up and considered in the results of RMS, RMS selective, Peak, Quasi-peak, DC, FFT and Waveform measurements.</p>	2.6.2 <b>ANLR panel</b> CH1 Coupl CH2 Coupl → AC → DC
<b>INP</b> ut[1 2]: <b>TY</b> PE	<b>BAL</b> anced <b>GEN1</b> <b>GEN2</b>		<ul style="list-style-type: none"> <li>→ Balanced input (XLR connector), see Fig. 2-1/11. For analog instruments only.</li> <li>→ Internal connection to generator channel 1. For analog instruments only.</li> <li>→ Internal connection to generator channel 2. For analog instruments only.</li> </ul>	2.6.2 <b>ANLR panel</b> Input → BAL XLR → GEN1 → GEN2 → GEN CROSSED
<b>INP</b> ut[1 2]: <b>IMP</b> edance	<b>R300</b> <b>R600</b> <b>R200K</b>		Input impedance for unbalanced input → 300 Ω → 600 Ω → 200 kΩ	2.6.2 <b>ANLR panel</b> Imped → 300 Ω → 600 Ω → 200 Ω

Command	Parameter	Basic unit	Meaning	Section
<b>INP</b> ut[1 2]: <b>LOW</b>	<b>FLOat</b> <b>GROund</b>		→ Outer conductor of unbalanced. input not connected to instrument ground (PE conductor). → Outer conductor of unbalanced. input connected to instrument ground (PE conductor)	2.6.2 <b>ANLR panel</b> Common → FLOAT → GROUND
<b>SENSe</b> [: <b>VOLTage:RANGe</b> [1 2]: <b>LOWer</b>	<b>&lt;nu&gt;</b> For value range see 2.6.2 Configuration of the Analog Analyzers	V	Sets a range containing the specified level value. No under range but higher ranges may be selected.	2.6.2 <b>ANLR panel</b> Range → LOWER
<b>SENSe</b> [: <b>VOLTage:RANGe</b> [1 2]: <b>AUTO</b>	<b>ON</b> <b>OFF</b>		→ Autoranging → The current range is accepted and retained as :UPPer. Corresponds to <b>SENSe</b> [: <b>VOLTage:RANGe</b> [1 2]: <b>UPPer</b> ]<current range>	2.6.22.6.2 <b>ANLR panel</b> Range → AUTO
<b>SENSe</b> [: <b>VOLTage:RANGe</b> [1 2]: <b>UPPer</b> ]	<b>&lt;nu&gt;</b> For value range see 2.6.2 Configuration of the Analog Analyzers	V	Sets a range containing the specified level value and holds it unconditionally.	2.6.2 <b>ANLR panel</b> Range → FIX

## 3.10.2.3 Configuration of Digital Analyzers

Command	Parameter	Basic unit	Meaning	Section
<b>SENSe:DIGital:FEED</b>	<b>ADATa</b> <b>JPHase</b> <b>CINPut</b>		Specifies the parameter measured in the analyzer: → Audio content → Demodulated jitter signal in the frequency range 0 to 100 kHz → Common-mode signal of digital inputs measured. Frequency range and measurement function same as with jitter.	2.6.3.1 <b>ANLR panel</b> Meas Mode → AUDIO DATA → JITTER/PHAS → COMMON/INP
<b>SENSe:DIGital:SYNC:REFERENCE</b>	<b>GCLock</b>  <b>PLLVari</b>  <b>PLL32</b> <b>PLL44</b> <b>PLL48</b>  <b>PLL88</b> <b>PLL96</b>		Indicates the signal to which the jitter measurement should be referenced. → The generator clock is the reference for the jitter measurement. This is only possible when the generator is also synchronized to the internal generator clock (menu item "Sync To GEN CLK" (SOUR:DIG:SYNC:SOUR GCL) in GENERATOR panel) → Reference signal is the sampling signal derived from the input signal via the internal synchronization PLL. Synchronization is made via the VCO with maximum lock-in range. The capture range is: • with option UPL-B2 (Digital Audio I/O) 27 kHz to 55 kHz • with option UPL-B29 in the Base Rate Mode 40 kHz to 55 kHz • with option UPL-B29 in the High Rate Mode 40 kHz to 106 kHz → Reference signal is the sampling signal derived from the ... → ... input signal via the internal synchronization PLL. Synchronization is ... → ... made via the fixed-frequency VCXO. → only with option UPL-B29 (Digital Audio 96 kHz) ... → ... in the High Rate Mode. Only with Meas Mode JITTER/PHASE (SENS:DIG:FEED:JPH) selected.	2.6.3 <b>ANLR-Panel</b> Related to → GEN CLK → VARI (PLL) → 32.0 (PLL) → 44.1 (PLL) → 48.0 (PLL) → 88.2 (PLL) → 96.0 (PLL)
<b>INPut:FILTEr[:LPASs]:FREQUENCY</b>	<n> Query only 10 Hz   20 Hz	Hz	Lower frequency limit of analyzer. For SENS:DIG:FEED ADAT only.	2.6.1 <b>ANLR panel</b> Min Freq

Command	Parameter	Basic unit	Meaning	Section
<b>INP</b> ut[]: <b>SElect</b>	<b>CH1</b> <b>CH2</b> <b>BOTH</b>		For SENS:DIG:FEED ADAT only → Only channel 1 active → Only channel 2 active → Channel 1 and 2 active, identical setting	2.6.2 2.6.3 <b>ANLR panel</b> CHANNEL(s) → 1 → 2 → BOTH
<b>INP</b> ut[1 2]: <b>TYPE</b>	<b>AESebu</b> <b>SPDif</b> <b>OPTical</b> <b>INTern</b>		→ AES/EBU interface, for connector see Fig. 2-1/17. → S/P DIFF interface, for connector see Fig. 2-1/17. → Optical interface, for connector see Fig. 2-1/17. → Internal interface for digital generator OPTical and INTern for SENS:DIG:FEED ADAT PHAS only.	2.6.3 <b>ANLR panel</b> Input → BAL (XLR) → UNBAL (XLR) → OPTICAL → INTERN
<b>SENSe:DIGital:SYNC:SOURCE</b>	<b>AINP</b> ut <b>RINP</b> ut		→ The receiver is clocked with the input signal (for SENS:DIG:FEED ADAT PHAS only). → The receiver is clocked with the signal at the reference input (for SENS:DIG:FEED ADAT JPH only).	2.6.3 <b>ANLR panel</b> Sync To → AUDIO IN → REF IN



Command	Parameter	Basic unit	Meaning	Section
<b>INP</b> ut[]: <b>SAMP</b> le: <b>FREQU</b> ency: <b>MODE</b>	<b>F32</b> <b>F44</b> <b>F48</b> <b>F88</b> <b>F96</b> <b>VALue</b> <b>AUTO</b> <b>CHSTatus</b>		Setting the signal clock rate. → Sampling frequency 32 kHz for digital instrument, only with option UPL-B2 (Digital Audio I/O) → Sampling frequency 44.1 kHz for digital instrument → Sampling frequency 48 kHz for digital instrument → Sample frequency 88.2 kHz (only with option UPL-B29 Digital Audio 96 kHz in High Rate Mode CONF:DAI HRM) → Sample frequency 96 kHz (only with option UPL-B29 Digital Audio 96 kHz in High Rate Mode CONF:DAI HRM) → Sampling frequency externally applied. For input values see next command. → Transfer of measured sample frequency. The sample rate is updated if the value varies by more than 0.01%. Smaller variations are ignored. → Transfer of the sample frequency specified in the channel status data. For SENS:DIG:FEED ADAT PHAS only.	2.6.3 <b>ANLR panel</b> Sample Frq → 32 kHz → 44.1 kHz → 48 kHz → 88.2 kHz → 96.0 kHz → VALUE: → AUTO → CHAN STATUS
<b>INP</b> ut[]: <b>SAMP</b> le: <b>FREQU</b> ency	<nu> 27 kHz to 55 kHz 40 kHz to 55 kHz 40 kHz to 106 kHz	Hz	Value of applied sampling frequency with option UPL-B2 (Digital Audio I/O) with option UPL-B29 im Base Rate Mode with option UPL-B29 im High Rate Mode for SENS:DIG:FEED ADAT PHAS only	2.6.3 <b>ANLR panel</b> Sample Frq → VALUE:
<b>INP</b> ut[]: <b>AUDI</b> obits	<n> For value range see 2.6.3 Configuration of the Digital Analyzer		Word length of audio samples to be analyzed in bits. For SENS:DIG:FEED ADAT PHAS only	2.6.3 <b>ANLR panel</b> Audio Bits

## 3.10.2.4 Starting the Analyzer, Ext. Sweep

Command	Parameter	Basic unit	Meaning	Section
<b>TRIGGER:SOURCE</b>	<b>IMMEDIATE</b> <b>TIMER</b> <b>CH1Freq CH2Freq</b> <b>CH1Level CH2Level</b> <b>CH1Trigger CH2Trigger</b> <b>TCHart</b>  <b>CH1Rapidfreq</b> <b>CH2Rapidfreq</b> <b>CH1Edgetrigger</b> <b>CH2Edgetrigger</b>		→ Continuous measurement mode without trigger condition → Storing measured values in the buffer at regular intervals. → Collection of measured values due to a variation in frequency found at the ANALYZER input, channel 1 or channel 2. → Collection of measured values due to a variation in level found at the ANALYZER input, channel 1 or channel 2. → Triggers a single measurement as soon as the level is within the range specified by ARM:VOLT:STAR and ARM:VOLT:STOP. → Measured values from the ongoing continuous measurement are entered into a timing diagram at the time interval selected by means of command TRIG:TIM <nu>. → External frequency sweep with fast frequency measurement in channel 1 and channel 2 → Edge-sensitive triggering; a measurement is triggered as soon as the level enters the interval between ARM:VOLT:START and ARM:VOLT:STOP for the first time.	2.6.4 <b>ANLR panel</b> START COND → AUTO → TIME → CH1Freq   CH2Freq → CH1Level   CH2Level → LEV TRG CH1   LEV TRG CH2 → TIME CHART → FRQ FST CH1 → FRQ FST CH2  → EDG TRG CH1 → EDG TRG CH2
<b>TRIGGER:DELAY</b>	<nu> 0 s to 10 s	s	Waiting time after the measurement (settling time for DUT).	2.6.4 <b>ANLR panel</b> Delay
<b>TRIGGER:TIMER</b>	<nu> 10 ms to 2000 s	s	Interval between recordings of measured values.	2.6.4 <b>ANLR panel</b> Timetick
<b>TRIGGER:COUNT</b>	<n> 2 to 1024		Number of measured values entered into the buffer.	2.6.4 <b>ANLR panel</b> Points
<b>ARM:LEVEL:MIN</b>	<nu> Analog instruments 10 $\mu$ V to 1000 V Digital instrument 1 $\mu$ FS to 1.0 FS	V FS	Minimum voltage required for triggering a measurement with external frequency sweep.	2.6.4 <b>ANLR panel</b> Min VOLT

Command	Parameter	Basic unit	Meaning	Section
<b>ARM:FREQUENCY:START</b> <b>ARM:FREQUENCY:STOP</b>	<nu> Value range determined by instrument or function	Hz	The input frequency must be within the start/stop frequency for triggering the measurement.	2.6.4 <b>ANLR panel</b> Start   Stop
<b>ARM:VOLTage:START</b> <b>ARM:VOLTage:STOP</b>	<nu> Analog instruments 10 $\mu$ V to 1000 V Digital instrument 1 $\mu$ FS to 1.0 FS	V FS	The input level must be within the start/stop voltage limits for triggering a measurement.	2.6.4 <b>ANLR panel</b> Start   Stop
<b>TRIGGER:FREQUENCY:VARIation</b>	<nu> LL to 50%	PTC	Minimum percentage by which the input frequency must vary for triggering a measurement. LL: The lower limit for the entry of variation is not less than 0.1% and is output such that not more than 1024 measured values are generated (depending on the spacing between start and stop values).	2.6.4 <b>ANLR panel</b> Variation
<b>TRIGGER:VOLTage:VARIation</b>	<nu> LL to 900% or LL to 20 dB	PTC	Minimum percentage or dB value by which the input voltage must vary for triggering a measurement. LL: The lower limit for the entry of variation is not less than 0.1% or 0.01 dB and is output such that not more than 1024 measured values are generated (depending on the spacing between start and stop values).	2.6.4 <b>ANLR panel</b> Variation

## 3.10.2.5 Analyzer Functions

Command	Parameter	Basic unit	Meaning	Section
<b>SENSe[1]:FUNCTION</b>	'OFF' 'RMS' 'RMSSelectiv' 'PEAK' 'QREak' 'DC' 'THD' 'THDNs ndr' 'MDIS' 'DFD' 'WAF' 'POLarity' 'FFT' 'FIL.Tersimulation' 'WAVeform' 'COHerence' 'RUBBUzz' 'PROTOcol' 'THIRdoct'		<ul style="list-style-type: none"> <li>→ Function measurement off</li> <li>→ RMS measurement ,</li> <li>→ RMS selective measurement</li> <li>→ Peak measurement</li> <li>→ Quasi-peak measurement</li> <li>→ DC measurement</li> <li>→ THD measurement</li> <li>→ THD+N measurement</li> <li>→ MOD DIST measurement</li> <li>→ DFD measurement</li> <li>→ W'ow &amp; flutter measurement</li> <li>→ Polarity measurement</li> <li>→ FFT display</li> <li>→ Filter simulation</li> <li>→ Waveform display</li> <li>→ Coherence Measurement and Transfer Function</li> <li>→ Loudspeaker measurements</li> <li>→ AES/EBU protocol</li> <li>→ Third analysis</li> </ul>	<b>2.6.5</b> <b>ANLR panel</b> <b>FUNCTION</b> → OFF → RMS & S/N → RMS SELECT → PEAK & S/N → QPK & S/N → DC → THD → THD+N/SINAD → MOD DIST → DFD → W'OW & FL → POLARITY → FFT → FILTER SIM. → WAVEFORM → COHERENCE → RUB & BUZZ → PROTOCOL → THIRD OCT

## 3.10.2.5.1 Common Parameters for Analyzer Functions

Command	Parameter	Basic unit	Meaning	Section
<b>SENSe[1]:TRIGger:SETTling:MODE</b> <b>SENSe[1]:FUNCTION:SETTling:MODE</b> <b>SENSe3:FREQUENCY:SETTling:MODE</b> <b>SENSe3:PHASE:SETTling:MODE</b>	OFF EXPOnential FLAT AVERAge		SENS:TRIG:SETT = Settling process for external triggering SENS:FUNC:SETT = Settling process for measurement function SENS3:FREQ:SETT = Settling process for frequency measurement SENS3:PHAS:SETT = Settling process for phase measurement → OFF → Settling with exponential tolerance and resolution characteristic → Settling with tolerance and resolution band → Arithmetic averaging (not for settling with external triggering)	2.6.5.1 <b>ANLR panel</b> Settling → OFF → EXPONENTIAL → FLAT → AVERAGE
<b>SENSe[1]:TRIGger:SETTling:COUNT</b> <b>SENSe[1]:FUNCTION:SETTling:COUNT</b> <b>SENSe3:FREQUENCY:SETTling:COUNT</b> <b>SENSe3:PHASE:SETTling:COUNT</b>	<n> for EXP   FLAT: 2 to 6 for AVER: 2 to 100		Number of test points considered in settling. 3 means that the currently measured value is compared with the two preceding results.	2.6.5.1 <b>ANLR panel</b> Samples
<b>SENSe[1]:TRIGger:SETTling:TOLerance</b> <b>SENSe[1]:FUNCTION:SETTling:TOLerance</b> <b>SENSe3:FREQUENCY:SETTling:TOLerance</b>	<n> 0.001 to 10 %	%	Starting value of exponential tolerance characteristic or tolerance band.	2.6.5.1 <b>ANLR panel</b> Tolerance
<b>SENSe[1]:TRIGger:SETTling:RESolution</b> <b>SENSe[1]:FUNCTION:SETTling:RESolution</b> <b>SENSe3:FREQUENCY:SETTling:RESolution</b> <b>SENSe3:PHASE:SETTling:RESolution</b>	<nu> Value range and units are determined by instrument and function see 2.6.5.1	V FS % dB Hz DEG(°)	Starting value of exponential resolution characteristic or resolution band.	2.6.5.1 <b>ANLR panel</b> Resolution
<b>SENSe[1]:FUNCTION:SETTling:TOUT</b> <b>SENSe3:FREQUENCY:SETTling:TOUT</b> <b>SENSe3:PHASE:SETTling:TOUT</b>	<nu> 0.001 to 10 s	s	Maximum settling time If no settled measurement result is achieved within this time, the measurement is aborted and an invalid result is signalled.	2.6.5.1 <b>ANLR panel</b> Timeout

Command	Parameter	Basic unit	Meaning	Section
<b>SYSTEM:SPEAKER:SOURCE</b>	<b>OFF</b> <b>INP1</b>  <b>INP2</b> <b>IN1And2</b>  <b>FNC1</b> <b>FNC2</b> <b>FN1And2</b> <b>AES1</b>  <b>AES2</b> <b>AE1And2</b>		<p>→ Loudspeaker and headphones output switched off.</p> <p>→ Aural monitoring of input signal of analog analyzers A22 and A110 on channel 1.</p> <p>The signal is available at both output channels.</p> <p>In the DIGITAL analyzer with option Digital Audio I/O (UPL-B2) in the <b>Meas Mode JITTER/PHAS</b> the demodulated jitter signal is applied to the ANLG 110 kHz analyzer and can be listened to.</p> <p>In the DIGITAL analyzer with option Digital Audio I/O (UPL-B2), in the <b>Meas Mode COMMON/INP</b> the superimposed common-mode signal is applied to the digital inputs of the ANLG 110 kHz analyzer and can be monitored.</p> <p>→ The input signal of the analog analyzer A22 and A110 can be monitored on channel 2.</p> <p>→ ... on both channels (stereo).</p> <p>With channel 1 or 2 selected as analyzer input, only the left or, the right headphones output can be used for monitoring.</p> <p>→ Aural monitoring of function output of analog analyzer A22 for all measurement functions (except THD+N) for channel 1.</p> <p>→ ... for channel 2.</p> <p>→ ... for both channels (stereo).</p> <p>→ Aural monitoring of left channel of AES/EBU interface of digital analyzer D48 (Option: Digital Audio Protocol Analysis and Generation UPL-B2).</p> <p>→ ... of right channel ...</p> <p>→ ... of both channels (stereo) ...</p>	2.6.6 <b>ANLR panel</b> <b>SPEAKER</b> → OFF → INPUT Ch1 → INPUT JITT → INPUT COMM → INPUT Ch2 → INPUT Ch1&2 → FUNCT Ch1 → FUNCT Ch2 → FUNCT Ch1&2 → DIG Ch1 → DIG Ch2 → DIG Ch1&2
<b>SYSTEM:SPEAKER:GAIN</b>	<nu> -120 to 120 dB	dB	Amplification or attenuation of function output.	2.6.6 <b>ANLR panel</b> Pre Gain
<b>SYSTEM:SPEAKER:VOLUME</b>	<nu> 0 to 100 %	%	Volume of monitor output	2.6.6 <b>ANLR panel</b> Skp Volume
<b>SYSTEM:PHONE</b>	<b>SPKC</b> <b>PERM</b>		<p>→ Phones output conforms to loudspeaker setting.</p> <p>→ Headphones output permanently switched on.</p>	2.6.6 <b>ANLR panel</b> Phone Out → SPKPhone → PERMANENT

Command	Parameter	Basic unit	Meaning	Section
<b>SYSTEM:SPEAKER[:STATe]</b>	<b>ON</b> <b>OFF</b>		→ Loudspeaker on → Loudspeaker off Command has no effect if option UPL-B5 is not fitted.	2.6.6 <b>ANLR panel</b> LOCAL key

### 3.10.2.5.2 RMS Measurement incl. S/N

Command	Parameter	Basic unit	Meaning	Section
<b>SENSe[1]:FUNCTION</b>	<b>"RMS"</b>		→ RMS measurement	<b>2.6.5</b> <b>ANLR panel</b> FUNCTION → RMS & S/N
<b>SENSe[1]:FUNCTION:DCSuppression</b>	<b>ON</b> <b>OFF</b>		Suppression of DUT DC in the digital analyzer. → DC not considered; corresponds to AC coupling → DC considered in the measurement and displayed; corresponds to DC coupling	<b>2.6.5.1</b> <b>ANLR panel</b> DC Suppres → ON → OFF
<b>SENSe[1]:FUNCTION:SMSSequence</b>	<b>ON</b> <b>OFF</b>		→ S/N (signal-to-noise) measurement on → S/N (signal- to-noise) measurement off	2.6.5.1 <b>ANLR panel</b> S/N Sequ
<b>SENSe[1]:VOLTag POWERj:UNIT[1 2]</b>	see 3.10.4		Display units for RMS measurement	2.4 <b>ANLR panel</b> Unit Ch1/CH2

Command	Parameter	Basic unit	Meaning	Section
<b>SENSe[1]:VOLTage:APERture:MODE</b>	<b>AFASt</b> <b>AUTO</b> <b>TRIGgered</b>  <b>GENTrack</b>  <b>VALue</b>		<p>AFASt and AUTO match the measurement time to the signal frequency by taking the signal period into account. The measurement time is matched as far as possible to the input signal. Maximum algorithmic error:</p> <ul style="list-style-type: none"> <li>→ 1%</li> <li>→ 1‰.</li> <li>→ A special mode is available for <b>RMS measurements</b>, permitting a single <b>delay-free</b> measurement with selectable measurement time to be carried out as soon as the signal exceeds a set trigger threshold for the first time. In conjunction with the generator burst signal this measurement mode permits the first period of a signal to be measured and is particularly suitable for echo-free measurements on loudspeakers.</li> <li>→ Measurement over (at least) one whole period of the generator signal. If required, the generator frequency is matched to the analyzer sampling rate. In the case of high frequencies the measurement time is extended to several periods to increase the measurement accuracy. Particularly suitable for measuring very noisy or distorted signals and for extremely fast sweeps. This measurement method guarantees <b>maximum measurement accuracy at minimum measurement times</b> and should therefore be <b>given preference</b>.</li> <li>If the MODDIST signal is used as generator signal, the measurement time is referred to the LOWER Frequency, which normally dominates.</li> <li>→ Numerical entry of measurement time. For entry of values see next command.</li> </ul>	2.6.5.2 <b>ANLR panel</b> Meas Time → AUTO FAST → AUTO → TRIGGERED → GEN TRACK → VALUE:
<b>SENSe[1]:VOLTage:APERture</b>	<b>&lt;nu&gt;</b> 1 ms ... For value range see 2.6.5.2 → Meas Time	s	Numerical entry of measurement time. Measurement time for steadying the display.	2.6.5.2 <b>ANLR panel</b> Meas Time



Command	Parameter	Basic unit	Meaning	Section
<b>SENSe[1]:VOLTag POWerj:REFerence:MODE</b>	<b>CH1Store</b> <b>CH2Store</b> <b>CH1Meas</b> <b>CH2Meas</b> <b>STORE</b> <b>VALue</b>		<ul style="list-style-type: none"> <li>→ For a two-channel measurement, the current measurement result of channel 1 is stored as a reference.</li> <li>→ For a two-channel measurement, the current measurement result of channel 2 is stored as a reference.</li> <li>→ The value measured in channel 1 is used as a reference for the output of results in reference-related units.</li> <li>→ The value measured in channel 2 is used as a reference for the output of results in reference-related units.</li> <li>→ For a single-channel measurement, the current measurement result is stored as a reference.</li> <li>→ The reference value is entered using the next command.</li> </ul>	2.6.5.1 <b>ANLR panel</b> Reference
<b>SENSe[1]:VOLTag POWerj:REFerence</b>	<b>&lt;nu&gt;</b> Analog instrument 100 pV to 1000 V Digital instrument 0.0 to 1.0 FS	V FS	Numerical entry of reference value.	2.6.5.1 <b>ANLR panel</b> Reference
<b>SENSe:SWEEp:SYNC</b>	<b>NORMAL</b> <b>BLOCK</b>		<p>Permits the speed to be increased for 1-dimensional generator frequency sweeps with the universal generator:</p> <ul style="list-style-type: none"> <li>→ normal speed common for all sweeps</li> <li>→ sweep speed increased after the 2nd sweep; traces are not updated online but only upon completion of the sweep (all at once).</li> </ul> <p>Only available with option UPL-B29 (Digital Audio 96 kHz) in Base Rate Mode (CONF:DAI BRM).</p> <p>In the high rate mode, the sweep can be operated at NORMAL speed only.</p>	<b>2.6.5.1 ANLR panel</b> Sweep Mode → NORMAL → BLOCK
<b>SENSe[1]:NOTChj:STATe[</b>	<b>OFF</b> <b>DB0</b> <b>DB12</b> <b>DB30</b>		<ul style="list-style-type: none"> <li>→ Analog notch filter off;</li> <li>→ Analog notch filter on; no gain</li> <li>→ Analog notch filter on; gain 12 dB</li> <li>→ Analog notch filter on; gain 30 dB</li> </ul>	2.6.5.1 <b>ANLR panel</b> Anlg. Notch → OFF → 0 dB → 12 dB → 30 dB

Command	Parameter	Basic unit	Meaning	Section
<b>SENSe[1]:NOTCh:FREQUENCY:MODE</b>	<b>FIXed</b> <b>GENTrack</b>		→ For numerical entry of notch-filter center frequency see next command. → The notch-filter center frequency tracks the generator frequency.	2.6.5.1 <b>ANLR panel</b> Notch Freq → VALUE: → GEN TRACK
<b>SENSe[1]:NOTCh:FREQUENCY:FIXed</b>	<nu> for analog instr. 10 Hz to 22.5 kHz	HZ	Numerical center frequency of notch filter. For analog instrument only.	2.6.5.1 <b>ANLR panel</b> Notch Freq → VALUE:
<b>SENSe[1]:FILTere[&lt;i&gt;]&gt;:.....</b>	<i> 1 to 3		See 3.10.3 Selecting the Analyzer Filters	2.7.1 <b>ANLR panel</b> Filter
<b>CALCulate:TRANSform:FREQUENCY:STATE</b>	<b>OFF</b> <b>ON</b>		→ No POST-FFT for the selected measurement function → POST-FFT for selected measurement function: see 2.6.5.12 FFT with the following settings available: CALCulate:TRANSform:FREQUENCY:FFT S256 to S8K CALCulate:TRANSform:FREQUENCY:WINDow RECT to KAIS CALCulate:TRANSform:FREQUENCY:START ? CALCulate:TRANSform:FREQUENCY:STOP ? CALCulate:TRANSform:FREQUENCY:RESolution? If the group-delay measurement is selected with command SENSe3:FUNCTION FQGRoupdelay, POST-FFT is always active as the frequency information is obtained from FFT.	2.6.5.1 <b>ANLR panel</b> POST FFT → OFF → ON
<b>SENSe[1]:TRIGger.SETTling:.....</b>			For settling commands see 3.10.2.5.1 Common Parameters for Analyzer Functions	2.3.4.2 <b>ANLR panel</b> Funct Settling

## 3.10.2.5.3 Selective RMS Measurement incl. Sweep

Command	Parameter	Basic unit	Meaning	Section
<b>SENSe[1]:FUNCTION</b>	" <i>RMSselectiv</i> "		Selective RMS measurement	2.6.5 <b>ANLR panel</b> FUNCTION → RMS SELECT
<b>SENSe[1]:FUNCTION:DCSuppression</b>	ON OFF		Suppression of DUT DC in the digital analyzer. → DC not considered; corresponds to AC coupling → DC considered in the measurement and displayed; corresponds to DC coupling	2.6.5.1 <b>ANLR panel</b> DC Suppres → ON → OFF
<b>SENSe[1]:VOLTage:POWerj:UNIT[1 2]</b>	see 3.10.4 Units for IEC Measurement Results		Display units for RMS measurement	2.4 <b>ANLR panel</b> Unit Ch1/CH2
<b>SENSe[1]:VOLTage:APERture:MODE</b>	AFast AUTO GENTrack  VALue		AFast and AUTO: Automatic matching of measurement time to the signal frequency taking the signal period into account. The measurement time is matched as far as possible to the input signal. Maximum algorithmic error → 1% → 1‰ → Measurement over (at least) one whole period of the generator signal. If required, the generator frequency is matched to the analyzer sampling rate. In the case of high frequencies the measurement time is extended to several periods to increase the measurement accuracy. Particularly suitable for measuring very noisy or distorted signals and for extremely fast sweeps. This measurement method guarantees <b>maximum measurement accuracy at minimum measurement times</b> and should therefore be <b>given preference</b> . If the MODDIST signal is used as generator signal, the measurement time is referred to the LOWER Frequency, which normally dominates. → Numerical entry of measurement time. For entry of values see next command.	2.6.5.3 <b>ANLR panel</b> Meas Time → AUTO FAST → AUTO → GEN TRACK → VALUE
<b>SENSe[1]:VOLTage:APERture</b>	<nu> 10 µs to 10s	s	Numerical entry of measurement time. Measurement time for steadying the display.	2.6.5.3 <b>ANLR panel</b> Meas Time

Command	Parameter	Basic unit	Meaning	Section
<b>SENSe[1]:BWIDth[:RESolution]:MODE</b> equivalent to <b>SENSe[1]:BANDwidth[:RESolution]:MODE</b>	<i>PPCT1</i> <i>PPCT3</i> <i>PTOCt</i> <i>POCT12</i> <i>PFIx</i> <i>PFASt</i>  <i>SPCT1</i> <i>SPCT3</i> <i>STOCt</i> <i>SOCT12</i> <i>SFIx</i> <i>SFASt</i>		Bandwidth of bandpass or bandstop of selective RMS filter.  Parameter starting with P ... = bandpass S ... = bandstop  <b>PFAST</b> <b>SFAST:</b> Bandstop filter with only 40 dB attenuation, third-octave bandwidth and particularly short settling time.	2.6.5.3 <b>ANLR panel</b> Bandwidth → BP 1% → BP 3% → BP 1/3 OCT → BP 1/12 OCT → BP FIX: → <b>BP FAST</b> → BS 1% → BS 3% → BS 1/3 OCT → BS 1/12 OCT → BS FIX: → <b>BS FAST</b>
<b>SENSe[1]:BWIDth[:RESolution]</b> equivalent to <b>SENSe[1]:BANDwidth[:RESolution]</b>	<nu> Value range determined by instrument or function	Hz	Numerical entry of arithmetically symmetrical bandwidth.	2.6.5.3 <b>ANLR panel</b> Bandwidth
<b>SENSe[1]:VOLTagE[Power]:REFERENCE:MODE</b>	<i>CH1Store</i> <i>CH2Store</i> <i>CH1Meas</i> <i>CH2Meas</i> <i>STORE</i> <i>GENTrack</i>  <i>VALue</i>		→ For a two-channel measurement, the current measurement result of channel 1 is stored as a reference. → For a two-channel measurement, the current measurement result of channel 2 is stored as a reference. → The value measured in channel 1 is used as a reference for the output of results in reference-related units. → The value measured in channel 2 is used as a reference for the output of results in reference-related units. → For a single-channel measurement, the current measurement result is stored as a reference. → The currently set generator output level is used as a reference. Using the subsequent command <b>SENS:FREQ:FACT &lt;n&gt;</b> the bandpass filter of the RMS SEL measurement in the Freq Mode <b>GENTRACK</b> can be set to any multiple of the fundamental. This allows single harmonics to be measured. → The reference value is entered using the next command.	2.6.5.1 <b>ANLR panel</b> Reference → STORE CH1 → STORE CH2 → MEAS CH1 → MEAS CH2 → STORE → GEN TRACK → VALUE:

Command	Parameter	Basic unit	Meaning	Section
<b>SENSe[1]:VOLTagelPOWER]:REFerence</b>	<nu> Analog instruments 100 pV to 1000 V Digital instrument 0.0 to 1.0 FS	V FS	Numerical entry of reference value.	2.6.5.1 <b>ANLR</b> panel Reference

## Sweep for selective RMS measurement

Command	Parameter	Basic unit	Meaning	Section
<b>SENSe[1]:FREQUENCY:MODE</b>	<b>FIXed[CW]</b> <b>SWEEp</b>  <b>LIST</b>  <b>MULTisine</b>  <b>GENTrack</b>  <b>CH1</b> <b>CH2</b>		<p>→ Presetting for fixed frequency of selective RMS measurement. Numerical entry with <b>SENSe[1]:FREQUENCY:FIXed[CW]&lt;nu&gt;</b></p> <p>→ Frequency sweep of selective RMS measurement.</p> <p>The sweep parameters are determined by the following user specifications:</p> <p><b>SENSe[1]:FREQUENCY:STARt[STOP &lt;nu&gt;</b></p> <p><b>SENSe[1]:SWEEp:SPACing LINear[LOGarithmic]</b></p> <p><b>SENSe[1]:SWEEp:STEP &lt;nu&gt;</b></p> <p><b>SENSe[1]:SWEEp:POINts &lt;n&gt;</b></p> <p>→ List sweep of frequency of selective RMS measurement.</p> <p>The sweep parameters are read from the file specified under <b>MMEMory:LOAD:LIST FREQUENCY, "filename"</b> For format of block/list files see 2.9.1.3 Format of Block/Listen Data.</p> <p>→ The frequency of the selective RMS measurement is set consecutively to the multisine frequencies specified in the generator panel (see 2.5.4.4 <b>MULTISINE</b>). The sweep is similar to a LIST sweep.</p> <p>→ The frequency of the selective RMS measurement tracks the current generator frequency.</p> <p>By means of the factor (see next command <b>SENS:FREQ:FACT &lt;n&gt;</b>) it can be determined whether the center frequency should directly track the generator frequency (factor = 1) or be a multiple thereof. If the factor is an integral multiple, it may be used for measuring single harmonics. The bandpass center frequency can be tracked to the generator signal functions <b>SINE, MULTISINE, BURST</b> or <b>SINE2 PULSE</b>; only; any other signal function causes an error message. The frequency of the selective RMS measurement tracks the frequency measured in</p> <p>→ channel 1</p> <p>→ channel 2.</p>	<p>2.6.5.3 <b>ANLR panel</b> SWEEP CTRL → OFF → AUTO SWEEP MANU SWEEP → AUTO LIST MANU LIST → GEN MLTSINE  FREQ MODE → GEN TRACK → FREQ CH1 → FREQ CH2</p>
<b>SENSe:FREQUENCY:FACTor</b>	<b>&lt;nu&gt;</b> MLT 1 to 20 for RMS selective measurements		Factor by which the tracking bandpass filter is higher than the generator frequency with setting <b>GENTRACK (SENS:FREQ:MODE GENT)</b> .	<p>2.6.5.3 <b>ANLR panel</b> FREQ MODE → Factor</p>

Command	Parameter	Basic unit	Meaning	Section
<b>SENSE:SWEEP:SYNC</b>	<b>NORMAL</b> <b>FAST</b> <b>BLOCK</b>		Permits the speed of 1-dimensional sweeps with the universal generator to be increased. → Normal speed used for any kind of sweep → Sweep speed increased as from 2nd sweep → Sweep speed increased again as from 2nd sweep; update of curve not online but only upon completion of the sweep (all at once).  Only available with option UPL-B29 (Digital Audio 96 kHz) in Base Rate Mode (CONF:DAI BRM). In the high rate mode, the sweep can be operated at NORMAL speed only.	<b>2.6.5.3</b> <b>ANLR panel</b> Sweep Mode → NORMAL → FAST → BLOCK
<b>SENSe[1]:NOTCh[:STATe]</b>	<b>DB12</b> <b>DB30</b> <b>DB0</b> <b>OFF</b>		→ Analog notch filter on; gain 12 dB → Analog notch filter on; gain 30 dB → Analog notch filter on; no gain → Analog notch filter off. The notch filter can only be set in the analog instruments when a bandstop filter has been selected for SENS:BWID:MODE.	<b>2.6.5.1</b> <b>ANLR panel</b> Anlg. Notch → 12 dB Auto → 30 dB Auto → 0 dB → OFF
<b>SENSe[1]:FILTer2:.....</b>			See 3.10.3 Selecting the Analyzer Filters Particularly when monitoring weak residual signals amplified by means of Pre Gain, a highpass filter should be used for DC suppression to avoid the signal to be distorted or suppressed altogether. In conjunction with a selective RMS measurement <b>filter No. 2 must</b> be selected as filter No. 1 is already used in the UPL as a selective RMS bandpass or bandstop filter. 3.10.3 Selecting the Analyzer Filters	<b>2.7.1</b> <b>ANLR panel</b> Filter
<b>SENSe[1]:FREQUency[:FIXed[CW]]</b>	<b>&lt;nu&gt;</b> Value range determined by instrument or function	Hz	Numerical entry of frequency for selective RMS measurement.	<b>2.6.5.3</b> <b>ANLR panel</b> FREQ MODE → FIX
<b>SENSe[1]:SWEep:MODE</b>	<b>AUTO</b> <b>MANual</b>		Automatic sweep → This command in conjunction with command SENSE[1]:FREQUency:MODE SWEEp sets the AUTO SWEEP mode. → This command in conjunction with command SENSE[1]:FREQUency:MODE SWEEp sets the MANU SWEEP mode. Pressing the LOCAL key activates the spinwheel.	<b>2.6.5.3</b> <b>ANLR panel</b> SWEEP CTRL → AUTO SWEEP → MANU SWEEP

Command	Parameter	Basic unit	Meaning	Section
<b>SENSe[1]:LIST:MODE</b>	<b>AUTO</b> <b>MANUAL</b>		Automatic list sweep → This command in conjunction with command SENSE[1]:FREQUENCY:MODE LIST sets the AUTO LIST mode. → This command in conjunction with command SENSE[1]:FREQUENCY:MODE SWEep sets the MANU LIST mode. Pressing the LOCAL key activates the spinwheel.	2.6.5.3 <b>ANLR panel</b> SWEEP CTRL → AUTO LIST → MANU LIST
<b>SENSe[1]:FREQUENCY:START</b> <b>SENSe[1]:FREQUENCY:STOP</b>	<b>&lt;nu&gt;</b> Value range determined by instrument or function	Hz	Start and stop frequency for frequency sweep of selective RMS measurement.	2.6.5.3 <b>ANLR panel</b> SWEEP CTRL → Start   Stop
<b>SENSe[1]:SWEep:SPACing</b>	<b>LINear</b> <b>LOGarithmic</b>		→ Linear sweep spacing → Logarithmic sweep spacing	2.6.5.3 <b>ANLR panel</b> Spacing → LIN → LOG
<b>SENSe[1]:SWEep:POINTS</b>	<b>&lt;n&gt;</b> 2 to 1024		Number of sweep steps. Depending on the selected SPACing (SENSe[1]:SWEep:SPACing LINear LOGarithmic), the sweep frequency range between "START" and "STOP" is divided into <n> linear or logarithmic sweep points.	2.6.5.3 <b>ANLR panel</b> Points
<b>SENSe[1]:SWEep:STEP</b>	<b>&lt;nu&gt;   &lt;n&gt;</b> The selected step size should be so wide that not more than 1023 single steps (= 1024 sweep points) are obtained. It should not exceed the absolute difference between STOP and START.	→	Sweep step size Depending on selected SPACing SENSe[1]:SWEep:SPACing LINear LOGarithmic, the sweep frequency range between "START" and "STOP" is divided into linear steps in Hz or logarithmic steps in the form of a multiplier. SENSe[1]:SWEep:SPACing LINear: Hz SENSe[1]:SWEep:SPACing LOGarithmic: No unit because of multiplication factor.	2.6.5.3 <b>ANLR panel</b> Steps



Command	Parameter	Basic unit	Meaning	Section
<b>MMEM</b> ory: <b>LOAD:LIST</b>	<b>FRE</b> quency, " <b>filename</b> " " " = path and filename of frequency list for a LIST sweep of a selective RMS measurement, eg "c:\UPL\ref\swpfst.lst"		Loading a frequency list for the list sweep.	2.6.5.3 2.9.1.3 <b>ANLR</b> panel SWEEP CTRL → Filename
<b>SENSe</b> [1]: <b>FUNCTION:SETT</b> ling:.....			For settling commands see 3.10.2.5.1 Common Parameters for Analyzer Functions	2.3.4.2 <b>ANLR</b> panel Fnct Sett

## 3.10.2.5.4 Peak and Quasi-Peak Measurement incl. S/N

Command	Parameter	Basic unit	Meaning	Section
<b>SENSe[1]:FUNCTION</b>	"PEAK"		→ Peak measurement	<b>2.6.5</b> <b>ANLR panel</b> FUNCTION → PEAK & S/N
<b>SENSe[1]:FUNCTION</b>	"QPEak"		→ Quasi-peak measurement	<b>2.6.5</b> <b>ANLR panel</b> FUNCTION → QPK & S/N
<b>SENSe[1]:VOLTage POWer]:UNIT[1 2]</b>	see 3.10.4 Units for IEC Measurement Results		Display units for RMS measurement	<b>2.4</b> <b>ANLR panel</b> Unit Ch1/CH2
<b>SENSe[1]:FUNCTION:SNSequence</b>	ON OFF		→ S/N (signal-to-noise) measurement on. → S/N (signal-to-noise) measurement off.	<b>2.6.5.1</b> <b>ANLR panel</b> S/N Sequ → ON → OFF
<b>SENSe[1]:FUNCTION:MMODE</b>	<i>PPEak</i> <i>NPEak</i> <i>PTOPeak</i> <i>PABSolut</i>		→ PK+ value → PK- value → Peak-to-peak value → Absolute peak value	<b>2.6.5.4</b> <b>ANLR panel</b> Meas Mode → PK + → PK - → PK to PK → PK abs
<b>SENSe[1]:VOLTage:INTVTime:MODE</b>	<i>SFAST</i> <i>FAST</i> <i>SLOW</i> <i>FIXed</i> <i>VALue</i>		→ 50 ms → 200 ms monitoring interval for <b>peak</b> search → 1000 ms → s monitoring interval for <b>quasi-peak</b> search → Numerical entry of interval time. For entry of values see next command.	<b>2.6.5.4</b> <b>ANLR panel</b> Intv Time → FIX 50ms → FIX 200ms → FIX 1000ms → FIX 3 SEC → VALUE:

Command	Parameter	Basic unit	Meaning	Section
<b>SENSe[1]:VOLTage:INTVtime</b>	<nu> 20 ms to 10s	s	Numerical entry of interval time. Monitoring interval for peak search	2.6.5.4 <b>ANLR panel</b> IntV Time
<b>SENSe[1]:VOLTage[POWER]:REFERENCE:MODE</b>	<b>CH1Store</b> <b>CH2Store</b> <b>CH1Meas</b> <b>CH2Meas</b> <b>STORE</b> <b>GENTrack</b> <b>VALue</b>		→ For a two-channel measurement, the current measurement result of channel 1 is stored as a reference. → For a two-channel measurement, the current measurement result of channel 2 is stored as a reference. → The value measured of channel 1 is used as a reference for theresults in reference-related units. → The value measured of channel 2 is used as a reference for the results in reference-related units. → For a single-channel measurement, the current measurement result is stored as a reference. → The currently set generator output level is used as a reference. → The reference value is entered using the next command.	2.6.5.1 <b>ANLR panel</b> Reference → STORE CH1 → STORE CH2 → MEAS CH1 → MEAS CH2 → STORE → GEN TRACK → VALUE:
<b>SENSe[1]:VOLTage[POWER]:REFERENCE</b>	<nu> Analog instrument 100 pV to 1000V Digital instrument 0.0 to 1.0 FS	V FS	Numerical entry of reference value.	2.6.5.1 <b>ANLR panel</b> Reference
<b>SENSe[1]:NOTCh[:STATe]</b>	<b>DB0</b> <b>DB12</b> <b>DB30</b> <b>OFF</b>		→ Analog notch filter on; no gain → Analog notch filter on; gain 12 dB → Analog notch filter on; gain 30 dB → Analog notch filter off;	2.6.5.1 <b>ANLR panel</b> Anlg. Notch → 0 dB → 12 dB → 30 dB → OFF
<b>SENSe[1]:NOTCh:FREQUENCY:MODE</b>	<b>FIXed</b> <b>GENTrack</b>		→ For numerical entry of notch-filter center frequency see next command. → The center frequency of the notch filter tracks the generator frequency.	2.6.5.1 <b>ANLR panel</b> Notch Freq → VALUE: → GEN TRACK

Command	Parameter	Basic unit	Meaning	Section
<b>SENSe[1]:NOTCh:FREQUency:FIXed</b>	<nu> for analog instr. 10 Hz to 22.5 kHz	Hz	Numerical center frequency of notch filter.	2.6.5.1 <b>ANLR panel</b> Notch Freq → VALUE:
<b>SENSe[1]:FILTEr&lt;i&gt;:.....</b>	<i> 1 to 3		See 3.10.3 Selecting the Analyzer Filters  Only available with option UPL-B29 (Digital Audio 96 kHz) in Base Rate Mode (CONF:DAI BRM). In the high rate mode (CONF:DAI HRM), the measurement functions PEAK and QPEak can be operated without filter.	2.7.1 <b>ANLR panel</b> Filter
<b>SENSe[1]:FUNction:SETTling:.....</b>			For settling commands see 3.10.2.5.1 Common Parameters for Analyzer Functions	2.3.4.2 <b>ANLR panel</b> Funct SettI

## 3.10.2.5.5 DC Measurement

Command	Parameter	Basic unit	Meaning	Section
<b>SENSe[1]:FUNCTION</b>	"DC"		→ DC measurement	2.6.5 <b>ANLR panel</b> FUNCTION → DC
<b>SENSe[1]:VOLTage POWER UNIT[1 2]</b>	see 3.10.4 Units for IEC Measurement Results		Display units for RMS measurement	2.4 <b>ANLR panel</b> Unit Ch1/CH2
<b>SENSe[1]:VOLTage:APERture:MODE</b>	<b>FAST</b> <b>VALue</b>		→ 200 ms integration time for steadying the display. → Numerical entry of integration time. For entry of values see next command.	2.6.5.5 <b>ANLR panel</b> Meas Time → FIX 200ms → VALUE:
<b>SENSe[1]:VOLTage POWER :REFerence:MODE</b>	<b>CH1Store</b> <b>CH2Store</b> <b>CH1Meas</b> <b>CH2Meas</b> <b>STORE</b> <b>GENTrack</b> <b>VALue</b>		→ For a two-channel measurement, the current measurement result of channel 1 is stored as a reference. → For a two-channel measurement, the current measurement result of channel 2 is stored as a reference. → The value measured of channel 1 is used as a reference for the results in reference-related units. → The value measured of channel 2 is used as a reference for the results in reference-related units. → For a single-channel measurement, the current measurement result is stored as a reference. → The currently set generator output level is used as a reference. → The reference unit is specified by the next command.	2.6.5.1 <b>ANLR panel</b> Reference → STORE CH1 → STORE CH2 → MEAS CH1 → MEAS CH2 → STORE → GEN TRACK → VALUE:
<b>SENSe[1]:VOLTage POWER :REFerence</b>	<nu> Analog instrument - 1000 V to 1000 V	V	Numerical entry of reference value.	2.6.5.1 <b>ANLR panel</b> Reference
<b>SENSe[1]:FUNCTION:SETTling:....</b>			For settling commands see 3.10.2.5.1 Common Parameters for Analyzer Functions	2.3.4.2 <b>ANLR panel</b> Funct Sett1

## 3.10.2.5.6 THD Measurement

Command	Parameter	Basic unit	Meaning	Section
<b>SENSe[1]:FUNCTION</b>	"THD"		THD measurement	2.6.5 <b>ANLR panel</b> FUNCTION → THD
<b>SENSe[1]:FUNCTION:MMODE</b>	<b>SELeCtdi</b> <b>LSELeCtdi</b> <b>DALL</b> <b>LDALI</b> <b>DODD</b> <b>LDODd</b> <b>DEVen</b> <b>LDEVen</b>		<p>→ Any combination of harmonics from d2 to d9 can be set with the following command: Result in dB</p> <p>→ Selection of harmonics to be measured: Result in V (analog) or FS (digital)</p> <p>→ All harmonics from d2 to d9 Result in dB</p> <p>→ All uneven harmonics: Result in V (analog) or FS (digital)</p> <p>→ d3, d5, d7, d9 Result in dB</p> <p>→ All even harmonics: Result in V (analog) or FS (digital)</p> <p>→ d2, d4, d6, d8 Result in dB</p>	2.6.5.6 <b>ANLR panel</b> Meas Mode →SELeCT di → LEV SEl di → All di → LEV All di → All odd di → LEV odd di → All even di → LEV even di
<b>SENSe[1]:FUNCTION:DIStortion</b>	<n> *)		Decimal equivalent of integer <n> for any combination of harmonics, eg d2, d4, d6, d9, is desired; binary: 10010101; decimal equivalent <n> = 149	2.6.5.6 <b>ANLR panel</b> → di2468
<b>SENSe[1]:FUNCTION:DMODE</b>	<b>FAST</b> <b>PRECISION</b>		<p>→ Analog notch switched off.</p> <p>→ Analog notch switched on when the applied signal is of good quality.</p>	2.6.5.6 <b>ANLR panel</b> Dyn Mode → FAST → PRECISION
<b>SENSe[1]:UNIT</b>	<b>PCTIDB</b>		Display units for results of THD measurements.	2.4 <b>ANLR panel</b> Unit

Command	Parameter	Basic unit	Meaning	Section
<b>SENSE[1]:VOLTage POWER :REFerence</b>	<nu> Analog Instruments: 100 pV to 1000 V Digital Instrument: 100 pFS to 100 FS	V FS	Numerical entry of reference value in reference-related level units. SENS:FUNC:MMOD LSEL   LDAL   LDOD   LDEV	2.6.5.1 <b>ANLR panel</b> Ref Volt
<b>SENSe[1]:VOLTage:FUNDamental:MODE</b>	<b>AUTO</b> <b>VALue</b>		Determining the fundamental frequency: Automatically by frequency measurement. Numerical entry of fundamental frequency. For entry of values see next command.	2.6.5.6 <b>ANLR panel</b> Fundamentl
<b>SENSe[1]:VOLTage:FUNDamental/</b>	<nu> Value range determined by instrument or function	Hz	Numerical entry	2.6.5.6 <b>ANLR panel</b> Fundamentl
<b>SENSe[1]:FUNCTION:SETTling:....</b>			For settling command see 3.10.2.5.1 Common Parameters for Analyzer Functions	2.3.4.2 <b>ANLR panel</b> Funct Sett1

\*)

MSB	di9	di8	di7	di6	di5	di4	di3	LSB	Data bit
128	64	32	16	8	4	2	1		Harmonics
									Weighting

Example: di1, di3, di5 and di7  
Data word: 10101010  
Weighting = 2+8+32+128  
Decimal equivalent: =170

## 3.10.2.5.7 THD + N / Sinad Measurement

Command	Parameter	Basic unit	Meaning	Section
<b>SENSe[1]:FUNCTION</b>	"THD <sub>Sinad</sub> "		→ THD+N measurement	<b>2.6.5</b> <b>ANLR panel</b> FUNCTION → THD+N/SINAD
<b>SENSe[1]:FUNCTION:MMODE</b>	<b>THDN</b> <b>LTHDn</b> <b>SNDRatio</b> <b>NOISE</b> <b>LNOise</b>		Result display as → THD+N value in dB → THD+N RMS value in V (analog) or FS (digital) → SINAD value in negative dB → Same as THD+N but without harmonics weighting, in dB → Same as THD+N RMS value but without harmonics weighting, in V (analog) or FS (digital)	<b>2.6.5.7</b> <b>ANLR panel</b> Meas Mode → THD+N → LEVEL THD+N → SINAD → NOISE → LEVEL NOISE
<b>SENSe[1]:FUNCTION:DMODE</b>	<b>FAST</b> <b>PRECISION</b>		→ Analog notch filter switched off. → Analog notch filter switched on when the applied signal is of good quality.	<b>2.6.5.7</b> <b>ANLR panel</b> Dyn Mode → FAST → PRECISION
<b>SENSe:FUNCTION:APERture:MODE</b>	<b>SLOW</b> <b>FAST</b> <b>SFAST</b>		Selection of measurement speed → Measurement using FFT size 8192 → Measurement using FFT size 2048 → Measurement using FFT size 512	<b>2.6.5.7</b> <b>ANLR panel</b> Meas Time → SLOW → FAST → SUPERFAST
<b>SENSe[1]:THDN:REJection</b>	<b>NARROW</b> <b>WIDE</b>		Sets the characteristic of the notch filter in the digital instrument. → The noise is measured close to the carrier. → An two-pole notch filter is additionally taken into account to evaluate attenuated harmonics in the vicinity of the carrier.	<b>2.6.5.7</b> <b>ANLR panel</b> Rejection → NARROW → WIDE
<b>SENSe[1]:UNIT</b>	<b>PCTIDB</b>		Display units for results of THD+N measurement	<b>2.4</b> <b>ANLR panel</b> Unit



Command	Parameter	Basic unit	Meaning	Section
<b>SENSe[1]:VOLTage:REFERence</b>	<nu> Analog Instruments: 100 pV to 1000 V Digital Instrument: 100 pFS to 100 FS	V FS	Numerical entry of reference value for measurement response in reference-related level units for the setting SENS:FUNC:MMOD LTHD   LNO	<b>2.6.5.1 ANLR-Panel</b> Ref Volt
<b>SENSe[1]:VOLTage:FUNDamental:MODE</b>	<b>AUTO</b> <b>VALUE</b>		Determining the fundamental frequency: → Automatically by frequency measurement. → Numerical entry of fundamental frequency. For entry of values see next command.	<b>2.6.5.7 ANLR panel</b> Fundamentl → AUTO → VALUE:
<b>SENSe[1]:VOLTage:FUNDamental</b>	<nu> Value range determined by instrument or function	Hz	Numerical entry of fundamental frequency	<b>2.6.5.7 ANLR panel</b> Fundamentl
<b>SENSe[1]:FILTER1:.....</b>			See 3.10.3 Selecting the Analyzer Filters	<b>2.7.1 ANLR panel</b> Funct Sett1
<b>CALCulate:TRANSform:FREQUENCY:STATE</b>	<b>OFF</b> <b>ON</b>		→ No POST-FFT for the selected measurement function → POST-FFT for selected measurement function (see 3.10.2.5.12 FFT) CALC:TRAN:FREQ:FT S256 to S8K CALC:TRAN:FREQ:WIND RECT to KAIS CALC:TRAN:FREQ:STAR? CALC:TRAN:FREQ:STOP? CALCe:TRAN:FREQ:RES?	<b>2.6.5.1 ANLR panel</b> POST FFT → OFF → ON
<b>CALCulate:TRANSform:FREQUENCY:FFT</b>	<b>S512</b> <b>S1K</b> <b>S2K</b> <b>S4K</b> <b>S8K</b>		FFT Size → 512 lines → 1024 lines → 2048 lines → 4096 lines → 8192 lines	<b>2.6.5.12 ANLR-Panel</b> FFT Size → 512 → 1024 → 2048 → 4096 → 8192

Command	Parameter	Basic unit	Meaning	Section
<b>SENSe[1]:FREQUENCY:LiMit:UPPer</b>	<nu> Value range determined by instrument or function	Hz	Upper band limit for THD+N measurement function	2.6.5.7 <b>ANLR panel</b> → Frq Lim Upp
<b>SENSe[1]:FREQUENCY:LiMit:LOWer</b>	<nu> Value range determined by instrument or function	Hz	Lower band limit for THD+N measurement function	2.6.5.7 <b>ANLR panel</b> → Frq Lim Low
<b>SENSe[1]:FUNCTION:SETTling:.....</b>			For settling commands see 3.10.2.5.1 Common Parameters for Analyzer Functions	2.7.1 <b>ANLR panel</b> Fnct SettI
<b>SENSe:VOLTage:EQUALize[:STATe]</b>	<b>ON</b> <b>OFF</b>		Activation/deactivation of an equalizer table consisting of frequency information and associated voltage gain factors. → The equalizer is switched on. The command that follows is accepted. The THD+N value is calculated from the equalized FFT spectrum. → The equalizer is switched off. The THD+N value is calculated from the original FFT spectrum.	2.6.5.7 <b>ANL Panel</b> Equalizer → ON → OFF
<b>MMEMory:LOAD:LIST SENSE,</b>	'filename'		Command for entering the name of the equalizer file. Only permissible with SENS:VOLT:EQU ON	2.6.5.7 <b>ANL Panel</b> Equal. file

## 3.10.2.5.8 MOD DIST

Command	Parameter	Basic unit	Meaning	Section
<b>SENSe[1]:FUNCTION</b>	" <i>MDIS</i> "		MOD-DIST measurement. Measurement with double-sine (similar to SMPTE)	2.6.5 <b>ANLR panel</b> FUNCTION → MODDIST
<b>SENSe[1]:FUNCTION:DMODE</b>	<b>FAST</b> <b>PRECision</b>		→ Analog notch filter switched off. → Analog notch filter switched on if the applied signal is of good quality.	2.6.5.8 <b>ANLR panel</b> Dyn Mode → FAST → PRECISION
<b>SENSe[1]:UNIT</b>	<b>PCTIDB</b>		Display units for results of MOD-DIST measurement.	2.4 <b>ANLR panel</b> Unit
<b>SENSe[1]:FUNCTION:SETTling:....</b>			For settling commands see 3.10.2.5.1 Common Parameters for Analyzer Functions	2.3.4.2 <b>ANLR panel</b> Funct Sett1

## 3.10.2.5.9 DFD

Command	Parameter	Basic unit	Meaning	Section
<b>SENSe[1]:FUNCTION</b>	"DFD"		→ Difference frequency distortion measurement	2.6.5 <b>ANLR panel</b> FUNCTION → DFD
<b>SENSe[1]:UNIT</b>	PCTIDB		Display units for results of DFD measurement	2.4 <b>ANLR panel</b> Unit
<b>SENSe[1]:FUNCTION:MMODE</b>	D2 D3		→ Intermodulation distortion d2 → Intermodulation distortion d3	2.6.5.9 <b>ANLR panel</b> Meas Mode → d2 (IEC268) → d3 (IEC268) → d2 (IEC118) → d3 (IEC118)
<b>SENSe[1]:FUNCTION:DMODE</b>	FAST PRECision		→ Analog notch filter switched off. → Analog notch filter switched on if the applied signal is of good quality.	2.6.5.9 <b>ANLR panel</b> Dyn Mode → FAST → PRECISION
<b>SENSe[1]:FUNCTION:SETTling:.....</b>			For settling commands see 3.10.2.5.1 Common Parameters for Analyzer Functions	2.3.4.2 <b>ANLR panel</b> Funct SettI

## 3.10.2.5.10 Wow &amp; Flutter

Command	Parameter	Basic unit	Meaning	Section
<b>SENSe[1]:FUNCTION</b>	"WAF"		→ Wow & flutter measurement	2.6.5 <b>ANLR panel</b> FUNCTION → WOW & FL
<b>SENSe[1]:FUNCTION:STANdard</b>	<b>NAB</b> <b>JIS</b> <b>DINiec</b> <b>SI05</b> <b>SI10</b>		→ W&F acc. to NAB → W&F acc. to JIS → W&F acc. to DIN/IEC → W&F, 2-sigma, 5 s. → W&F, 2-sigma, 10 s	2.6.5.10 <b>ANLR panel</b> Rule → NAB → JIS → DIN/IEC → 2 Sigma 5 s → 2 Sigma 10s
<b>SENSe[1]:FUNCTION:WEIGHting</b>	<b>ON</b> <b>OFF</b>		→ W&F weighting filter on → W&F weighting filter off	2.6.5.10 <b>ANLR panel</b> Weighting → ON → OFF
<b>SENSe[1]:UNIT</b>	<b>PCT</b>		No further display unit selectable.	2.4 <b>ANLR panel</b> Unit
<b>CALCulate:TRANSform:FREQUENCY:STATE</b>	<b>OFF</b> <b>ON</b>		→ No POST-FFT for selected measurement function → POST-FFT for selected measurement function (see 3.10.2.5.12 FFT) CALC:TRAN:FREQ:FFT S256 to S8K CALC:TRAN:FREQ:WIND RECT to KAIS CALC:TRAN:FREQ:STAR? CALC:TRAN:FREQ:STOP? CALC:TRAN:FREQ:RES?	2.6.5.1 <b>ANLR panel</b> POST FFT → OFF → ON
<b>SENSe[1]:FUNCTION:SETTling:.....</b>			For settling commands see 3.10.2.5.1 Common Parameters for Analyzer Functions	2.3.4.2 <b>ANLR panel</b> Fnct Settll

## 3.10.2.5.11 POLARITY

Command	Parameter	Basic unit	Meaning	Section
<b>SENSe[1]:FUNCTION</b>	"POLarity"		→ Polarity test of DUT.	2.6.5 <b>ANLR panel</b> FUNCTION → POLARITY

## 3.10.2.5.12 FFT

Command	Parameter	Basic unit	Meaning	Section
<b>SENSe[1]:FUNCTION</b>	"FFT"		→ FFT measurement function	2.6.5.12 <b>ANLR panel</b> Function → FFT
<b>SENSe[1]:FUNCTION:DCSuppression</b>	<b>ON</b> <b>OFF</b>		Suppression of DUT DC in the digital analyzer. → DC not considered; corresponds to AC coupling → DC considered in the measurement and displayed; corresponds to DC coupling	2.6.5.1 <b>ANLR panel</b> DC Suppres → ON → OFF
<b>SENSe[1]:VOLTage POWER :UNIT[1 2]</b>	see 3.10.4 Units for IEC Measurement Results		Display units for RMS measurement	2.4 <b>ANLR panel</b> Unit Ch1/CH2

Command	Parameter	Basic unit	Meaning	Section
<b>SENSe[1]j:VOLTage POWerj:REFerence:MODE</b>	<b>CH1Store</b> <b>CH2Store</b> <b>CH1Meas</b> <b>CH2Meas</b> <b>STORE</b> <b>GENTrack</b> <b>VALue</b>		<ul style="list-style-type: none"> <li>→ For a two-channel measurement, the current measurement result of channel 1 is stored as a reference.</li> <li>→ For a two-channel measurement, the current measurement result of channel 2 is stored as a reference.</li> <li>→ The value measured of channel 1 is used as a reference for the results in reference-related units.</li> <li>→ The value measured of channel 2 is used as a reference for the results in reference-related units.</li> <li>→ For a single-channel measurement, the current measurement result is stored as a reference.</li> <li>→ The currently set generator output level is used as a reference.</li> <li>→ The reference unit is specified by the next command.</li> </ul>	2.6.5.1 <b>ANLR panel</b> Reference → STORE CH1 → STORE CH2 → MEAS CH1 → MEAS CH2 → STORE → GEN TRACK → VALUE:
<b>SENSe[1]j:VOLTage POWerj:REFerence</b>	<b>&lt;nu&gt;</b> Value range determined by instrument or function	V FS	Numerical entry of reference value.	2.6.5.1 <b>ANLR panel</b> Reference
<b>SENSe[1]j:CHANnel:DElay</b>	<b>&lt;nu&gt;</b> -10 to 10 s	s	<p>Interchannel delay</p> <p>Delay compensation of the DUT by entering the time by which channel 1 is to be delayed with respect to channel 2. If channel 2 has a shorter delay than channel 1, this can be compensated for by entering a negative value.</p> <p>Available only for two-channel measurements in instruments A22 and D48 and Zoom FFT off ("CALC:TRAN:FREQ:ZOOM 1")</p>	2.6.5.12 <b>ANLR-Panel</b> Chan Delay
<b>SENSe[1]j:NOTChj:STATe </b>	<b>DB12</b> <b>DB30</b> <b>DB0</b> <b>OFF</b>		<ul style="list-style-type: none"> <li>→ Analog notch filter on; gain 12 dB</li> <li>→ Analog notch filter on; gain 30 dB</li> <li>→ Analog notch filter on; no gain</li> <li>→ Analog notch filter off;</li> </ul>	2.6.5.1 <b>ANLR panel</b> Anlg. Notch → 0 dB → 12 dB → 30 dB → OFF

Command	Parameter	Basic unit	Meaning	Section
<b>SENSe[1]:NOTCh:FREQUENCY:MODE</b>	<b>FIXed</b> <b>GENTrack</b>		→ For numerical entry of notch-filter center frequency see next command. → Center frequency of notch filter tracks the generator frequency.	2.6.5.1 <b>ANLR panel</b> Notch Freq → VALUE: → GEN TRACK
<b>SENSe[1]:NOTCh:FREQUENCY:FIXed</b>	<b>&lt;nu&gt;</b> Value range determined by instrument or function	HZ	Numerical entry of notch-filter center frequency.	2.6.5.1 <b>ANLR panel</b> Notch Freq → VALUE:
<b>SENSe[1]:FILTEr&lt;i&gt;:...</b>	<b>&lt;i&gt;</b> 1 to 3		See 3.10.3 Selecting the Analyzer Filters  The three filters are available with: • Analyzer ANLG 22 kHz (INST2 A22) or • Analyzer DIGITAL (INST2 D48) in Meas Mode AUDIO DATA (SENS:DIG:FEED ADAT)  No filter can be switched on: • Analyzer ANLG 110kHz • Option UPL-B29 (Digital Audio 96 kHz) in high rate mode (CONF:DAI HRM)	2.7.1 <b>ANLR-Panel</b> Filter
<b>CALCulate:TRANSform:FREQUENCY:FFT</b>	<b>S256</b> <b>S512</b> <b>S1K</b> <b>S2K</b> <b>S4K</b> <b>S8K</b>		FFT size → 256 lines → 512 lines → 1024 lines → 2048 lines → 4096 lines → 8192 lines	2.6.5.12 <b>ANLR panel</b> FFT Size → 256 → 512 → 1024 → 2048 → 4096 → 8192
<b>CALCulate:TRANSform:FREQUENCY: AVERAGE</b>	<b>&lt;n&gt;</b> 1 to 256		Number of averaging procedures for optimum noise suppression.	2.6.5.12 <b>ANLR panel</b> Average



Command	Parameter	Basic unit	Meaning	Section
<b>CALCulate:TRANSform:FREQUENCY:AVERAGE:TCONTrol</b>	<b>NORMAL</b> <b>EXPONENTIAL</b>		→ The specified number of FFTs is performed, intermediate results are added and then divided by this number. → Averaging is performed continuously.	2.6.5.12 <b>ANLR panel</b> Avg Mode → NORMAL → EXPONENTIAL
<b>CALCulate:TRANSform:FREQUENCY:START?</b> <b>CALCulate:TRANSform:FREQUENCY:STOP?</b>	<b>&lt;nu&gt;</b> Query only		Queries the beginning and end of FFT, depending on CENTER and SPAN. The response is <b>&lt;nu&gt;</b> in Hz.	2.6.5.12 <b>ANLR panel</b> Start / Stop
<b>CALCulate:TRANSform:FREQUENCY:CENTER</b>	<b>&lt;nu&gt;</b> Value range determined by instrument or function	Hz	Center frequency for FFT calculation	2.6.5.12 <b>ANLR panel</b> Center
<b>CALCulate:TRANSform:FREQUENCY:ZOOM</b>	<b>&lt;n&gt; = 1</b> <b>1 to 128</b> for instr. A22 a, D48 n = 1, 2, 4, 8, 16, 32, 64, 128 A110 = n = 1, 2, 4, 8, 16		Zoom FFT off (standard FFT) FFT zoom factor Contrary to the manual mode, the zoom factor instead of the SPAN is entered in the IEC/IEEE-bus mode. The SPAN being a function of the zoom factor it can be determined by the following query.	2.6.5.12 <b>ANLR panel</b> Zoom-FFT
<b>CALCulate:TRANSform:FREQUENCY:SPAN?</b>	<b>&lt;nu&gt;</b> Query only		Queries the frequency range around the center frequency as a function of the zoom factor. The response is <b>&lt;nu&gt;</b> in Hz. Contrary to the manual mode, SPAN can only be read in but not entered in the IEC/IEEE-bus mode. The SPAN value can be changed by changing the zoom factor and modifying the sampling frequency and the oversampling factor.	2.6.5.12 <b>ANLR panel</b> Span
<b>CALCulate:TRANSform:FREQUENCY:RESolution?</b>	<b>&lt;nu&gt;</b> Query only		Queries the frequency resolution of FFT, depending on CENTER and SPAN. The response is <b>&lt;nu&gt;</b> in Hz.	2.6.5.12 <b>ANLR panel</b> Resolution

Command	Parameter	Basic unit	Meaning	Section
<b>CALCulate:TRANSform:FREQUENCY:MTIME?</b>	<nu> Query only		Queries the measurement time of FFT, depending on FFT size. The response is <nu> in s.	2.6.5.12 <b>ANLR panel</b> Meas Time
<b>CALCulate:TRANSform:FREQUENCY:WINDOW</b>	RECTangular HANNing BLACKman_harris RIF1 RIF2 RIF3 HAMMING FLATtop KAISer		<ul style="list-style-type: none"> <li>→ Fast and frequency-accurate</li> <li>→ High spectral resolution, wide, bell-shaped curve</li> <li>→ Steep slope of bell lobe</li> <li>→ Excellent suppression of distant interference</li> <li>→ Excellent suppression of distant interference</li> <li>→ Excellent suppression of distant interference</li> <li>→ Implemented for the sake of completeness</li> <li>→ Amplitude read from graphic diagram</li> <li>→ Characteristics determined by <math>\beta</math> factor</li> </ul>	2.6.5.12 <b>ANLR panel</b> Window → RECTANG... → HANN → BLACKMAN H → RIFE VINC 1 → RIFE VINC 2 → RIFE VINC 3 → HAMMING → FLAT TOP → KAISER
<b>CALCulate:TRANSform:FREQUENCY:WINDOW:BETAfact</b> or	<n> = 1 to 20	keine Einheit	$\beta$ factor for KAISer window	2.6.5.12 <b>ANLR panel</b> $\beta$ -Factor
<b>SENSe:VOLTage:EQUALize[:STATe]</b>	ON OFF		<p>Activation/deactivation of an equalizer table consisting of frequency information and associated voltage gain factors.</p> <ul style="list-style-type: none"> <li>→ The equalizer is switched on. The command that follows is accepted.</li> <li>→ The equalizer is switched off; the FFT spectrum remains unchanged.</li> </ul>	2.6.5.12 <b>ANL Panel</b> Equalizer → ON → OFF
<b>MMEMory:LOAD:LIST SENSE,</b>	'filename'		<p>Command for entering the name of the equalizer file.</p> <p>Only permissible with SENS:VOLT:EQU ON</p>	2.6.5.12 <b>ANL Panel</b> Equal. file

## 3.10.2.5.13 Filter Simulation

Command	Parameter	Basic unit-	Meaning	Section
<b>SENSe[1]:FUNCTION</b>	'FILTer <sup>sim</sup> '		→ Display of sum frequency response of the filter to be selected with SENS:FILT... on the UPL display, eg SENS:FILT:AWE ON SENS:FILT2:UFIL5 ON SENS:FUNC 'FILT' IEC LAD 20 IEC GTL	2.6.5.13 ANLR panel Function → FILTER SIM.
<b>SENSe[1]:VOLTage POWer]:UNIT[1 2]</b>	<b>PCT</b> <b>DB</b> see 3.10.4 Units for IEC Measurement Results		Unit of Y axis to be selected with the next command for display of the filter curve.	2.4 ANLR panel Unit Ch1/Ch2
<b>SENSe[1]:FILTER&lt;i&gt;:.....</b>	<i> 1 to 3		See 3.10.3 Selecting the Analyzer Filters	2.7.1 ANLR panel Filter

## 3.10.2.5.14 WAVEFORM

Command	Parameter	Basic unit	Meaning	Section
<b>SENSe[1]:FUNCTION</b>	"WAVeform"		→ Waveform display of applied signal	<b>2.6.5</b> <b>ANLR panel</b> Function → WAVEFORM
<b>SENSe[1]:FUNCTION:DCSuppression</b>	<b>ON</b> <b>OFF</b>		Suppression of DUT DC in the digital analyzer. → DC not considered; corresponds to AC coupling → DC considered in the measurement and displayed; corresponds to DC coupling	<b>2.6.5.1</b> <b>ANLR panel</b> DC Suppres → ON → OFF
<b>SENSe[1]:FUNCTION:MMODE</b>	<b>STANdard</b> <b>COMPressed</b> <b>USAmpl</b>		→ Standard display of samples, max. trace length is 7488 samples. Interpolation can be switched on. → To allow measurements over longer periods of time only peaks are displayed. With command <b>SENSe:WAVeform:COMPression &lt;n&gt;</b> (see below) the number of peak-weighted samples is determined. Available only for instruments A22 and D48. Interpolation cannot be switched on. → Undersampling of signal to record longer periods; the number of samples specified under <b>SENSe:WAVeform:COMPression</b> is arithmetically combined (without detection).	<b>2.6.5.14</b> <b>ANLR panel</b> Meas Mode → STANDARD → COMPRESSED → UNDERSAMP
<b>SENSe[1]:WAVeform:COMPression</b>	<b>&lt;n&gt;</b> 2 to 1024		Number of peak-weighted samples of WAVeform mode <b>SENSe:FUNCTION:MMODE COMPressed</b> .	<b>2.6.5.14</b> <b>ANLR panel</b> Comp Fact
<b>SENSe[1]:VOLTage POWer]:UNIT[1 2]</b>	see 3.10.4 Units for IEC Measurement Results		Display unit for results of DC measurement.	<b>2.4</b> <b>ANLR panel</b> Unit
<b>SENSe[1]:VOLTage POWer]:REFerence</b>	<b>&lt;nu&gt;</b> Analog instrument - 1000 V to 1000 V Digital instrument - 1 kFS to 1 kFS	V FS	Numerical entry of reference value.	<b>2.6.5.1</b> <b>ANLR panel</b> Reference

Command	Parameter	Basic unit	Meaning	Section
<b>SENSe[1]:FILTer</b> <i>.....	<i> 1		See 3.10.3 Selecting the Analyzer Filters  A filter can be selected if <ul style="list-style-type: none"> <li>Option UPL-B29 (Digital Audio 96 kHz) fitted and Base Rate Mode (CONF:DAI BRM)</li> <li>ANLG 22 kHz or DIGITAL instrument (INST2 A22ID48)</li> <li>In DIGITAL analyzer Source Mode AUDIO DATA (SENS:DIG:FEED ADAT)</li> <li>Measurement function WAVEFORM; Meas Mode UNDERSAMPLE (SENS:FUNC:MMOD USAM) .</li> </ul> No filter can be switched on: <ul style="list-style-type: none"> <li>In analyzer ANLG 110kHz</li> <li>Option UPL-B29 (Digital Audio 96 kHz) eingebaut und High Rate Mode (CONF:DAI HRM)</li> </ul>	2.6.5.14 <b>ANLR-Panel</b> Filter
<b>TRIGger:LEVel</b>	<nu> Analog instruments -50V to 50V Digital instrument -1 FS to 1 FS	V FS	Sets the voltage for the trigger threshold.	2.6.5.14 <b>ANLR panel</b> Trig Level
<b>TRIGger:SLOPe</b>	<b>POSitive alias</b> <b>RISing</b> <b>NEGative alias</b> <b>FALLing</b>		Sets the trigger edge.	2.6.5.14 <b>ANLR panel</b> Trig Slope → <b>RISING</b> → <b>FALLING</b>
<b>SENSe[1]:SMOothing:APERture</b>	<b>N1</b> <b>N2</b> <b>N4</b> <b>N8</b> <b>N16</b> <b>N32</b>		Selects the interpolation stages for smoothing the display of the traced waveform.  N1 to N32 = factor 1 to 32	2.6.5.14 <b>ANLR panel</b> Interpol → 1 → 2 → 4 → 8 → 16 → 32

Command	Parameter	Basic unit	Meaning	Section
<b>SENSE[1]:WAVEform:DURATION</b>	<nu> see 2.6.5.14 WAVEFORM	s	Sets the period for which the signal is traced. The max. settable Trace Len is a function of the sampling rate and the interpolation value.	2.6.5.14 <b>ANLR panel</b> Trace Len
<b>TRIGGER:CHANNEL</b>	<b>CH1</b> <b>CH2</b> <b>GENBurst</b>		<p>→ Channel 1 → Channel 2 triggers the measurement for both channels when the trigger level is exceeded (TRIGGER:LEVEL &lt;nu&gt;).</p> <p>→ The generator signal triggers the measurement upon start of the "Burst On" phase, provided that a suitable generator function has been selected. Signal delay times of the devices under test can thus be determined graphically from the waveform display.</p> <p>To be set only for two-channel measurements in instruments A22 and D48.</p>	2.6.5.14 <b>ANLR panel</b> Trig Src → CHAN 1 → CHAN 2 → GEN BURST

## 3.10.2.5.15 Coherence Measurement and Transfer Function

Command	Parameter	Basic unit	Meaning	Section
<b>SENSe[1]:FUNCTION</b>	'COherence'		Coherence and transfer function with built-in option UPL-B6 Conditions: <ul style="list-style-type: none"> <li>Analog instrument 22 kHz (INST2 A22) or digital instrument (INST2 D48) in Meas Mode AUDIO DATA (SENS:DIG:FEED ADAT)</li> <li>Two-channel measurement (INP:SEL CH1A   CH2ICH11   BOTH)</li> </ul>	<b>2.6.5.22</b> <b>ANLR panel</b> FUNCTION → COHERENCE
<b>SENSe[1]:VOLTage POWer :UNIT[1]</b>	PCT DB		Units for result display for transfer function (ratio channel 2/channel 1) of COHERENCE measurement provided TRACE A is selected with DISP:TRAC:FEED 'SENS:DATA'.	<b>2.6.5.22</b> <b>ANLR panel</b> Unit Ch1
<b>SENSe[1]:CHANNEL:DELAY</b>	<nu> -10to10 s	s	Interchannel delay Delay compensation of the DUT by entering the time by which channel 1 is to be delayed with respect to channel 2. If channel 2 has a shorter delay than channel 1, this can be compensated for by entering a negative value.  Available only for for two-channel measurements in instruments A22 and D48	<b>2.6.5.22</b> <b>ANLR-Panel</b> Chan Delay
<b>CALCulate:TRANSform:FREQUENCY:FFT</b>	S256 S512 S1K S2K S4K S8K		FFT size → 256 lines → 512 lines → 1024 lines → 2048 lines → 4096 lines → 8192 lines	<b>2.6.5.22</b> <b>ANLR panel</b> FFT Size → 256 → 512 → 1024 → 2048 → 4096 → 8192

Command	Parameter	Basic unit	Meaning	Section
<b>CALCulate:TRANSform:FREQUENCY:WINDow</b>	<b>HANNing</b> <b>RECTangular</b> <b>BLACKman_harris</b> <b>RIF1</b> <b>RIF2</b> <b>RIF3</b> <b>HAMMING</b> <b>FLATtop</b> <b>KAISer</b>		<ul style="list-style-type: none"> <li>→ Fast and frequency-accurate</li> <li>→ Selective, wide bell</li> <li>→ Steep bell slopes</li> <li>→ Excellent far-off band attenuation</li> <li>→ Excellent far-off band attenuation</li> <li>→ For reason of completeness</li> <li>→ Amplitude can be read off the graphics display</li> <li>→ Characteristics determinable by <math>\beta</math> factor (subsequent command)</li> </ul>	<b>2.6.5.22</b> <b>ANLR panel</b> Window → HANN → RECTANG... → BLACKMAN H → RIFE VINC 1 → RIFE VINC 2 → RIFE VINC 3 → HAMMING → FLAT TOP → KAISER
<b>CALCulate:TRANSform:FREQUENCY:WINDow: <i>BETA</i>fact</b> Or 1 to 20	<n> 1 to 20		$\beta$ -factor for KAISer window	<b>2.6.5.22</b> <b>ANLR panel</b> $\beta$ factor
<b>CALCulate:TRANSform:FREQUENCY: <i>AVER</i>age</b>	<n> 2 to 2048		Number of averaging procedures to increase the accuracy of the coherence measurement	<b>2.6.5.22</b> <b>ANLR panel</b> Average



## 3.10.2.5.16 Loudspeaker Measurements (RUB &amp; BUZZ)

Command	Parameter	Basic unit	Meaning	Section
<b>SENSe[1]:FUNCTION</b>	'RUBBUZZ'		<p>Loudspeaker measurements only with built-in option UPL-B6</p> <p>Rub&amp;Buzz measurement is available if</p> <ul style="list-style-type: none"> <li>• Option UPL-B6.</li> <li>• Option UPL-B29 (Digital Audio 96 kHz) fitted and Base Rate Mode (CONF:DAI BRM)</li> <li>• Analog instrumente 22 kHz (INST2 A22) both channels.</li> <li>• Analog instrument 110 kHz (INST2 A100) channel 1 (INP:SEL CH1)</li> </ul> <p>No Rub&amp;Buzz measurement available if</p> <ul style="list-style-type: none"> <li>• im DIGITAL-Instrument</li> <li>• Option UPL-B29 (Digital Audio 96 kHz) in High Rate Mode (CONF:DAI HRM).</li> </ul>	<b>2.6.5.23</b> <b>ANLR panel</b> FUNCTION → RUB & BUZZ
<b>SENSe[1]:VOLTage:APERture:MODE</b>	<b>AFASt</b> <b>AUTO</b> <b>VALue</b> <b>GENTrack</b>		<p>Measurement time of RUB &amp; BUZZ measurement for adapting the measurement speed to the signal frequency.</p> <p>→ Automatic matching of measurement time to signal frequency taking into account the</p> <p>→ signal period.</p> <p>→ Numerical entry of desired measurement time.</p> <p>→ Measurement taking up (at least) one whole generator signal period. If required, the generator frequency can be adapted to the analyzer sample rate. To increase the measurement time in the case of high frequencies, the measurement time is exceeded to several periods. This mode guarantees <b>maximum accuracy</b> at a <b>minimum measurement time</b> and <b>should be given preference.</b></p>	<b>2.6.5.23</b> <b>ANLR panel</b> Meas Time → AUTO FAST → AUTO → VALUE: → GEN TRACK
<b>SENSe[1]:VOLTage POWerj:UNIT[1 2]</b>	<b>V   DBV   DBU   ...  </b> <b>DBR</b>		Unit for result display of RUB & BUZZ measurement	<b>2.6.5.23</b> <b>ANLR panel</b> Unit Ch1/CH2

Command	Parameter	Basic unit	Meaning	Section
<b>SENSe[1][j]:VOLTag POWer[j]:REFerence:MODE</b>	<b>VALue</b> <b>CH1StoRe</b> <b>CH2StoRe</b> <b>CH1Meas</b> <b>CH2Meas</b> <b>StORe</b>		<ul style="list-style-type: none"> <li>→ Reference value to be entered with the following command</li> <li>→ With two-channel measurements the current measurement result of channel 1 is stored as reference value.</li> <li>→ With two-channel measurements the current measurement result of channel 2 is stored as reference value.</li> <li>→ Value measured in channel 1 is used as a reference for result display with relative units</li> <li>→ Value measured in channel 2 is used as a reference for result display with relative units.</li> <li>→ With single-channel measurements the current result is stored as reference value.</li> </ul>	<b>2.6.5.23</b> <b>ANLR panel</b> Reference
<b>SENSe[1][j]:VOLTag POWer[j]:REFerence</b>	<b>&lt;nu&gt;</b> Analog instrument 100 pV to 1000 V		Numerical entry of reference value with command <b>SENS:REF:MODE VAL</b>	<b>2.6.5.23</b> <b>ANLR panel</b> Reference
<b>SENSe[1][j]:FREQUency:MODE</b>	<b>FIXed   CW</b> <b>GENTrack</b>		<p>Determination of highpass filter type</p> <ul style="list-style-type: none"> <li>→ A fixed highpass filter is used; the numeric value of the passband frequency is entered with the subsequent command <b>SENS:FREQ &lt;nu&gt;</b>.</li> <li>→ Generator tracking: A tracking highpass filter is used which should preferably be tuned to about the 5th harmonic of the generator frequency. The multiple by which the passband frequency should be higher than the generator frequency can be entered with the subsequent command <b>SENS:FREQ:FACT &lt;n&gt;</b>. Frequency limits, within which tracking of the filter frequency should be performed, can be selected with commands <b>SENSe[1]:FREQUENCY:LIMit:LOWer</b> and <b>SENSe[1]:FREQUENCY:LIMit:UPPer</b>. When a limit is reached (<b>FrqLim Low</b> or <b>Upp</b>) the filter frequency is held at this frequency. Thus a tracking highpass filter can be created which becomes a fixed-frequency highpass filter below <b>FrqLim Low</b> and/or above <b>FrqLim Upp</b>. If tracking should be performed over the entire frequency range, the frequency limits should be set to the minimum and maximum value.</li> </ul>	<b>2.6.5.23</b> <b>ANLR panel</b> <b>FREQ MODE</b> → <b>FIX</b> → <b>GEN TRACK</b>

Command	Parameter	Basic unit	Meaning	Section
<b>SENSe[1]:FREQuency:FIXed[CW]</b>	<nu> Value range depends on instrument		Entry of numeric passband frequency for the setting SENS:FREQ:MODE FIX	<b>2.6.5.23</b> <b>ANLR panel</b> FREQ MODE → FIX
<b>SENSe:FREQuency:FACTOR</b>	<nu> MLT 2 to 20		Factor by which the passband frequency of the tracking bandpass or highpass filter should be higher than the generator frequency when GENTRACK (SENS:FREQ:MODE GENT) is set.	<b>2.6.5.23</b> <b>ANLR panel</b> FREQ MODE → Factor
<b>SENSe:SWEep:SYNC</b>	<b>NORMAL</b> <b>FAST</b> <b>BLOCK</b>		Permits the speed for 1-dimensional sweeps with the universal generator to be increased: → Normal sweep speed to be used with any kind of sweeps. → Sweep speed increased as from 2nd sweep run. → Further increase of sweep speed as from 2nd sweep. Update of trace is not online but performed (all in one) when the sweep is completed.	<b>2.6.5.23</b> <b>ANLR panel</b> Sweep Mode → NORMAL → FAST → BLOCK
<b>SENSe[1]:FILTer2:.....</b> <b>SENSe[1]:FILTer3:...</b> ↑ <b>The 2 is important!</b>			Two digital filters (number 2! and 3!) can be selected in addition to the standard highpass filter. <b>Use:</b> Lowpass filter for band limiting (particularly in the ANLG 110 kHz instrument), delay filter for extending the settling time, etc., Bandstop to filter out spurious. <b>Note:</b> <i>Like the standard highpass filter, the filter selected here is only active for measurement channel 1.</i>	<b>2.6.5.23</b> <b>ANLR panel</b> Filter
<b>SENSe[1]:FREQuency:LIMit:LOWER</b>	<nu> Value range: ANLG 22 kHz: 10.0 Hz to 21.9 kHz ANLG 110 kHz: 20.0 Hz to 120 kHz		Lower band limit for tracking the highpass filter frequency for command SENS:FREQ:MODE GENT. If the product of generator frequency and factor drops below the value specified here, the passband frequency of the highpass filter is held at this value.	<b>2.6.5.23</b> <b>ANLR panel</b> Frq Lim Low

Command	Parameter	Basic unit	Meaning	Section
<b>SENSe[1]:FREQUENCY:LIMIT:UPPer</b>	<b>&lt;nu&gt;</b> Value range: ANLG 22 kHz: FrqLim Low to 21.9 kHz ANLG 110 kHz: FrqLim Low to 120 kHz		Upper band limit for tracking the highpass filter frequency for command SENS:FREQ:MODE GENT. If the product of generator frequency and factor exceeds the value specified here, the passband frequency of the highpass filter is held at this value.	<b>2.6.5.23</b> <b>ANLR panel</b> Frq Lim Upp
<b>SYSTEM:SPEaker ...</b>			In the 22 kHz analyzer, the (residual) Rub & Buzz signal in channel 1 and the unfiltered signal in channel 2 can be monitored. This is done by selecting SYST:SPE:SOUR FNC1   FNC2 provided the selected channel is also active as a measurement channel.	<b>2.6.5.23</b> <b>ANLR panel</b> SPEAKER

## 3.10.2.5.17 Input Level of Digital Signal (DIG INP AMP)

Command	Parameter	Basic unit	Meaning	Section
<b>SENSe2:FUNCTION</b>	'DIGInpampl'		→ Measurement of digital input amplitude, see 3.10.2.5.20 Available only in Meas Mode COMMON/INP ("SENS:DIG:FEED CINP")	2.6.5.16 <b>ANLR-Panel</b> INPUT DISP → DIG INP AMPL
<b>SENSe2:UNIT[]</b>	V   DBV   DBU   DBM W   DPCTV   DV   VVR PCTVWR   DPCTW DW   PPR   PCTPPR DBR		Unit for result display of digital input amplitude.	2.6.5.16 <b>ANLR-Panel</b> Unit
<b>SENSe2[VOLTage POWer]:REFERENCE:MODE</b>	VALue STORE DIGoutampl		Reference value for result display in relative units provided a referenced unit is selected. → Reference value specified with the following command. → The current measurement result is stored as reference value. → The currently valid and each newly set generator voltage is stored as reference value.	2.6.5.16 <b>ANLR-Panel</b> Reference → VALIE: → STORE → DIG OUT AMP
<b>SENSe2[VOLTage POWer]:REFERENCE</b>	<nu> 100 pV to 1000 V	V	Numerical entry of reference value.	2.6.5.16 <b>ANLR-Panel</b>

## 3.10.2.5.18 Phase Measurement (PHAS TO REF)

Command	Parameter	Basic unit	Meaning	Section
<b>SENSe2:FUNCTION</b> 'PHASeforef'			→ Measurement of phase between digital input and reference input see 3.10.2.5.20 Nur verfügbar im Meas Mode JITTER/PHAS (SENS:DIG:FEED JPH"	<b>2.6.5.17</b> <b>ANLR-Panel</b> INPUT DISP → PHAS TO REF
<b>SENSe2:UNIT</b> []	UI   PCTFRM   DEGFRM NS		Unit for result display of phase.	<b>2.6.5.17</b> <b>ANLR-Panel</b> Unit

## 3.10.2.5.19 PROTOCOL

Command	Parameter	Basic unit	Meaning	Section
<b>SENSe[1]:FUNCTION</b>	"PROTOCOL"		Protocol data of the digital AES/EBU interface are displayed in the graphics window.	<b>2.6.5</b> <b>ANLR panel</b> Function → PROTOCOL

## 3.10.2.5.20 INPUT DISP

Command	Parameter	Basic unit	Meaning	Section
<b>SENSe2:FUNCTION</b>	"OFF" "PEAKvoltage"		<p>→ Input peak measurement off</p> <p>→ Display of input peak value for all analyzers in all measurement modes</p> <p>In the <b>digital analyzer</b> the input signal is sampled with the user-determined sample rate (see <b>2.6.3</b>).</p> <p>In the <b>analog analyzer</b> the input signal is sampled with the following clock rates after input level control: ANLG 22 kHz with 48 kHz, ANLG 110 kHz with 307.2 kHz</p> <p>The input peak measurement mainly serves for level control and shows peak values of the AC-coupled input signal in front of the filters.</p> <p>→ Input RMS measurement for the analog analyzers INST2 A22   A100, and the digital analyzers INST D48 in the measurement mode SENS:DIG:FEED ADAT for measurement functions SENS:FUNC 'THD' 'THDnsnr' 'MDIS' 'DFD' 'FFT'. The input RMS measurement can be displayed in the form of a sweep curve if DISP:TRAC:FEED 'SENS2:DATA' is set in the DISPLAY panel</p> <p>→ Display of frame phase of the signal with jitter between AUDIO and REF input. This measurement can be carried out <b>simultaneously</b> with any measurement function available for the JITTER signal: SENS:FUNC 'RMS' 'RMSS' 'PEAK' 'FFT' 'WAV' 'PROT'</p> <p>→ Display of digital input amplitude at the selected digital input (XLR or BNC). Only with jitter option (UPL-B22) in the measurement mode COMMON/INP. (INST2 D48 mit SENS:DIG:FEED JPH)</p> <p>This measurement can be carried out <b>simultaneously</b> with any measurement function available for the COMMON signal: SENS:FUNC 'RMS' 'RMSS' 'PEAK' 'FFT' 'WAV'</p>	2.6.5.18 <b>ANLR panel</b> INPUT DISP → OFF → PEAK → RMS → PHAS to REF → DIG INP AMP
	"RMS"			
	"PHASetoref"			
	"DIGInpampl"			
<b>SENSe[1]:VOLTag POWERj:UNIT[1 2]</b>	see 3.10.4 Units for IEC Measurement Results		Display units for RMS measurement	2.4 Unit Ch1/CH2

Command	Parameter	Basic unit	Meaning	Section
<b>SENSe2[:VOLTag POWer]:REFerence:MODE</b>	<b>CH1Store</b> <b>CH2Store</b> <b>STORE</b> <b>CH1Meas</b> <b>CH2Meas</b> <b>GENTrack</b> <b>DIGoutamp</b>  <b>VALue</b>		<ul style="list-style-type: none"> <li>→ For a two-channel measurement, the current measurement result of channel 1 is stored as a reference.</li> <li>→ For a two-channel measurement, the current measurement result of channel 2 is stored as a reference.</li> <li>→ The value measured of channel 1 is used as a reference for the results in reference-related units.</li> <li>→ The value measured of channel 2 is used as a reference for the results in reference-related units.</li> <li>→ For a single-channel measurement, the current measurement result is stored as a reference.</li> <li>→ The currently set generator output level is used as a reference.</li> <li>→ The measured value is referenced to the level of the digital signal set in the digital generator (see 2.6.5.18 INPUT) that is to               <ul style="list-style-type: none"> <li>- "Unbal Vpp", with the UNBAL input selected, and to</li> <li>- "Bal Vpp", with the BAL input selected.</li> </ul> </li> <li>Permissible only in the Meas Mode COMMON/INP (SENS:DIG:FEED CINP)               <ul style="list-style-type: none"> <li>with display of digital input amplitude INPUT DISP = DIG INP AMP (SENS2:FUNC 'DIGI')</li> <li>if GENERATOR INSTRUMENT = DIGITAL is set.</li> </ul> </li> <li>→ The reference value is entered using the next command.</li> </ul>	2.6.5.1 <b>ANLR panel</b> Reference → STORE CH1 → STORE CH2 → MEAS CH1 → MEAS CH2 → STORE → GEN TRACK → DIG OUT AMP → VALUE:
<b>SENSe2[:VOLTag POWer]:REFerence</b>	<b>&lt;nu&gt;</b> Analog instrument 1 $\mu$ V to 1000V Digital instrument 0.0 to 1.0 FS	V FS	Numerical entry of reference value.	2.6.5.1 <b>ANLR panel</b> Reference



## 3.10.2.5.21 Frequency Measurement

Command	Parameter	Basic unit	Meaning	Section
<b>SENSe3:FUNCTION</b>	"OFF" "FREQUENCY"		→ Frequency measurement off → Frequency measurement on  The availability of the frequency measurement depends on measurement function and option UPL-B29 (digital audio 96 kHz), see 2.6.1 Selecting the Analyzer	2.6.5.19 <b>ANLR panel</b> FREQ/PHAS → OFF → FREQ
<b>SENSe[1]:FREQUENCY:APERture:MODE</b>	FAST PRECision		Definition of measurement time and precision of the frequency measurement for the measurement functions OFF and RMS. Does not influence the other measurement functions. → The frequency measurement is set to attain optimum speed → The frequency measurement is set to attain optimum precision	<b>2.6.5.19 ANLR-Panel</b> Meas Time → FAST → PRECISION
<b>SENSe3:FREQUENCY:UNIT[1 2]</b>	HZ DZ DPCTHZ  TOCT OCT DEC  F FR		Display units for results of frequency measurement.	2.4 <b>ANLR panel</b> Unit Ch1/Ch2
<b>SENSe3:FREQUENCY:REFerence:MODE</b>	CH1Store CH2Store CH1Meas CH2Meas STORE GENTrack VALue		→ For a two-channel measurement, the current measurement result of channel 1 is stored as a reference. → For a two-channel measurement, the current measurement result of channel 2 is stored as a reference. → The value measured of channel 1 is used as a reference for the results in reference-related units. → The value measured of channel 2 is used as a reference for the results in reference-related units. → For a single-channel measurement, the current measurement result is stored as a reference. → The currently set generator output level is used as a reference. → The reference unit is specified by the next command.	2.6.5.1 <b>ANLR panel</b> Ref Freq → STORE CH1 → STORE CH2 → MEAS CH1 → MEAS CH2 → STORE → GEN TRACK → VALUE:
<b>SENSe3:FREQUENCY:REFerence</b>	<nu> - 1 MHz to 1 MHz	Hz	Numerical entry of reference value.	2.6.5.1 <b>ANLR panel</b> Ref Freq
<b>SENSe3:FREQUENCY:SETTling:....</b>			For settling commands see 3.10.2.5.1 Common Parameters for Analyzer Functions Frequency settling not selectable for SENSe:DIGital:FEED PHASE CINPut	2.3.4.2 <b>ANLR panel</b> Freq Sett1

## 3.10.2.5.22 Combined Frequency, Phase and Group-Delay Measurement

## Combined Frequency and Phase Measurement

Command	Parameter	Basic unit	Meaning	Section
<b>SENSe3:FUNCTION</b>	"OFF" "FQPHase"		→ Combined frequency and phase measurement off. → Combined frequency and phase measurement on.  The availability of the frequency and phase measurement depends on measurement function and option UPL-B29 (digital audio 96 kHz), see 2.6.1 Selecting the Analyzer	2.6.5.19 <b>ANLR panel</b> FREQ/PHASE → OFF → FREQ&PHASE
<b>SENSe3:FREQUENCY:UNIT[1]</b>	HZ DHZ DPCTHZ  TOCT OCT DEC  FFR		Display units for results of frequency measurement.	2.4 <b>ANLR panel</b> Unit Ch1
<b>SENSe3:PHASE:UNIT2</b>	DEGRAD DDEGI DRAD		Display units for results of phase measurement.	2.4 <b>ANLR panel</b> Unit Ch2
<b>SENSe3:FREQUENCY:REfERENCE:MODE</b>	<b>STORE</b> <b>GENTrack</b> <b>VALue</b>		→ The current frequency measurement result is stored as reference value. → The currently set generator frequency is used as a reference. → The reference value is entered using the next command.	2.6.5.1 <b>ANLR panel</b> Ref Freq → STORE → VALUE: → GEN TRACK
<b>SENSe3:FREQUENCY:REfERENCE</b>	<nu> - 1 MHz to 1 MHz	Hz	Numerical entry of reference value.	2.6.5.1 <b>ANLR panel</b> Reference

Command	Parameter	Basic unit	Meaning	Section
<b>SENSe3:PHASe:FORMAT</b>	<i>Positive</i> <i>POSNegative</i> <i>NEGative</i> <i>RAD</i> <i>RADBiPolar</i> <i>RADNeGative</i>		Display format for phase measurement → 0 to 360° → -180° to -180° → -360° to 0° → 0 to 2 $\pi$ → - $\pi$ to + $\pi$ → -2 $\pi$ to 0	2.6.5.19 <b>ANLR panel</b> Format Pha → 0 .. 360° → -180° .. 180° → -360° .. 0° → 0 .. 2 $\pi$ → - $\pi$ .. + $\pi$ → -2 $\pi$ .. 0
<b>SENSe3:PHASe:REFERENCE:MODE</b>	<i>STORE</i> <i>VALue</i>		→ The current phase measurement result is stored as reference value. → The reference value is entered using the next command.	2.6.5.1 <b>ANLR panel</b> Reference → STORE → VALUE:
<b>SENSe3:PHASe:REFERENCE</b>	<nu> -360° to +360°	DEG	Numerical entry of reference value .	2.6.5.1 <b>ANLR panel</b> Reference
<b>SENSe3:FREQUENCY:SETTLing:.....</b>			For settling commands see 3.10.2.5.1 Common Parameters for Analyzer Functions	2.3.4.2 <b>ANLR panel</b> Freq SettI
<b>SENSe3:PHASe:SETTLing:.....</b>			For settling commands see 3.10.2.5.1 Common Parameters for Analyzer Functions	2.3.4.2 <b>ANLR panel</b> Phas SettI

## Combined Frequency and Group-Delay Measurement

Command	Parameter	Basic unit	Meaning	Section
<b>SENSe3:FUNCTION</b>	"OFF" "FQGRouPdelay"		<p>→ Combined frequency and group-delay measurement off</p> <p>→ Combined frequency and group-delay measurement on. With RSM measurements, POST-FFT is automatically switched on as the frequency information is obtained from FFT.</p> <p>The availability of the frequency and group-delay measurement depends on measurement function and option UPL-B29 (digital audio 96 kHz), see 2.6.1 Selecting the Analyzer</p>	2.6.5.19 <b>ANLR panel</b> FREQ/PHASE → FREQ&GRPDEL
<b>SENSe3:FREQuency:UNIT[1]</b>	HZ DHz DPCTHz  TOCT OCT DEC  FFR		Display units for results of frequency measurement	2.4 <b>ANLR panel</b> Unit Ch1
<b>SENSe3:PHASe:UNIT2</b>	S DS DEG RAD		<p>Display units for results of group-delay measurement</p> <p><b>Note:</b> <i>In addition to group delay (in s), phases outside the range <math>\pm 360^\circ</math> can be measured in DEG or RAD when the frequency sweep mode has been selected.</i></p>	2.4 <b>ANLR panel</b> Unit Ch2
<b>SENSe3:FREQuency:REFeRence:MODE</b>	STORe VALue GENTrack		<p>→ The current frequency measurement result is stored as reference value.</p> <p>→ The reference value is entered using the next command.</p> <p>→ The currently set generator frequency is used as a reference value.</p>	2.6.5.1 <b>ANLR panel</b> Ref Freq → STORe → VALue: → GEN TRACK
<b>SENSe3:FREQuency:REFeRence</b>	<nu> -1 MHz to 1 MHz	Hz	Numerical entry of reference value.	2.6.5.1 <b>ANLR panel</b> Ref Freq
<b>SENSe3:PHASe:REFeRence:MODE</b>	STORe VALue		<p>→ The current phase measurement result is stored as reference value.</p> <p>→ The reference value is entered using the next command.</p>	2.6.5.1 <b>ANLR panel</b> Ref Phase → STORe → VALue:

Command	Parameter	Basic unit	Meaning	Section
<b>SENSe3:PHASe:REFerence</b>	<nu> -360 s to +360 s	s	Numerical entry of reference value	2.6.5.1 <b>ANLR panel</b> Ref Phase
<b>SENSe3:FREQUency:SETTling:.....</b>			For settling commands see 3.10.2.5.1 Common Parameters for Analyzer Functions	2.3.4.2 <b>ANLR panel</b> Freq SettI

### 3.10.2.5.23 Sample Rate Measurement

Command	Parameter	Basic unit	Meaning	Section
<b>SENSe3:FUNCTION</b>	'OFF' 'SFREquency'		→ Off → The measured sampling frequency is displayed on the channels switched on Available only for instrument D48	2.6.5.21 <b>ANLR-Panel</b> FREQUENCY → SAMPLE FREQ
<b>SENSe[1]:FREQUency:APERture:MODE</b>	FAST PRECision		Definition of measurement time and precision of the frequency measurement for the measurement functions OFF and RMS. Does not influence the other measurement functions. → The frequency measurement is set to attain optimum speed → The frequency measurement is set to attain optimum precision	<b>2.6.5.19 ANLR-Panel</b> Meas Time → FAST → PRECISION
<b>SENSe3:FREQUency:UNIT[1]</b>	HZ   DHZ   DPCTHZ   TOCT   OCT   DEC   FFR		Selection of the result units for channel 1	2.4 <b>ANLR-Panel</b> Unit Ch1
<b>SENSe3:FREQUency:UNIT2</b>	HZ   DHZ   DPCTHZ   TOCT   OCT   DEC   FFR		Selection of the result units for channel 2.	2.4 <b>ANLR-Panel</b> Unit Ch2

Command	Parameter	Basic unit	Meaning	Section
<b>SENSe3:FREQUENCY:REFerence:MODE</b>	<b>CH1Store</b> <b>CH2Store</b> <b>CH1Meas</b> <b>CH2Mea</b> <b>STORE</b> <b>GENTrack</b> <b>VALue</b>		<ul style="list-style-type: none"> <li>→ For a two-channel measurement, the current measurement result of channel 1 is stored as a reference.</li> <li>→ For a two-channel measurement, the current measurement result of channel 2 is stored as a reference.</li> <li>→ The value measured of channel 1 is used as a reference for the results in reference-related units.</li> <li>→ The value measured of channel 2 is used as a reference for the results in reference-related units.</li> <li>→ For a single-channel measurement, the current measurement result is stored as a reference.</li> <li>→ The currently set generator output level is used as a reference.</li> <li>→ The reference unit is specified by the next command.</li> </ul>	2.6.5.19 <b>ANLR-Panel</b> Ref Freq → STORE CH1 → STORE CH2 → MEAS CH1 → MEAS CH2 → STORE → GEN TRACK → VALUE:
<b>SENSe3:FREQUENCY:REFerence</b>	<nu> -1 MHz to 1 MHz	Hz	Numerical entry of reference value.	2.6.5.1 <b>ANLR-Panel</b> Ref Freq
<b>SENSe3:FREQUENCY:SETTling:...</b>			For settling commands see <b>3.10.2.5.1 Common Parameters for Analyzer Functions</b>	2.3.4.2 <b>ANLR-Panel</b> Freq Settll

## 3.10.2.5.24 Terzanalyse

Command	Parameter	Basic unit	Meaning	Section
<b>SENSe[1]:FUNCTION</b>	'THIRdocf'		<p>The analysis is performed according to standard IEC 1260 of 1995 with level accuracy of class 0 (<math>\pm 1,0</math> dB).</p> <p>Third Analysis measurement is available if</p> <ul style="list-style-type: none"> <li>• Option UPL-B6 (Extended Analysis Functions) or with hardware upgrade UPL-U8 or in model UPL 06G.</li> <li>• Analog instrumente 22 kHz (INST2 A22) both channels</li> <li>• Digital instrument with option UPL-B29 (Digital Audio 96 kHz) in Base Rate Mode (CONF:DAI BRM)</li> </ul> <p>No Third Analysis measurement available if</p> <ul style="list-style-type: none"> <li>• Analyzer 110 kHz</li> <li>• Digital instrument with option UPL-B29 (Digital Audio 96 kHz) in High Rate Mode (CONF:DAI HRM).</li> </ul> <p>For a detailed example see 3.15.19 Readout of Blockdata of Third Octave Measurement</p>	<b>2.6.5.24 ANLR-Panel</b> Function → 1/3 OCTAVE
<b>SENSe[1]:FUNCTION:MCOUNT</b>	<b>T30</b> <b>T32</b>		<p>Defines the number of thirds which can be measured and displayed</p> <p>→ Maximum 30 thirds can be calculated and displayed. The lowest third which can be measured has a rated center frequency of 25 Hz.</p> <p>→ 2 additional low-frequency thirds, i. e., maximum 32 thirds, can be calculated and displayed. The lowest third which can be measured has a nominal center frequency of 16 Hz.</p>	<b>2.6.5.24 ANLR-Panel</b> Line Count → 30 → 32
<b>SENSe[1]:VOLTage:APERTure:MODE</b>	<b>VALue</b>		<p>Measurement Time of third analysis</p> <p>→ The only parameter determining the measurement speed is the measurement time, which is entered with the next command. The measurement time also determines the update rate of the third analysis.</p>	<b>2.6.5.24 ANLR-Panel</b> Meas Time → VALUE:
<b>SENSe[1]:VOLTage:APERTure</b>	<b>&lt;n&gt;</b> 64 ms to 43200s	s	Numerical entry of measurement time of the third analysis.	<b>2.6.5.24 ANLR-Panel</b> Meas Time

Command	Parameter	Basic unit	Meaning	Section
<b>SENSE:VOLTage:INTV:MODE</b>	<b>OFF</b> <b>FOREver</b> <b>SMOoth</b> <b>EDGE</b>		Hold function for the maximum result of each third. Reset by "INIT:CONT ON" → Max-hold function switched off; only the third bars are displayed. → Max-hold function switched on; the markers lie on the maximum values; reset only by starting the measurement with "INIT:CONT ON". → Max-hold function switched on; the markers lie on the maximum values for the "hold time" to be set with the following command (SENSE[1]:VOLTage:INTVtime <n>) and then decay exponentially (time constant 0.5 s). → Max-hold function switched on; the markers remain on the maximum values for the "hold time" to be set with the following command (SENSE[1]:VOLTage:INTVtime <n>) and then go back to the current measurement value for the third.	<b>2.6.5.24</b> <b>ANLR-Panel</b> Max Hold → OFF → FOREVER → SLOW DECAY → FAST DECAY
<b>SENSE[1]:VOLTage:INTVtime</b>	<n> 20 ms to 100 s	s	Setting of the time for which the maximum value of a third is held before the marker returns to the measured value. The selected hold time does not influence the decay time.	<b>2.6.5.24</b> <b>ANLR-Panel</b> Holdtime
<b>SENSE[1]:VOLTage[Power]:UNIT[1 2]</b>	Analog units: V   DBV   DBU   DBM   W   DPCTV   DV   VVR   PCTVVR   DPCTW   DW   PPR   PCTPPR   DBR Digital units: FS   PCTFS   DBFS   DPCT   DBR   LSBS   BITS		Units for the third analysis measurement results	<b>2.4</b> <b>ANLR-Panel</b> Unit Ch1/Ch2



Command	Parameter	Basic unit	Meaning	Section
<b>SENSe[1]:VOLTag POWer REFerence:MODE</b>	<b>CH1Store</b>		→ <b>Dual</b> -channel measurement: Store the current measurement result of channel 1 as reference value.	<b>2.6.5.1 ANLR-Panel</b> Reference → STORE CH1 → STORE CH2 → MEAS CH1 → MEAS CH2 → VALUE:
	<b>CH2Store</b>		→ <b>Dual</b> -channel measurement: Store the current measurement result of channel 2 as reference value.	
	<b>CH1Meas</b>		→ <b>Dual</b> -channel measurement: Each result of level measurement in channel 1 is used as reference value for result output in reference-related units (floating reference value).	
	<b>CH2Meas</b>		→ <b>Dual</b> -channel measurement: Each result of level measurement in channel 2 is used as reference value for result output in reference-related units (floating reference value).	
	<b>STORE</b>		→ With <b>single</b> -channel measurement: Store the current result as reference value	
	<b>VALue</b>		→ Reference value is displayed upon using the following command	
<b>SENSe[1]:VOLTag POWer REFerence</b>	<b>&lt;nu&gt;</b> Analog instruments 100 pV to 1000 V Digital instrument 0.0 to 1.0 FS	V FS	Numeric entry of reference value.	<b>2.6.5.1 ANLR-Panel</b> Reference
	<b>SENSe[1]:FILTer[1] ...</b>		See 3.10.3 Selecting the Analyzer Filters  Only available with option UPL-B29 (Digital Audio 96 kHz) in Base Rate Mode (CONF:DAI BRM). In the high rate mode (CONF:DAI HRM), the measurement functions THIRdoct can be operated without filter.	<b>2.7.1 ANLR-Panel</b> Filter

Command	Parameter	Basic unit	Meaning	Section
<b>SENSe[1]:FREQUENCY:LiMit:LOWer</b>	<b>&lt;nu&gt;</b> ANLG 22 kHz, 32 lines: 14.1 Hz to 21938 Hz 30 lines 22.6 Hz to 21938 Hz DIG 48 kHz, 32 lines: 14.1Hz to fmax 30 lines 22.6 Hz to 21938 Hz fmax depending on the sampling rate but not exceeding 22449 Hz	Hz	Lower band limit for third analysis.	<b>2.6.5.24</b> <b>ANLR-Panel</b> → Frq Lim Low
<b>SENSe[1]:FREQUENCY:LiMit:UPPer</b>	<b>&lt;nu&gt;</b> ANLG 22 kHz: FrqLim Low to 21938 Hz DIGITAL: FrqLim Low to fmax fmax depending on the sampling rate but not exceeding 22449 Hz	Hz	Upper band limit for third analysis.	<b>2.6.5.24</b> <b>ANLR-Panel</b> → Frq Lim Upp

## 3.10.2.5.25 12th Octave Analysis (12th OCTAVE)

Command	Parameter	Basic unit	Meaning	Section
<b>SENSe[1]:FUNCTION</b>	'TWELVthoct'		<p>The 12th octave analysis is a level measurement by means of a special zoom FFT in up to 125 frequency bands simultaneously.</p> <p>The 12th octave analysis is available</p> <ul style="list-style-type: none"> <li>• with UPL-B6 option installed (Extended Analysis Functions)</li> <li>• in the analog instrument 22 kHz (INST2 A22),</li> <li>• in the digital instrument with UPL-B29 option installed (Digital Audio 96 kHz) in base rate mode, only (CONF:DAI BRM)</li> </ul> <p>The 12th octave analysis is <b>not</b> available</p> <ul style="list-style-type: none"> <li>• in the 110-kHz analyzer</li> <li>• in the digital instrument, with UPL-B29 option installed (Digital Audio 96 kHz) in high rate mode (CONF:DAI HRM).</li> </ul>	<b>2.6.5.25</b> <b>ANLR-Panel</b> Function → 12th OCTAVE
<b>SENSe[1]:VOLTage:APERture:MODE</b>	VALUE		<p>→ Numeric entry of the measurement time of the 12th octave analysis The measurement time defines the update rate of the 12th octave analysis For entry of values see next command..</p>	<b>2.6.5.25</b> <b>ANLR-Panel</b> Meas Time → VALUE:
<b>SENSe[1]:VOLTage:APERture</b>	<nu> tmesFFT ... 43200 s tmesFFT = Measurement time for a zoom FFT depending on the lower frequency limit	s	Numeric entry of the measurement time of the 12th octave analysis	<b>2.6.5.25</b> <b>ANLR-Panel</b> Meas Time
<b>SENSe:VOLTage:INTV:MODE</b>	OFF ON		<p>Hold function for the maximum values of the individual thirds. axhold function switched off, the bars of the frequency bands are displayed, only. → Maxhold function switched on, the markers lie on the highest values; reset via "INIT:CONT ON".</p>	<b>2.6.5.25</b> <b>ANLR-Panel</b> Max Hold → OFF → ON

Command	Parameter	Basic unit	Meaning	Section
<b>SENSe[1]:VOLTag[Power]:UNIT[1 2]</b>	Analog units: V   DBV   DBU   DBM   W   DPCTV   DV   VVR   PCTVWR   DPCTW   DW   PPR   PCTPPR   DBR Digital units: FS   PCTFS   DBFS   DPCT   DBR   LSBS   BITS		Result display units of the 12th octave analysis.	2.4 <b>ANLR-Panel</b> Unit Ch1/Ch2
<b>SENSe[1]:VOLTag[Power]:REference:MODE</b>	<b>CH1Store</b> <b>CH2Store</b> <b>CH1Meas</b> <b>CH2Meas</b> <b>STORE</b> <b>VALue</b>		→ <b>Dual</b> -channel measurement: Store the current measurement result of channel 1 as reference value. → <b>Dual</b> -channel measurement: Store the current measurement result of channel 2 as reference value. → <b>Dual</b> -channel measurement: Each result of level measurement in channel 1 is used as reference value for result output in reference-related units (floating reference value). → <b>Dual</b> -channel measurement: Each result of level measurement in channel 2 is used as reference value for result output in reference-related units (floating reference value). → <b>Single</b> -channel measurement: Store the current result as reference value → Reference value is displayed upon using the following command	2.6.5.1 <b>ANLR-Panel</b> Reference → STORE CH1 → STORE CH2 → MEAS CH1 → MEAS CH2 → STORE → VALUE:
<b>SENSe[1]:VOLTag[Power]:REference</b>	<nu> Analog instruments 100 pV to 1000 V Digital instrument 0.0 to 1.0 FS	V FS	Numeric entry of reference value.	2.6.5.1 <b>ANLR-Panel</b> Reference
<b>SENSe[1]:FILTER[1] ...</b>			See 3.10.3 Available only with option UPL-B29 installed (Digital Audio 96 kHz) in base rate mode (CONF:DAI BRM). In the high rate mode (CONF:DAI HRM), the 12th octave function can be operated without filter, only.	2.7.1 <b>ANLR-Panel</b> Filter

Command	Parameter	Basic unit	Meaning	Section
<b>SENSe[1]:FREQUENCY:LiMit:LOWer</b>	<b>&lt;nu&gt;</b> ANLG 22 kHz: 15.4 Hz to 20586 Hz DIG 48 kHz: 15.4 Hz to fmax fmax depending on the sampling rate but not exceeding 20586 Hz	Hz	Lower band limit for the 12th octave analysis.	<b>2.6.5.25</b> <b>ANLR-Panel</b> → Frq Lim Low
<b>SENSe[1]:FREQUENCY:LiMit:UPPer</b>	<b>&lt;nu&gt;</b> ANLG 22 kHz: FrqLim Low to 20586 Hz DIGITAL: FrqLim Low to fmax fmax depending on the sampling rate but not exceeding 20586 Hz	Hz	Upper band limit for the 12th octave analysis.	<b>2.6.5.25</b> <b>ANLR-Panel</b> → Frq Lim Upp

3.10.3 Selection of Analyzer Filter

Command	Parameter	Basic unit	Meaning	Section
<b>SENSe[1]:FILTeR&lt;i&gt;</b>	<p>&lt;i&gt;* = 1 to 3  <b>OFF</b>                      Query returns name of the filter switched on:                      UFIL1                      :                      UFIL9                      AWE                      CMES                      CCIT                      CCIR                      CCIU                      DEMP5015                      DEMP50                      DEMP75                      DEMP17                      WRUM                      URUM                      DCN                      CARM                      IECT                      JITT</p>		<p>Switches off the filter in the analyzer measurement functions.</p> <p>Measurement functions -----                      Number of possible filters                      RMS 3                      RMS SELECT 1                      PEAK 3 (*)                      QPK 1 (*)                      THD+N 1                      FFT 3 (*)                      FILTER SIM 3                      WAVEFORM 1 (*)                      RUB&amp;BUZZ 2                      THIRD OCT 1 (*)</p> <p>UPL-B29: For the functions marked (*), no digital filter can be switched on in the high rate mode or analyzer ANLG 110 kHz.</p>	2.7.1 <b>FILTER</b> panel Filter
<b>SENSe[1]:FILTeR&lt;i&gt;</b>	<p>&lt;i&gt;* = 1 to 3  <b>OFF</b></p>		<p>Switches off the filter in the analyzer measurement functions RMS, PEAK, QPE or THDN.</p>	2.7.1 <b>FILTER</b> panel Filter
<b>SENSe[1]:FILTeR&lt;i&gt;:UFILteR1... UFILteR9[:STATe]</b>	<p>&lt;i&gt;* = 1 to 3  <b>ON/OFF</b></p>		<p>A HPASs, LPASs, BPASs, BStOp, NOTCh, TERZ, OCTav or FILE filter with freely selectable parameters (see SENSe:FILTeR&lt;n&gt;:HPASs LPASs ... and subsequent commands) can be assigned to each of the 9 user filters (UFILteR).                      When a filter is switched ON the previously active filter is automatically switched OFF.</p>	2.7.1 <b>FILTER</b> panel Filter

Command	Parameter	Basic unit	Meaning	Section
<b>SENSe[1]:FILTeR&lt;i&gt;:CCITt[i]:STATe</b>	<i>*) 1 to 3 <b>ON/OFF</b>		For psophometric measurements When a filter is switched ON the previously active filter is automatically switched OFF.	2.7.1 <b>FILTER panel</b> Filter → CCITT
<b>SENSe[1]:FILTeR&lt;i&gt;:CCIUweight[i]:STATe</b>	<i>*) 1 to 3 <b>ON/OFF</b>		Bandpass filter 20 Hz to 20 kHz When a filter is switched ON the previously active filter is automatically switched OFF.	2.7.1 <b>FILTER panel</b> Filter → CCIR unwtd
<b>SENSe[1]:FILTeR&lt;i&gt;:CCIRweight[i]:STATe</b>	<i>*) 1 to 3 <b>ON/OFF</b>		For RFI voltage measurements When a filter is switched ON the previously active filter is automatically switched OFF.	2.7.1 <b>FILTER panel</b> Filter → CCIR wrd
<b>SENSe[1]:FILTeR&lt;i&gt;:AWEighting[i]:STATe</b>	<i>*) 1 to 3 <b>ON/OFF</b>		For RFI voltage measurements When a filter is switched ON the previously active filter is automatically switched OFF.	2.7.1 <b>FILTER panel</b> Filter → A Weighting
<b>SENSe[1]:FILTeR&lt;i&gt;:CMESsage[:STATe]</b>	<i>*) 1 to 3 <b>ON/OFF</b>		For transmission measurements When a filter is switched ON the previously active filter is automatically switched OFF.	2.7.1 <b>FILTER panel</b> Filter → C MESSAGE
<b>SENSe[1]:FILTeR&lt;i&gt;:DEMPHasis50[:STATe]</b>	<i>*) 1 to 3 <b>ON/OFF</b>		For unweighted and weighted noise measurements When a filter is switched ON the previously active filter is automatically switched OFF.	2.7.1 <b>FILTER panel</b> Filter → DEEMPH 50
<b>SENSe[1]:FILTeR&lt;i&gt;:DEMPHasis75[:STATe]</b>	<i>*) 1 to 3 <b>ON/OFF</b>		For unweighted and weighted noise measurements When a filter is switched ON the previously active filter is automatically switched OFF.	2.7.1 <b>FILTER panel</b> Filter → DEEMPH 75

Command	Parameter	Basic unit	Meaning	Section
<b>SENSe[1]:FILTer&lt;i&gt;:DEMPhasis17[:STATe]</b>	<i>*</i> 1 to 3 <b>ON OFF</b>		For unweighted and weighted noise measurements When a filter is switched ON the previously active filter is automatically switched OFF.	2.7.1 <b>FILTER panel</b> Filter → DEEMPH J.17
<b>SENSe[1]:FILTer&lt;i&gt;:DEMPhasis5015[:STATe]</b>	<i>*</i> 1 to 3 <b>ON OFF</b>		For unweighted and weighted noise measurements When a filter is switched ON the previously active filter is automatically switched OFF.	2.7.1 <b>FILTER panel</b> Filter → DEEM 50/15
<b>SENSe[1]:FILTer&lt;i&gt;:WRUMble[:STATe]</b>	<i>*</i> 1 to 3 <b>ON OFF</b>		Weighted noise measurement for testing tape recorders When a filter is switched ON the previously active filter is automatically switched OFF.	2.7.1 <b>FILTER panel</b> Filter → RUMBLE wtd
<b>SENSe[1]:FILTer&lt;i&gt;:URUMble[:STATe]</b>	<i>*</i> 1 to 3 <b>ON OFF</b>		Unweighted noise measurement for testing tape recorders When a filter is switched ON the previously active filter is automatically switched OFF.	2.7.1 <b>FILTER panel</b> Filter → RUMBLE unw
<b>SENSe[1]:FILTer&lt;i&gt;:DCNoise[:STATe]</b>	<i>*</i> 1 to 3 <b>ON OFF</b>		Highpass filter for measuring the DC noise When a filter is switched ON the previously active filter is automatically switched OFF.	2.7.1 <b>FILTER panel</b> Filter → DC NOISE HP
<b>SENSe[1]:FILTer&lt;i&gt;:CARM[:STATe]</b>	<i>*</i> 1 to 3 <b>ON OFF</b>		Filter for weighted noise measurements in line with older regulations. When a filter is switched ON the previously active filter is automatically switched OFF.	2.7.1 <b>FILTER panel</b> Filter → CCIR ARM
<b>SENSe[1]:FILTer&lt;i&gt;:JITTer[:STATe]</b>	<i>*</i> = 1 to 4 <b>ON   OFF</b>		Weighting of jitter transmission function	2.7.1 <b>FILTER panel</b> Filter → JITTER wtd



Command	Parameter	Basic unit	Meaning	Section
<b>SENSe[1]:FILTer&lt;i&gt;:IECTuner[:STATe]</b>	<i>* 1 to 4 ON/OFF		Filter for tuner measurements to DIN/IEC 315	2.7.1 <b>FILTER panel</b> Filter → IEC Tuner
<b>SENSe[1]:UFILTer&lt;i&gt;:HPASS[:STATe]</b>	<i> 1 to 9 ON		Highpass When a filter is switched ON the previously active filter is automatically switched OFF.	2.7.2 <b>FILTER panel</b> FILTER 01 to 09
<b>SENSe[1]:UFILTer&lt;i&gt;:LPASS[:STATe]</b>	<i> 1 to 9 ON		Lowpass When a filter is switched ON the previously active filter is automatically switched OFF.	2.7.2 <b>FILTER panel</b> FILTER 01 to 09
<b>SENSe[1]:UFILTer&lt;i&gt;:BPASS[:STATe]</b>	<i> 1 to 9 ON		Bandpass When a filter is switched ON the previously active filter is automatically switched OFF.	2.7.2 <b>FILTER panel</b> FILTER 01 to 09
<b>SENSe[1]:UFILTer&lt;i&gt;:BSTOp[:STATe]</b>	<i> = 1 to 9 ON		Bandpass When a filter is switched ON the previously active filter is automatically switched OFF.	2.7.2 <b>FILTER panel</b> FILTER 01 to 09
<b>SENSe[1]:UFILTer&lt;i&gt;:NOTCh[:STATe]</b>	<i> 1 to 9 ON		Notch filter When a filter is switched ON the previously active filter is automatically switched OFF.	2.7.2 <b>FILTER panel</b> FILTER 01 to 09

\*) <i> stands for the filter of analyzer measurement functions RMS, PEAK, QPE and THDN, which has been assigned the specified filter function.

Example:

```
" SENS: FUNC ' RMS ' "
" SENS: FILT1:DEMP5015 ON"
" SENS: FILT3:CCIT ON"
```

causes the following setting in the ANALYZER panel in the RMS & S/N measurement function

• Notch (Gain)	OFF	
• Filter	DEEM 50/15	i = 1
• Filter	OFF	i = 2
• Filter	CCITT	i = 3
• Func Sett1	OFF	

Command	Parameter	Basic unit	Meaning	Section
<b>SENSe[1]:UFILter&lt;i&gt;:&lt;/i&gt;TOCTave[STATE]</b>	<i>1 to 9</i> <b>ON</b>		Third-octave filter (Third Octave) When a filter is switched ON the previously active filter is automatically switched OFF.	2.7.2 <b>FILTER panel</b> FILTER 01 to 09
<b>SENSe[1]:UFILter&lt;i&gt;:&lt;/i&gt;OCTave[STATE]</b>	<i>1 to 9</i> <b>ON</b>		Octave filter When a filter is switched ON the previously active filter is automatically switched OFF.	2.7.2 <b>FILTER panel</b> FILTER 01 to 09
<b>SENSe[1]:UFILter&lt;i&gt;:&lt;/i&gt;FILE[STATE]</b>	<i>1 to 9</i> <b>ON</b>		User-defined filter When a filter is switched ON the previously active filter is automatically switched OFF.	2.7.2 <b>FILTER panel</b> FILTER 01 to 09
<b>SENSe:UFILter[1...9]:DEGREE</b>	<b>N4</b> <b>N8</b>		Selection of order for highpass and lowpass filters → Order 4 → Order 8	<b>2.7.2</b> <b>FILTER panel</b> Degree → 4 → 8
<b>SENSe[1]:UFILter&lt;i&gt;:&lt;/i&gt;PASSb</b>	<i>1 to 9</i> <b>&lt;nu&gt; = LL*</b> For MB limit see 2.6.1 Selecting the Analyzer	Hz	Passband of HPASs and LPASs	2.7.2.2 <b>FILTER panel</b> FILTER 01 to 09 → Passband
<b>SENSe[1]:UFILter&lt;i&gt;:&lt;/i&gt;STOPb?</b>	<i>1 to 9</i> Query only		Queries the stopband of HPASs and LPASs	2.7.2.2 <b>FILTER panel</b> FILTER 01 to 09 → Stopband
<b>SENSe[1]:UFILter&lt;i&gt;:&lt;/i&gt;PASSb:LOWER</b>	<i>1 to 9</i> <b>&lt;nu&gt; = LL*</b> For MB limit see 2.6.5.1 Common Parameters of Analyzer Functions	Hz	Lower passband of BPASs and BSTOp	2.7.2.3 <b>FILTER panel</b> FILTER 01 to 09 → Passb low

Command	Parameter	Basic unit	Meaning	Section
<b>SENSe[1]:UFILter&lt;i&gt;:&lt;i&gt;PASSb:UPPER</b>	<i> = 1 to 9 <nu> = LL*) For MB limit see 2.6.1 Selecting the Analyzer	Hz	Upper passband of BPASs and BSTOp	2.7.2.3 <b>FILTER panel</b> FILTER 01 to 09 → Passb upp
<b>SENSe[1]:UFILter&lt;i&gt;:STOPb:LOWER?</b>	<i> 1 to 9 Query only		Queries the lower stopband of BPASs and BSTOp	2.7.2.3 <b>FILTER panel</b> FILTER 01 to 09 → Stopb low
<b>SENSe[1]:UFILter&lt;i&gt;:STOPb:UPPER?</b>	<i> 1 to 9 Query only		Queries the upper stopband of BPASs and BSTOp	2.7.2.3 <b>FILTER panel</b> FILTER 01 to 09 → Stopb upp
<b>SENSe[1]:UFILter&lt;i&gt;:CENTER</b>	<i> = 1 to 9 <nu> = LL*) For MB limit see 2.6.1 Selecting the Analyzer	Hz	Center frequency of NOTCh, TOCT OCTAV	2.7.2.4 2.7.2.5 <b>FILTER panel</b> FILTER 01 to 09 → Center Frq
<b>SENSe[1]:UFILter&lt;i&gt;:WIDTH</b>	<i> = 1 to 9 <nu> = LL*) For MB limit see 2.6.1 Selecting the Analyzer	Hz	Center frequency of NOTCh, TOCT OCTAV	2.7.2.4 and 2.7.2.5 <b>FILTER panel</b> FILTER 01 to 09 → Width
<b>SENSe[1]:UFILter&lt;i&gt;:ATTenuation</b>	<i> 1 to 9 <nu> 3 to 120 dB	dB	Attenuation of all filters except FILE Def. The value may be corrected in the UPL and queried.	2.7.2.1 <b>FILTER panel</b> FILTER 01 to 09 → Atten
<b>SENSe[1]:UFILter&lt;i&gt;:DELAY</b>	Query only for all filters except for file- defined filters <i> = 1 to 9 <nu> = 0 to 1 s	s	Settling time of FILE-defined filters	2.7.2.7 <b>FILTER panel</b> FILTER 01 to 09 → Delay

Command	Parameter	Basic unit	Meaning	Section
<b>SENSe[1]:UFILter&lt;i&gt;&lt;i&gt;:DELAY?</b>	<i> 1 to 9 Query only		Queries the settling time of filters HPASSs, LPASSs, BPASS, BSTOP, NOTCh, TOCT OCTav	2.7.2.1 <b>FILTER panel</b> FILTER 01 to 09 → Delay
<b>SENSe[1]:UFILter&lt;i&gt;&lt;i&gt;:FILE</b>	"filename" <i> 1 to 9		Path and file name of file-defined filter data e.g. "C:\UPL\USER\MYFILT.ZPZ"	2.7.2.7 <b>FILTER panel</b> FILTER 01 to 09 → Filename

\*) LL = Lower limit value for instruments

22: 24 Hz

A110: 171 Hz

D48: Sample Freq\*Oversamp/2000 (see 2.6.3 Configuration of the Digital Analyzer)



3.10.4 Units for IEC/IEEE Measurement Results

Command	Parameter	Meaning	Section
SENSE[1 2]:VOLTagelPOWVer]:UNIT[1 2]	<b>V</b> <i>MV</i> (only for SENS[1...]) <i>UV</i> (only for SENS[1...]) <b>DBV</b> <b>DBU</b> <b>W</b> <b>DBM</b>  <b>DV</b> <b>DPCTV</b> <b>VVR</b> <b>PCTVVR</b> <b>DW</b> <b>DPCTW</b> <b>PPR</b> <b>PCTPPR</b> <b>DBR</b>	Absolute units for analog level measurement results Absolute units for analog level measurement results Relative units for intermodulation measurements and W&F	2.4 ANLR panel Unit Ch1/Ch2
	<b>DB</b> (only for SENS[1...]) <b>PCT</b> (only for SENS[1...])  <b>FS</b> <b>LSBS</b> <b>DBFS</b> <b>BITS</b>  <b>DPCT</b> <b>PCTFS</b>  <b>UI</b> <b>NS</b>	Relative units for intermodulation measurements and W&F Absolute units for digital phase measurements Relative units for digital level measurements Absolute units for digital jitter and phase measurements	

Command	Parameter	Meaning	Section
<b>SENSe[1 2]:VOLTag POWVer]:UNIT[1 2]</b>	<b>PPMUJ</b> <b>DBUI</b>	} Absolute units for digital jitter measurements } Relative units for digital jitter measurements } Absolute units for digital phase measurement results } Absolute and relative units for frequency readout } Absolute and relative units for phase readout In addition to group delay (in s), phases outside the range $\pm 360^\circ$ can be measured in DEG or RAD $\Delta^\circ$ $\Delta$ RAD s (for group delay) $\Delta$ s (for group delay)	2.4 <b>ANLR panel</b> Unit Ch1/Ch2
	<b>UIR</b> <b>PCTUI</b>		
	<b>PCTFRM</b> (only for SENS2..) <b>DEGFRM</b> (only for SENS2..)		
<b>SENSe3:FREQUENCY:UNIT[1 2]</b>	<b>HZ</b> <b>DHZ</b> <b>DPCTHZ</b> <b>TERZ</b> <b>OCT</b> <b>DEC</b> <b>FFR</b>	Absolute and relative units for frequency readout Hz $\Delta$ Hz $\Delta\%$ Hz Terz Oct Dec f/fr	2.4 <b>ANLR panel</b> Unit Ch1/Ch2
	<b>SENSe3:PHASE:UNIT</b>	Absolute and relative units for phase readout $^\circ$ In addition to group delay (in s), phases outside the range $\pm 360^\circ$ can be measured in DEG or RAD $\Delta^\circ$ $\Delta$ RAD s (for group delay) $\Delta$ s (for group delay)	2.4 <b>ANLR panel</b> Unit Ch1/Ch2

## Display units selectable for measurement results:

Example:

## Display units selectable for measurement results

SENSE[1]:VOLTage|POWER|UNIT[1|2]:

Instrument	Measurement function	Selectable display units
"INST2 A22   A110" "INST2 A22   A110" "INST2 A22" "INST2 A22" "INST2 A22   A110" "INST2 A22   A110"	"SENS:FUNC 'RMS'  'RMSS'  'PEAK'  'QPE'  'DC'  'FFT'"	"SENS:UNIT[1 2] V   DBV   DBU   DBM   W   DPCTV   DV   VVR   PCTVVR   DPCTW   DW   PPR   PCTPPR   DBR"
"INST2 A22   A110"	"SENS:FUNC 'THDN'" and "SENS:FUNC:MMOD LNOI   NOIS "	
"INST2 A22   A110"	"SENS:FUNC 'WAV'" and "SENS:FUNC:MMOD COMP"	
"INST2 A22   A110"	"SENS:FUNC 'THD'   'MDIS'   'DFD' "	"SENS:UNIT[1 2] DB   PCT"
"INST2 A22   A110"	"SENS:FUNC 'THDN'" and "SENS:FUNC:MMOD THDN   NOIS"	
"INST2 A22"	"SENS:FUNC 'WAF'"	"SENS:UNIT[1 2] PCT"
"INST2 A22   A110"	"SENS:FUNC 'WAV'" and "SENS:FUNC:MMOD STAN"	"SENS:UNIT[1 2] V   MV   UV   DPCTV   DV   VVR   PCTVVR"
"INST2 A22   A110"	"SENS:FUNC 'THDN'" and "SENS:FUNC:MMOD SNDR"	"SENS:UNIT[1 2] DB"



Instrument	Measurement function	Selectable display units
"INST2 D48" and "SENS:DIG:FEED ADAT"	"SENS:FUNC 'RMSS'   'PEAK'   'QPE' "	"SENS:UNIT[1 2] FS   PCTFS   DBFS   DPCT   DBR   LSBS   BITS"
	"SENS:FUNC 'THDN'" and "SENS:FUNC:MMOD LNOI   NOIS "	
	"SENS:FUNC 'WAV'" and "SENS:FUNC:MMOD COMP"	
	"SENS:FUNC 'THD'   'MDIS'   'DFD' "	"SENS:UNIT[1 2] DB   PCT"
	"SENS:FUNC 'THDN'" and "SENS:FUNC:MMOD THDN   NOIS "	
	"SENS:FUNC 'WAF'"	"SENS:UNIT[1 2] PCT"
"INST2 D48" and "SENS:DIG:FEED JPH"	"SENS:FUNC 'DC'"	"SENS:UNIT[1 2] FS   PCTFS   DPCT   LSBS"
	"SENS:FUNC 'WAV'" and "SENS:FUNC:MMOD STAN"	
	"SENS:FUNC 'THDN'" and "SENS:FUNC:MMOD SNDR"	"SENS:UNIT[1 2] DB"
	"SENS:FUNC 'RMS'   'RMSS'   'PEAK'   'FFT' "	"SENS:UNIT[1 2] UI   PCTUI   PPMUI   NS   UIR   DBR   DBUI"
	"SENS:FUNC 'WAV'" and "SENS:FUNC:MMOD COMP"	
	"SENS:FUNC 'WAV'" and "SENS:FUNC:MMOD STAN"	"SENS:UNIT[1 2] UI   PCTUI   PPMUI   NS   UIR"
"INST2 D48" and "SENS:DIG:FEED CINP"	"SENS:FUNC 'RMS'   'RMSS'   'PEAK'   'FFT' "	"SENS:UNIT[1 2] V   DBV   DBU   DBM   W   DPCTV   DV   VVR   PCTVVR   DPCTW   DW   PPR   PCTPPR   DBR"
	"SENS:FUNC 'WAV'" and "SENS:FUNC:MMOD COMP"	
	"SENS:FUNC 'WAV'" and "SENS:FUNC:MMOD STAN"	"SENS:UNIT[1 2] V   MV   UV   DPCTV   DV   VVR   PCTVVR"

**Display units selectable for input, peak, RMS and phase measurements**  
**SENSE2[VOLTage|POWER]:UNIT[1|2]:**

Instrument	Measurement function	Selectable display units
"INST2 A22   A110"	"SENS2:FUNC 'PEAK'   'RMS'"	"SENS2:UNIT[1 2] V   DBV   DBU   DBM   W   DPCTV   DV   VVR   PCTVVR   DPCTW   DW   PPR   PCTPPR   DBR"
"INST2 D48" and "SENS:DIG:FEED ADAT"	"SENS2:FUNC 'PEAK'"	"SENS2:UNIT[1 2] FS   PCTFS   DBFS   DPCT   DBR   LSBS   BITS"
"INST2 D48" and "SENS:DIG:FEED JPH"	"SENS2:FUNC 'PEAK'"	"SENS2:UNIT[1 2] UI   PCTUI   PPMUI   NS   UIR   DBR   DBU"
"INST2 D48" and "SENS:DIG:FEED JPH"	"SENS2:FUNC 'PHAS'"	"SENS2:UNIT UI   PCTFRM   DEGFRM   NS"
"INST2 D48" and "SENS:DIG:FEED CINP"	"SENS2:FUNC 'PEAK'   'DIGI'"	"SENS2:UNIT[1 2] V   DBV   DBU   DBM   W   DPCTV   DV   VVR   PCTVVR   DPCTW   DW   PPR   PCTPPR   DBR"

**Display units selectable for frequency, phase and group delay measurements**  
**SENSE3:FREQUENCY:UNIT[1|2] and SENSE3:PHASE:UNIT2:**

Instrument	Measurement function	Selectable display units
"INST2 A22   A110   D48"	"SENS3:FUNC 'FREQ'"	"SENS3:FREQ:UNIT[1 2] HZ   DHZ   DPCTHZ   TOCT   OCT   DEC   FFR"
"INST2 A22"	"SENS3:FUNC 'FQPH'"	"SENS3:FREQ:UNIT HZ   DHZ   DPCTHZ   TOCT   OCT   DEC   FFR"
"INST2 A22"	"SENS3:FUNC 'FQGR'"	"SENS3:PHAS:UNIT DEG   RAD   DDEG   DRAD"
"INST2 A22"	"SENS3:FUNC 'FQGR'"	"SENS3:FREQ:UNIT HZ   DHZ   DPCTHZ   TOCT   OCT   DEC   FFR" "SENS3:PHAS:UNIT S   DS"



## 3.10.5 Loading and Storing

## 3.10.5.1 Loading and Storing Instrument Setups

Command	Parameter	Basic unit	Meaning	Section
<b>SYSTEM:INFOtext:STATE</b>	ON OFF		→ During scrolling in the file selection window of the file box the "Info text" for a setup is displayed in the user info line (of minor importance for IEC/IEEE-bus control). → "Info text" is not displayed.	2.9.1.1 <b>FILE panel</b> Info Displ → ON → OFF
<b>MMEMory:LOAD:STATE</b>	0   2   4, "filename" Query: MMEM:.... ... LOAD:STAT? 0 ... LOAD:STAT? 2 ... LOAD:STAT? 4		0: Load current setup with filename extension .SAC 2: Load complete instrument setup with filename extension .SCO. For loading the R&S default setup under C:UPL\SETUP\DEFAULT.SET use command *RST. Switch off the parameter link (see 2.15.8 Transfer of Parameters (Parameter Link Function)) to ensure that the default setup described under annex "A UPL Default Setup" remains unchanged even after an instrument or function change. 4: Display of (4 bit-) PCX pictures on 1:1 scale on the screen of UPL. It is thus possible to view under program control PCX files stored in UPL (eg for demos). As long as a PCX picture is displayed on the screen, UPL is not ready to receive further IEC/IEEE-bus commands. The PCX picture remains on display until the UPL is set to the LOCAL state with the SYST:COMM:GTL command. Subsequently the UPL is ready to receive IEC/IEEE-bus commands. To switch the UPL from LOCAL to REMOTE again, see 3.3 Switchover to Remote Control	2.9.1.1 <b>FILE panel</b> Mode / Filename
<b>MMEMory:STORE:INFOtext</b>	'string'		A comment of max. 39 characters can be entered for a description of the measurement, a DUT, etc. This comment is displayed in the file box when a setup is loaded by scrolling through the file selection window and SYST:INFO:STAT ON has been selected.	2.9.1.1 FILE panel Info Text
<b>MMEMory:STORE:STATE</b>	0 2,"filename" Query: MMEM:STOR:STAT? 0 MMEM:STOR:STAT? 2		0: Store current setup under filename extension .SAC 2: Store complete instrument setup under filename extension .SCO.	2.9.1.1 <b>FILE panel</b> Mode / Filename

Command	Parameter	Basic unit	Meaning	Section
<b>MMEM</b> ory: <b>STORE:STATE:RONLY</b>	<b>ON</b> <b>OFF</b>		→ File is write-protected → File is not write-protected	2.9.1.1 <b>FILE panel</b> Attrib → READ ONLY → READ/WRITE

## 3.10.5.1.1 Loading and Storing Traces and Lists

Command	Parameter	Basic unit	Meaning	Section
<b>MMEMory:STORE:FORMat</b>	<b>BIN</b> <b>ASCII</b> <b>EXPORT</b>		<p>→ Data stored in binary format  → Data stored in ASCII format  → Daten werden im Textformat in Tabellenform ohne Zusatzinformation mit der Dateierweiterung .EXP gespeichert.  Vorteil: Dateien im EXP-Format können von jedem Texteditor oder anderen Programmen problemlos gelesen und weiterverarbeitet werden.  Nachteil: Da die Zusatzinformationen fehlen, können die Dateien vomUPL/UPD nicht mehr eingelesen werden.  Informationen über den Inhalt der Dateien siehe 2.9.1.2 Loading and Storing of Series of Measured Values and Block/List Data und 2.9.1.3 Format of Block/Listen Data.</p>	2.9.1.2 <b>FILE panel</b> Format → REAL → ASCII → EXPORT
<b>MMEMory:STORE:TRACE</b>	<b>TRACE1,"filename"</b> <b>TRACE2,"filename"</b> <b>TR1And2,"filename"</b>  Query: MMEM:STOR:TRAC? TRAC[1 2] MMEM:STOR:TRAC? TR1A		<p>→ Store trace A buffer under "filename"  → Store trace B buffer under "filename"  → Store trace pair under "filename"</p>	2.9.1.2 <b>FILE panel</b> Store → TRACE A → TRACE B → TRACE A+B
<b>MMEMory:STORE:LIST</b>	<b>LIST1,"filename"</b> <b>LIST2,"filename"</b> <b>DWEL1,"filename"</b>  Query: MMEM:STOR:LIST? LIST[1 2] MMEM:STOR:LIST? DWEL		<p>→ Store X-axis list under "filename"  → Store Z-axis list under "filename"  → Store dwell-time list under "filename"</p>	2.9.1.2 <b>FILE panel</b> Store → X-Axis → Z-Axis → DWEL VALUE

## 3.10.5.1.2 Storing Limit Violations (Error Reports)

Command	Parameter	Basic unit	Meaning	Section
<b>MEMORY:STORE:FORMat</b>	<b>BIN</b> <b>ASCII</b>		→ Data stored in binary format → Data stored in ASCII format	2.9.1.2 <b>FILE panel</b> Format → REAL → ASCII
<b>MEMORY:STORE:LIST</b>	<b>ERRORs,"filename"</b> <b>LIMUpper,"filename"</b> <b>LIMLower,"filename"</b>  Query: MMEM:STOR:LIST? ERR MMEM:STOR:LIST? LIMU MMEM:STOR:LIST? LIML		→ Store limit error under "filename" → Store upper tolerance curve under "filename" → Store lower tolerance curve under "filename"	2.9.1.2 <b>FILE panel</b> Store → LIM REPORT → LIM UPPER → LIM LOWER

## 3.10.5.1.3 Storing Equalization Files

Command	Parameter	Basic unit	Meaning	Section
<b>MMEMory:STORE:FORMat</b>	<b>BIN</b> <b>ASCII</b>		→ Data stored in binary format → Data stored in ASCII format	2.9.1.2 <b>FILE panel</b> Format → REAL → ASCII
<b>CALCulate:EQualize:FEED</b>	<b>TRACe1</b> <b>TRACe2</b>		→ Amplitude data read from → Trace buffer A/B	2.9.1.2 <b>FILE panel</b> Volt Source → TRACE A → TRACE B
<b>CALCulate:EQualize:NORMfreq</b>	<b>&lt;nu&gt;</b> $f_{min}$ to $f_{max}$	Hz	Frequency to the level at which is normalized	2.9.1.2 <b>FILE panel</b> Norm Freq
<b>CALCulate:EQualize:INVert</b>	<b>ON</b> <b>OFF</b>		→ Frequency stored in inverted form → Frequency stored without inversion	2.9.1.2 <b>FILE panel</b> Invert 1/n → ON → OFF
<b>MMEMory:STORE:LIST</b>	<b>EQualize,"filename"</b> Query: MMEM:STOR:LIST? EQU		Store equalization file under "filename"	2.9.1.2 <b>FILE panel</b> Store → EQUALIZATN



## 3.10.5.2 Commands for Editing Files and Directories

Command	Parameter	Basic unit	Meaning	Section
<b>MMEMory:DELETE</b>	"filename"		Deletes a file.	2.9.2 <b>FILE panel</b> Delete
<b>MMEMory:CDIRectory</b>	"pathname"		Selects a directory for file operation.	2.9.2 <b>FILE panel</b> Work Dir
<b>MMEMory:COPY</b>	"filename1", "filename2"		Selects the file to be copied. Specifies the name of the target file (with drive and directory, if required) to which a copy should be made.	2.9.2 <b>FILE panel</b> Copy + To

### 3.10.6 Commands for Graphical Representation of Results

In the following, TRACe1 and TRACe2 serve for differentiating between displayed curves (trace A and trace B), bargraphs and result lists.

Command	Parameter	Basic unit	Meaning	Section
<b>DISP</b> lay[:WINDow]:TRACe[:]: <b>OPER</b> ation	<b>CUR</b> veplot <b>LI</b> STalias <b>TL</b> IST <b>ERR</b> ors  <b>BARG</b> raph <b>SP</b> Ectrum  <b>FF</b> Tlist <b>FF</b> TErrors <b>PR</b> OTocol  <b>AUTO</b> protocol alias <b>AUTO</b> protocol		The parameters below determine the form for the graphics display of measurement results. → Line chart in Cartesian coordinates. → List of numeric values. → List of out-of-tolerance values. In this case the limit check function must be active. → Bargraph display in analog form. → Display of FFT or, in the case of THD, DFD or MOD-DIST, in the form of a schematic spectrum display. → FFT data in tabular form. → FFT limit violation data in tabular form. Limit check function must be active. → Protocol data of the digital AES/EBU interface displayed in the graphics window. → Protocol data of the digital AES/EBU interface displayed in the graphics window. Automatic decoding of the channel status bits irrespective of the professional bit value (see 2.10.8 PROTOCOL Analysis).	<b>2.10</b> <b>DISP</b> panel <b>OPER</b> ATION → <b>CUR</b> VE PLOT 2.10.2 → <b>SW</b> EEP LIST 2.10.4 → <b>SWP</b> LIM REP 2.10.4 → <b>BARG</b> raph 2.10.2 → <b>SP</b> ECT LIST 2.10.8 → <b>SPC</b> LIM REP 2.10.6 → <b>PR</b> OTOCOL 2.10 2.10.8 → <b>PR</b> OTO <b>AUTO</b>
<b>DISP</b> lay[:WINDow]:TRACe[:]: <b>MO</b> DE	<b>DE</b> Lete_bef_wr  <b>WA</b> Terfall/ <b>CAS</b> Cade  <b>MA</b> XHold		→ Selects a single trace or a pair of traces. Each new X sweep overwrites the previous trace. → Shifts a single trace (trace pairs not possible) on the Z axis for obtaining a spatial presentation (with FFT-SPECTrum only). → Maximum hold function for FFT SPECTrum for FFT-AVERage = 1.	<b>2.10</b> <b>DISP</b> panel <b>MO</b> de → <b>DEL</b> BEF WR → <b>WA</b> TERFAL → <b>MA</b> X HOLD
<b>DISP</b> lay[:WINDow]:TRACe[:]: <b>COUN</b> t	<n> recorded: 1 to 100 000 stored: max. 17 traces		Specifies the number of single traces and trace pairs to be recorded together and stored. Automatically sets the number of Z values in the case of a Z sweep.	<b>2.10</b> <b>DISP</b> panel Scan Count

Command	Parameter	Basic unit	Meaning	Section
<b>DISP</b> lay[:WINDow]: <b>TRACe</b> [1 2]: <b>FEED</b>	"SENSe1:DATA1" "SENSe1:DATA2" "SENSe2:DATA1" "SENSe2:DATA2" "SENSe3:DATA1" "SENSe3:DATA2"  "HOLD" "FILE" "DFILE" "OFF"		Selects the result to be displayed as TRACe1 (or TRACe2). → Measurement function specified by SENSe1:FUNCTION "<>". Value from channel 2 (CH1). → Measurement function specified by SENSe1:FUNCTION "<>2". Value from channel 2 (CH2). → Result of input RMS measurement of channel 1 (CH1) for THD and THDN functions. → Result of input RMS measurement of channel 2 (CH2) for THD and THDN functions. → Measured value from frequency meter, channel 1 (CH1). → Measured value from frequency meter, channel 2 (CH2) if SENSe3:FUNC FREQ is selected. Measured value from phase meter, channel 2 (CH2) if SENSe3:FUNC FQPH. Measured value from group delay measurement, channel 2 (CH2) if SENSe3:FUNC FQGR is selected → Retains previously displayed values (no collection of new values). → Displays measured values from a file using the command described below. → Loads a trace pair with scale and reference values or reference trace using the command described below. → Switch-off	2.10.1 <b>DISP</b> panel TRACE A/B → FUNC CH1 → FUNC CH2 → INP RMS CH1 → INP RMS CH2 → FREQ CH1 → FREQ CH2 → PHASE → GROUP DEL → HOLD → FILE → DUAL FILE → OFF
<b>MMEM</b> ory: <b>LOAD:TRACe</b>	<b>TRACe</b> [1 2], "filename" " Query: MMEM:LOAD:TRAC? TRAC[1 2]		Loads a trace from a file for display.	2.10.1 <b>DISP</b> panel TRACE A/B → FILE + Filename
<b>TRACe:DATA?</b>	<b>TRACe</b> [1 2] Query only Query: TRAC? TRAC[1 2]		The trace (block data) can be read from the UPL to the controller.	2.10.1 <b>DISP</b> panel
<b>DISP</b> lay[:WINDow]: <b>TRACe</b> [:Y[:SCALE]: <b>UNIT</b>	<U> see 3.10.4 Units for IEC Measurement Results	1)	Determines the units for results displayed in numerical form.	2.10.1 <b>DISP</b> panel Unit

Command	Parameter	Basic unit	Meaning	Section
<b>DISP</b> lay[:WINDow]:TRACe[1 2]:Y[:SCALE]:RLEVel:MO DE	<b>VAL</b> ue <b>MA</b> Ximum <b>CUR</b> Sor[1] <b>CUR</b> Sor 2 <b>FI</b> LE <b>HOLD</b> <b>OT</b> RACe <b>CH1</b> Meas <b>CH2</b> Meas <b>GEN</b> TTrack <b>FI</b> Le <b>REF</b> 997 <b>REF</b> 1000		<p>A reference value is required for all relative units of TRACe1 or TRACe2.</p> <ul style="list-style-type: none"> <li>→ The subsequently entered value is used as a reference.</li> <li>→ Uses the maximum value of the trace once.</li> <li>→ The value pointing to the o-cursor is stored as a reference.</li> <li>→ The value pointing to the *-cursor is stored as a reference.</li> <li>→ Reference for reference-related units is a file indicated by MMEMory:LOAD:TRACe[1 2]REFTrace,"name.TRC".</li> <li>→ The reference-trace memory is no longer filled with new (sweep) values. Stored values are retained.</li> <li>→ Reference for reference-related units is another trace.</li> <li>→ Reference for reference-related units is the value measured in channel 1 or 2 pertaining to the respective reference point (depending on the display measured frequency, function or input result).</li> <li>→ The reference trace is erased and reloaded for each measurement using the respective generator setting.</li> <li>→ When a trace with the associated reference trace (internal reference FILE) is loaded, FILE activates this internal reference file again when another reference has been selected before.</li> <li>→ The value measured at 997 Hz or 1 kHz is taken once as a reference value for a single sweep run. With FFT traces, the nearest bin (actually measured frequency line) is taken, with frequency sweeps interpolation is made between the two neighbouring points. If the X axis is not the frequency axis (for example in the case of level sweeps or waveform traces), an error message is output and the reference value remains unchanged.</li> </ul>	<p>2.10.1 <b>DISP</b> panel Reference → VALUE → MAX → oCURSOR → *CURSOR → FILE → HOLD → OTHER TRACE → MEAS CH1 → MEAS CH2 → GEN TRACK → FILE INTERN → REF 997 Hz → REF 1000 Hz</p>
<b>DISP</b> lay[:WINDow]:TRACe[:Y[:SCALE]:RLEVel	<nu>	1)	Entry of reference value for relative units.	<p>2.10.1 <b>DISP</b> panel Reference → VALUE</p>
<b>MMEM</b> ory:LOAD:TRACe[1 2]	<b>REF</b> Trace,"filename" Query: MMEM:LOAD:TRAC[ 1 2]? REFT		→ File containing the reference-trace data for trace A. Default extension = .TRC	<p>2.10.1 <b>DISP</b> panel Reference → FILE + Reference</p>

Command	Parameter	Basic unit	Meaning	Section
<b>DISP</b> lay[:WINDow]: <b>TRACe</b> 2:Y[:SCALe]: <b>Equal</b>	<b>ON</b> <b>OFF</b>		→ TRACe2 may be displayed on the same axis as TRACe1. In this case no values can be entered for: UNIT, RLEVel, SCALE:AUTO, TOP, BOTTOM and :SPACing for the second axis. → Independent of trace 1.	2.10.1 <b>DISP panel</b> Scale B → EQUAL A → NOT EQUAL A
<b>DISP</b> lay[:WINDow]: <b>TRACe</b> [1 2]:Y[:SCALe]: <b>AUTO</b>	<b>ONCE</b> <b>OFF</b>		→ Uses the minimum and maximum values of the present trace for rescaling the display once. The new scaling data are transferred to and used in DISP:TRAC:Y:TOP <n> and DISP:TRAC:Y:BOTT <n>. → Leaves scaling to the user with the aid of the following two commands.	2.10.1 <b>DISP panel</b> Scale → AUTO ONCE → MANUAL  ONCE mit Softkey F7 (AUTOSCALE) → F7 (A) → F8 (B)
<b>DISP</b> lay[:WINDow]: <b>TRACe</b> [1 2]:Y[:SCALe]: <b>NORMALize:MODE</b>	<b>CURSor</b> [1] (o-Cursor) <b>CURSor</b> 2 (*-Cursor) <b>VALue</b>		With normalize the reference curve can be multiplied so that a specific Y value is obtained at the desired Y position.  → The multiplier is obtained from the measured value at the cursor position divided by the reference value at this position. Thus the new reference corresponds to the value measured at this position (= 0 dB). → Entry of a fixed multiplier using the next command:  Presettings required: DISP:TRAC[1 2]:OPER CURV and DISP:TRAC[1 2]:FEED 'SENS1:DATA1''SENS1:DATA2''HOLD' and DISP:TRAC[1 2]:Y:UNIT VVRPCTV R PPR PCT PPR DBR and DISP:TRAC[1 2]:Y:RLEV:MODE GENT or DISP:TRAC[1 2]:OPER CURV and DISP:TRAC[1 2]:FEED 'SENS3:DATA1''SENS3:DATA2''HOLD' and DISP:TRAC[1 2]:Y:UNIT TOCT OCT DEC FFR and DISP:TRAC[1 2]:Y:RLEV:MODE GENT	2.10.1 <b>DISP panel</b> Normalize → o-Cursor → *-Cursor → VALue

Command	Parameter	Basic unit	Meaning	Section
<b>DISP</b> lay[:WINDow]: <b>TRAC</b> e[1 2]: <b>Y</b> [:SCALe]: <b>NORM</b> alize	<nu> 10 <sup>-12</sup> to 10 <sup>6</sup> or -200 dB to 120 dB	Multi- plier   dB	The specified number is multiplied to obtain the reference value. This allows the reference of a trace to be determined as required.	2.10.1 <b>DISP</b> panel Normalize
<b>DISP</b> lay[:WINDow]: <b>TRAC</b> e[1 2]: <b>Y</b> : <b>SPAC</b> ing	<b>L</b> inear <b>LOG</b> arithmic		→ Linear spacing of Y axes → Logarithmic	2.10.1 <b>DISP</b> panel Spacing → LIN → LOG
<b>DISP</b> lay[:WINDow]: <b>TRAC</b> e[1 2]: <b>Y</b> [:SCALe]: <b>TOP</b>	<nu>	1)	Sets the upper value of the Y axis (of the dependent value) in the case of DISPLAY:TRACE[1 2]:Y:AUTO OFF	2.10.1 <b>DISP</b> panel Top
<b>DISP</b> lay[:WINDow]: <b>TRAC</b> e[1 2]: <b>Y</b> [:SCALe]: <b>BOTTOM</b>	<nu>	1)	Sets the lower value of the Y axis (of the dependent value) in the case of DISPLAY:TRACE[1 2]:Y:AUTO OFF.	2.10.1 <b>DISP</b> panel Bottom
<b>DISP</b> lay[:WINDow]: <b>TRAC</b> e[1 2]: <b>X</b> [:SCALe]: <b>UNIT</b>	<u> see 3.10.4 Units for IEC Measurement Results		Determines the units for the numeric results displayed on the X axis.	2.10.1 <b>DISP</b> panel Unit
<b>DISP</b> lay[:WINDow]: <b>TRAC</b> e[1 2]: <b>X</b> [:SCALe]: <b>RLEVEL</b>	<nu>	2)	Entry of reference value for relative units.	2.10.1 <b>DISP</b> panel Reference
<b>DISP</b> lay[:WINDow]: <b>TRAC</b> e[:] <b>X</b> [:SCALe]: <b>AUTO</b>	<b>ON</b> <b>OFF</b>		→ Uses the minimum and maximum values of the present trace for scaling the X axis (once). → Leaves scaling to the user with the aid of the following two commands.	2.10.1 <b>DISP</b> panel Scale → AUTO → MANUAL or <b>Softkey</b> F7 (AUTOSCALE) → F9 (X)

Command	Parameter	Basic unit	Meaning	Section
<b>DISP</b> lay[:WINDow]: <b>TRACe</b> [:X]: <b>SPAC</b> ing	<b>L</b> inear <b>LOG</b> arithmic		→ Linear spacing of X axis → Logarithmic	2.10.1 <b>DISP</b> panel Spacing → LIN → LOG
<b>DISP</b> lay[:WINDow]: <b>TRACe</b> [:X]: <b>SCALe</b> : <b>LEFT</b>	<nu>	2)	Sets the left-hand value of the X axis (of the independent value) in the case of <b>DISP</b> lay: <b>TRACe</b> :X: <b>AUTO OFF</b> .	2.10.1 <b>DISP</b> panel Left
<b>DISP</b> lay[:WINDow]: <b>TRACe</b> [:X]: <b>SCALe</b> : <b>RIGHT</b>	<nu>	2)	Sets the right-hand value of the X axis (of the independent value) in the case of <b>DISP</b> lay: <b>TRACe</b> :X: <b>AUTO OFF</b> . The lower value of <b>LEFT</b> and <b>RIGHT</b> is used as left-hand value.	2.10.1 <b>DISP</b> panel Right
<b>DISP</b> lay[:WINDow]: <b>TEXT</b> [: <b>DATA</b> ]	"string"		Permits a text to be entered that will be displayed within the trace display in the case of <b>DISP</b> lay: <b>TRACe</b> [12]: <b>OPERATION CURVe</b> plot.	2.10.1 <b>DISP</b> panel <b>COMMENT</b>
<b>DISP</b> lay[:WINDow]: <b>TEXT</b> : <b>LOC</b> ate	<ny>[:<nx>]		Determines the X and Y position of the text. X and Y are the relative distance from the 0 point of the coordinates in % (0 to 100).	2.10.1 <b>DISP</b> panel X Pos, Y Pos
<b>DISP</b> lay[:WINDow]: <b>TRACe</b> [: <b>ACTIVE</b> ]	<b>CUR</b> Sor[12]		Switches the cursors alternately on and off. This only affects the display. <b>CUR</b> Sor1 is marked with o, <b>CUR</b> Sor2 with *.	2.10.2 <b>DISP</b> panel Softkey, 1st level F8
<b>DISP</b> lay[:WINDow]: <b>TRACe</b> [: <b>CUR</b> Sor[1]: <b>MODE</b> ]	<b>N12</b> <b>D12</b> <b>OFF</b>		Parameters used for selecting the cursor function and the type of the displayed numeric cursor values. → Display of measured values A and B and of associated X value. → Display of difference value of A and B at the cursor position and of X value. → The deactivated cursor is no longer displayed.	2.10.2 <b>Softkey</b> F8: selects O- <b>CUR</b> S. F9: (O- <b>CUR</b> SOR) → F6 (A,B) → F7 (A-B) → F11 (ON/OFF)

Command	Parameter	Basic unit	Meaning	Section
<b>DISP</b> lay[:WINDow]: <b>TRACe</b> [: <b>CURSor</b> 2: <b>MODE</b>	<b>M12</b> <b>D12</b> <b>C12</b> <b>HL1</b> <b>HL2</b> <b>HLD1</b> <b>HLD2</b> <b>OFF</b>		<p>→ Display of measured values A and B and of associated X value.</p> <p>→ Display of difference value of A and B at the cursor position and of X value.</p> <p>→ Difference of trace and X values of curves A and B which are marked by the two cursors.</p> <p>→ The *-cursor is switched to horizontal line. Its Y value and intersections with TRACe1 (if any) are displayed.</p> <p>→ Intersections with TRACe2 are displayed.</p> <p>→ The *-cursor is switched to horizontal line. The difference between its Y value and the Y value of the o-cursor are displayed.</p> <p>→ Intersections with TRACe1 are displayed as well.</p> <p>→ Same as with HLD1, but the intersections with TRACe2 are displayed.</p> <p>→ The deactivated cursor is no longer displayed.</p>	2.10.2 <b>Softkey</b> F8 sel. o-cursor F9 sel. *-cursor → F6 (A,B) → F7 (A-B) → F8 (* - O) → F9 (HLINE) → A → F9 (HLINE) → B → F9 (HLINE) → ΔA → F9 (HLINE) → ΔB → F11 (ON/OFF)
<b>DISP</b> lay[:WINDow]: <b>TRACe</b> [: <b>CURSor</b> [1 2]: <b>POSITION</b> . <b>MO</b> <b>DE</b>	<b>MIN1</b> <b>MIN2</b> <b>I MAX1</b> <b>MAX1</b> <b>I MAX2</b> <b>MAX2</b> <b>MARKer1</b> <b>NEXTharm</b> <b>VALue</b>		<p>Changes the position of the specified cursor.</p> <p>→ Sets cursor to the minimum of TRACe1.</p> <p>→ Sets cursor to the maximum of TRACe2.</p> <p>→ Sets cursor to calculated maximum of TRACe1 (with FFT only)</p> <p>→ Sets cursor to maximum of TRACe1.</p> <p>→ Sets cursor to calculated maximum of TRACe2 (with FFT only)</p> <p>→ Sets cursor to maximum of TRACe2.</p> <p>→ Sets cursor to value of 1st marker (FFT only).</p> <p>→ Sets cursor to the next harmonic (FFT only).</p> <p>→ Sets cursor to the value specified with the command below.</p>	2.10.2 <b>Softkey</b> F8 sel. O-CURS or *-CURS → F10 (SET TO) → ---- → ---- → F6 (I MAX A) → F7 (MAX A) → F8 (I MAX B) → F9 (MAX B) → F10 (MARKER) → F11 (NXTHARM)
<b>DISP</b> lay[:WINDow]: <b>TRACe</b> [: <b>CURSor</b> [1 2]: <b>POSITION</b>	<nu>	3)	<p>Sets specified cursor to the value of the X axis if DISP:TRACe[:CURSor[1 2]:POSITION:MODE VALue is set.</p>	2.10.2 not via softkey



Command	Parameter	Basic unit	Meaning	Section
<b>DISP</b> lay[:WINDow]: <b>TRACe</b> [1 2]: <b>CURVe</b>	<b>OFF</b> <b>ON</b>		→ TRACe1: trace A on/off → TRACe2: trace B on/off	2.10.2 <b>Softkey</b> → F6 (CURVE) → F6 (A ON/OFF) → F7 (B ON/OFF)
<b>DISP</b> lay[:WINDow]: <b>TRACe</b> [:]: <b>ZOOM</b>	<n> <b>0</b> <b>1</b> <b>-1</b> <b>2</b> <b>3</b> <b>4</b>		→ Restores the original X axis defined by X AXIS LEFT and RIGHT. → Expands the display on the X axis by the factor 2 (can be repeated). → Reduces the display on the X axis by the factor 2 (repeated actions possible). → Shifts the center of the X axis of the new coordinates to the value of the o-cursors (CURSor1) without expanding the X axis. → The end points of the expanded X axis are determined by the X values of the two cursors → Cancels the last action.	2.10.2 <b>Softkey</b> F10 (ZOOM) → F10 (UNZOOM) → F6 (AT o UP) → F7 (AToDOWN) → F8 (CEN TO o) → F9 (o TO *) → F11 (UNDO)
<b>DISP</b> lay[:WINDow]: <b>TRACe</b> [1 2]: <b>MARKer:MODE</b>	<b>MAXimum</b> <b>CURSOR</b> <b>OFF</b>		Markers for FFT spectrum display → Sets the first marker to the maximum of TRACe1 or TRACe2. → Sets the first marker to the value defined by the o-cursor. TRACe1 or TRACe2 is used. → No markers	2.10.2 <b>Softkey</b> F11 (MARKER) F6 (TRACE A) or F7 (TRACE B). → MAX → CURSOR → VIEW OFF
<b>DISP</b> lay[:WINDow]: <b>TRACe</b> [1 2]: <b>MARKer:HARMONics</b>	<b>ON</b> <b>OFF</b>		→ Sets markers for harmonics (frequency multiples) of MARKer1 (FFT only). Values marked in TRACe1 or TRACe2. → No harmonics markers.	2.10.2 <b>Softkey</b> F11 (MARKER) F6 (TRACE A) or F7 (TRACE B) → F10 (HARM) on/off

Command	Parameter	Basic unit	Meaning	Section
<b>DISP</b> lay[:WINDow]: <b>TRACe</b> [: <b>AUT</b> oScale]			Rescales the X and the TRACe1 axis. When active also the axis of TRACe2.	2.10.2 <b>Softkey</b> F7 (AUTOSCALE) F6 (ALL)
<b>DISP</b> lay[:WINDow]: <b>TRACe</b> [: <b>LABe</b> ]	<b>ON</b> <b>OFF</b>		→ Activates user title and units. → Deactivates user title and units.	2.10.2 <b>DISP panel</b> User Label → ON → OFF
<b>DISP</b> lay[:WINDow]: <b>TRACe</b> : <b>X:LABe</b> ]	"string"		Specification of a string determining a user-definable label (unit and title) for the X axis.	2.10.2 <b>DISP panel</b> Unit/Label
<b>DISP</b> lay[:WINDow]: <b>TRACe</b> [1]: <b>Y:LABe</b> ]	"string"		Specification of a string determining a user-definable label (unit and title) for the Y1 axis.	2.10.2 <b>DISP panel</b> Unit/Label
<b>DISP</b> lay[:WINDow]: <b>TRACe</b> 2: <b>Y:LABe</b> ]	"string"		Specification of a string determining a user-definable label (unit and title) for the Y2 axis.	2.10.2 <b>DISP panel</b> Unit/Label
<b>DISP</b> lay[:WINDow]: <b>TRACe</b> [: <b>INDEX</b> ]	<n> 1 to 17		Selects the nth single trace or curve pair. In the graphics display a circle marks the intersection of the vertical cursor line and the selected trace.	2.9.3.3 <b>Keys</b> PAGE UP / PAGE DOWN

Command	Parameter	Basic unit	Meaning	Section
<b>DISPlay:CONFiguration</b>	<b>P</b> <b>SP</b> <b>AP</b> <b>GP</b> <b>FP</b> <b>DP</b> <b>OP</b> <b>GAT</b> <b>GAO</b> <b>GAD</b> <b>FAT</b> <b>FAO</b> <b>FAD</b> <b>SHON</b> <b>SHOFF</b>		Configuration of screen display after switchover to LOCAL: → Full-screen graphics display (plot) → Status panel and graphics window → Analyzer panel and graphics window → Generator panel and graphics window → File panel and graphics window → Display panel and graphics window → Options panel and graphics window → Generator, analyzer and filter panel → Generator, analyzer and options panel → Generator-, analyzer and display panel → File, analyzer and filter panel → File, analyzer and options panel → File, analyzer and display panel → Show IO graphics on → Show IO graphics off	2.3.1 Keys Ext. UPL keyboard GEN ALT+G ANLR ALT+A FILT ALT+T FILE ALT+F DISP ALT+D GRAPH ALT+R ZOOM ALT+Z SHOW I/O ALT+I OPTIONSALT+O
<b>DISPlay[:WINDow]:TRACe[:CURSor[:DATA1?</b> <b>DISPlay[:WINDow]:TRACe[:CURSor[:DATA2?</b> <b>DISPlay[:WINDow]:TRACe[:CURSor[:DATA3?</b>	Query only		Return the values of the cursor position. Depending on DISPlay:TRACe[:CURSor[1 2]:MODE and DISPlay:TRACe[:CURSor[1 2]:ACTIVE the following values are available: DATA1 DATA2 DATA3 with CURSor1 and CURSor2 ACTIVE N12 A X X B D12 A-B X X - OFF - - - only with CURSor2 ACTIVE: C12 A-oA X-oX B-oB HL1 XAL Y XAR HL2 XBL Y XBR HLD1 XAL A-Y XAR HLD2 XBL B-Y XBR	2.10.2 <b>Display in graphics window</b>

1) Depending on DISPlay:TRACe:FEED and (with SENSE1) of SENSE1:FUNCTION

2) Depending on the sweep selected for generator and analyzer

3) Same units as with DISPlay:TRACe[:X:UNIT permitted.

### 3.10.6.1 Commands for Limit Check

See also Sections 2.10.7 Limit Check, 3.10.9 Commands for Input/Output of Data and 3.10.9 Commands for Input/Output of Data, for the transfer of limit curves and limit check results in the form of block data.

Command	Parameter	Basic unit	Meaning	Section
<b>CALCulate:LIMit:ON</b>	TRACe1 TRACe2 TR1And2		→ TRACe1 or bargraph 1 monitored. → TRACe2 or bargraph 2 monitored. → Both traces (bargraphs) monitored together.	2.10.7 <b>DISP panel</b> Check → TRACE A → TRACE B → TRACE A+B
<b>CALCulate:LIMit:UPPER:STATE</b>	ON OFF		→ Upper limit monitoring switched on. → Upper limit monitoring switched off.	2.10.7 <b>DISP panel</b> LIMIT CHECK Mode → LIM UPPER Mode → OFF
<b>CALCulate:LIMit:UPPER:VALue</b>	<nu>	*)	Specifies a single upper limit value.	2.10.7 <b>DISP panel</b> Lim Upper → VALUE:
<b>MMEMoRY:LOAD:LIST</b>	LIMUpper, "filename"		→ Defines a file containing the upper limit curve.	2.10.7 <b>DISP panel</b> Lim Upper → FILE + filename"

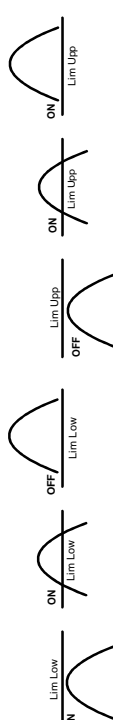
Command	Parameter	Basic unit	Meaning	Section
<b>CALCulate:LiMIt:LOWer:STATE</b>	ON OFF		→ Lower limit monitoring switched on. → Lower limit monitoring switched off.	2.10.7 <b>DISP panel</b> LIMIT CHECK Mode → LIM LOWER Mode → OFF
<b>CALCulate:LiMIt:LOWer:VALue</b>	<nu>	*)	Specifies a single lower limit value.	2.10.7 <b>DISP panel</b> Lim Lower → VALUE:
<b>MMEMory:LOAD:LIST</b>	LIMLower, "filename"		→ Defines a file containing the lower limit curve.	2.10.7 <b>DISP panel</b> Lim Lower → FILE + filename
<b>CALCulate:LiMIt:FAIL?</b>	<n> Query only		Returns ON if Lim Upper values are exceeded or Lim Lower values are not attained, otherwise OFF. 	2.10.7 <b>No manual control</b>

\*) Same units as with DISPLAY:TRACe[1|2]:Y:UNIT permitted.

## 3.10.6.2 PROTOCOL Analysis

Command	Parameter	Basic unit	Meaning	Section
<b>DISP</b> lay: <b>PROT</b> ocol: <b>SEL</b> ect	LChannelstatus RChannelstatus LUserdata RUserdata		Selects the protocol data of the AES/EBU interface to be displayed. → Left channel: status data → Right channel: status data → Left channel: user data → Right channel: user data	2.10.8 <b>DISP</b> panel Source → CHAN STAT L → CHAN STAT R → USER DATA L → USER DATA R
<b>DISP</b> lay: <b>PROT</b> ocol: <b>FOR</b> Mat	BINary HEXadecimal ASCIi FILE		Format selects the interpretation mode for user data. → User data displayed as 0101 sequence. → User data displayed as hexadecimal figures → User data displayed as plain text → Interpretation file for user data loaded with MMEMemory:LOAD:PAU "filename".	2.10.8 <b>DISP</b> panel Format → BIN → HEX → ASCII → FILE DEF
<b>MMEM</b> ory: <b>LOAD:PAU</b>	"filename"		Selects the interpretation file for user data if DISP:PROTocol:FORMAT FILE has been set.	2.10.8 <b>DISP</b> panel Proto File
<b>MMEM</b> ory: <b>LOAD:PAC</b>	"filename"		Selects the interpretation file for channel status data.	2.10.8 <b>DISP</b> panel Proto File
<b>DISP</b> lay: <b>PROT</b> ocol: <b>ERR</b> or: <b>GEN</b> era?r	Query only Response: UBB SQB NSYN PRMB SQLR RERR NONE		Query only Indicates errors occurred. "UBB" : unexpected preamble for beginning of block (too early) "SQB" : no preamble (blank) for beginning of block "NSYN" : no preamble for beginning of block "PRMB" : preamble invalid "SQLR" : error in the channel sequence (L/R) "RERR" : measured and set rate differ by more than 200 ppm "NONE" : no error	2.10.8 <b>GRAPH</b> panel <b>Display</b>

Command	Parameter	Basic unit	Meaning	Section
<b>DISPlay:PROTOCOL:ERROR:PARITY?</b>	Query only		Query only Displays the sum of all occurred parity errors. Zero reset by reselecting the analyzer or pressing the start key.	2.10.8 GRAPH panel Display
<b>DISPlay:PROTOCOL:ERROR:LCRC?</b>	Query only		Query only Internal counter of CRC errors (left)	2.10.8 GRAPH panel Display
<b>DISPlay:PROTOCOL:ERROR:RCRC?</b>	Query only		Query only Internal counter of CRC errors (right)	2.10.8 GRAPH panel Display
<b>DISPlay:PROTOCOL:CHSTATUS?</b>	Query only NO LTC YES		Query only Indicates changes in the channel status data. "NO" : No changes "LTC" : Changes in local-time-code only (bits 112 to 143) and CRC (bits 184 to 191). "YES" : Changes at another bit position.	2.10.8 GRAPH panel Display
<b>DISPlay:PROTOCOL:LR?</b>	Query only EQUAL DIFF		Query only Channel status data between left and right channel are ... "EQUAL" : same "DIFF" : different	2.10.8 GRAPH panel Display
<b>DISPlay:PROTOCOL:LVAL.bit?</b>	Query only Y0 N1		Query only Indicates the position of the validity bit in the left channel.	2.10.8 GRAPH panel Display
<b>DISPlay:PROTOCOL:RVAL.bit?</b>	Query only Y0 N1		Query only Indicates the position of the validity bit in the right channel.	2.10.8 GRAPH panel Display

## 3.10.7 Commands for Printing/Plotting of Screen and Storing in Files

Command	Parameter	Basic unit	Meaning	Section
<b>HCOPY:DESTINATION</b>	<p><i>PRSPc</i> alias <b>PRINter</b>  <i>PLHPgl</i> alias  <b>PLOTter</b>  <i>PRPS</i>  <i>PRHPgl</i></p> <p><b>FIPCx</b>,  'filename.PCX'  alias  <b>PCXFile</b>, 'name.PCX'</p> <p><b>FIHPgl</b>, 'filename.GL'  alias  <b>HPGLfile</b>, 'name.GL'</p> <p><b>FIPS</b>, 'filename.PS'  <b>FIEPs</b>, 'filename.EPS'</p> <p>For reasons of compatibility with existing programs the replays are as follows:  PRIN  PLOT  PRHP  PRPS  PCXF  HPGL  FIPS  FIEP</p>		<p>Screen copy  → to printer in the specified printer format (<b>PRSPC</b> = <b>SPeCial</b> printer format)  → to plotter in HPGL format  → to printer in PostScript format  → to printer in HPGL format taking into account the content of the prolog file C:\UPL\REF\GL_PRO.LOG and the epilog file C:\UPL\REF\GL_EPI.LOG.  → to file in PCX format  → to file in HPGL format  → to file in PostScript format  → to file in Encapsulated PostScript format</p>	<p><b>2.14</b>  <b>OPTIONS</b> panel  Destin  (destination/format)  → PRINTR/SPC  → PLOTTR/HPGL  → PRINTR/HPGL  → PRINTR/PS  → FILE/PCX  → FILE/HPGL  → FILE/PS  → FILE/EPS</p>



Command	Parameter	Basic unit	Meaning	Section
<b>HCOPY:DEVICE:COLOR</b>	<b>ON</b> <b>OFF</b>		→ PCX information stored in colors in the file specified by HCOP:DEST PCXFile, 'filename'. → PCX information stored in black/white in the file specified by HCOP:DEST PCXFile, 'filename'.	<b>2.14</b> <b>OPTIONS panel</b> COLOR → ON → OFF
<b>HCOPY:ITEM</b>	<b>ALL</b> <b>GRATicule</b> <b>TRACe</b>		Effective only with HCOPY:DESTination PLOTter HPGLfile → The complete screen is output, ie all labels and cursors as well as traces/bargraphs with scales. In the case of graphics windows the result display and a panel are output in addition. → Stores the traces/bargraphs with scales and scale labels but not the cursors and other labelling. → Only the trace(s) displayed is (are) transferred.	<b>2.14</b> <b>OPTIONS panel</b> Copy → SCREEN → CURVE/GRID → CURVE
<b>HCOPY:ITEM:LABel:STATe</b>	<b>ON</b> <b>OFF</b>		→ Hardcopy with comment → Hardcopy without comment	<b>2.14</b> <b>Key H COPY</b> or Ctrl F8
<b>HCOPY:DEVIce:PRINter</b>	<n>		Effective only with HCOPY:DESTination PRINter Selects a printer driver. The number <n> to be specified for the desired printer driver can be obtained from the printer-driver box "List of installable Printers" opened under "Printname" in the OPTIONS panel.	<b>2.14</b> <b>OPTIONS panel</b> Printname

Command	Parameter	Basic unit	Meaning	Section
<b>HCOPY:ITEM:FRAME</b>	<b>WHITE</b> <b>FDEFined</b>		Effective only with HCOpy:DESTination PRSPc FIPCx PRPS FIPS FIEPs  Selection of background color of GRAPH panel frame and result panel for hardcopies on a printer or storage in a .PCX file. WHITE should be selected when the characters cannot be clearly distinguished on the grey background. → White → Color defined via file For HCOpy:DEST PRSPc FIPCx: Color No. 2 (backgrnd frames) defined in files \UPD\REF\PRN_BW.PLT (BW printer) and \UPD\REF\PRN_CL.PLT (color printer) is used.  For HCOpy:DEST PRPS FIPS FIEPs: The color information for the frames of the GRAPH panel is taken from the PostScript configuration file \UPD\REF\FPS.CFG, key word "Background Color" "Frame:" and "Plane:" and available as RGB information for color PostScript pictures and as shades of grey for black/white PostScript pictures. Examples in file PS.CFG show the RGB combination for different background colors.	<b>2.14</b> <b>OPTIONS panel</b> Frame → WHITE → FILE DEF
<b>HCOPY:PLPort</b>	<b>COM2</b> <b>LPT1</b> <b>IEC</b>		Effective only with HCOpy:DESTination PLOTter → Hardcopy via serial interface 2. → Hardcopy via parallel printer interface. → Hardcopy via IEC/IEEE-bus interface.	<b>2.14</b> <b>OPTIONS panel</b> Plot on → COM 2 → LPT 1 → IEC BUS
<b>HCOPY:PLADdress</b>	<n>		Sets the IEC/IEEE-bus address of the plotter when HCOpy:DESTination PLOTter and HCOpy:PLPort IEC has been selected.	<b>2.14</b> <b>OPTIONS panel</b> → IEC Adr
<b>HCOPY:PAGE:LMARgin</b>	<n> 0 to 80		Margin of hardcopy (number of spaces)	<b>2.14</b> <b>OPTIONS panel</b> LEFT MRGN

Command	Parameter	Basic unit	Meaning	Section
<b>HCOPY:DEVICE:RESolution</b>	<b>HIGH</b> <b>MEDIUM</b> <b>LOW</b>		Sets the printer resolution. Whether a resolution can be set and which one depends on the printer used. → High resolution (eg 300 dpi) → Medium resolution (eg 150 dpi) → Low resolution (eg 75 dpi)	<b>2.14</b> <b>OPTIONS panel</b> Pm Resol → HIGH → MEDIUM → LOW
<b>HCOPY:PAGE:SCALE:X</b>	<n> 0.1 to 10		Scaling of X axis of hardcopy	<b>2.14</b> <b>OPTIONS panel</b> X-SCALING
<b>HCOPY:PAGE:SCALE:Y</b>	<n> 0.1 to 10		Scaling of Y axis of screen hardcopy	<b>2.14</b> <b>OPTIONS panel</b> Y-SCALING
<b>HCOPY:PAGE:ORIENTATION</b>	<b>LANDscape</b> <b>PORTrait</b>		→ Hardcopy in upright format → Hardcopy in landscape format	<b>2.14</b> <b>OPTIONS panel</b> ORIENTATION → LANDSCAPE → PORTRAIT
<b>HCOPY:PAGE:WIDTH?</b>	Query only		Indicates the hardcopy width in cm. The width of a hardcopy depends on the following settings: - HCOpy:DEvice:PRINter (selected printer) - HCOpy:PAGE:SCALE:X (X scaling) - HCOpy:DEvice:RESolution (resolution)	<b>2.14</b> <b>OPTIONS panel</b> Pm Width,
<b>HCOPY:PAGE:LENGTH?</b>	Query only		Indicates the hardcopy length in cm. The length of a hardcopy depends on the following settings: - HCOpy:DEvice:PRINter (selected printer) - HCOpy:PAGE:SCALE:Y (Y scaling) - HCOpy:DEvice:RESolution (resolution)	<b>2.14</b> <b>OPTIONS panel</b> Pm Height

Command	Parameter	Basic unit	Meaning	Section
<b>HCOPY:SIZE</b>	A4 LETTER		Form feed for a screen copy in PostScript format → UPL images are optimally positioned on format A4 (21 cm * 29.6 cm). → UPL images are optimally positioned on format LETTER (21.6 cm * 27.9 cm).	<b>2.14</b> <b>OPTIONS panel</b> Paper Size → A4 → LETTER
<b>HCOPY:PLOTS</b>	<n> 1 to 6		Number of UPL plots to be printed on a PostScript page.	<b>2.14</b> <b>OPTIONS panel</b> Plots/Page
<b>SYSTEM:PRINT</b>	TRACe1 TRACe2 EQUalize ERRors DWELL LIMLower LIMUpper LIST1 LIST2 TR1And2 OFF		Printout of numerals in ASCII code (including X axis).  → Printout of TRACe1. → Printout of TRACe2. → Printout of equalization values → Printout of values violating limits → Printout of timing values → Printout of lower limit values → Printout of upper limit values → X axis (eg sweep) → Z axis (eg sweep) → Printout of both traces → Switched off	<b>2.14.5</b> <b>OPTIONS panel</b> PRINT----- Type → TRACE A → TRACE B → EQUALIZATN → LIM REPORT → DWELL → LIM LOWER → LIM UPPER → X AXIS → Z AXIS → TRACE A+B → OFF

Command	Parameter	Basic unit	Meaning	Section
HCOPY[:IMMediate]	<p>Without parameter</p> <p><b>CNF</b> <b>CF</b> <b>NCNF</b> <b>NCF</b></p>		<p>Starts printout of the screen content</p> <p>Depending on command HCOP:DEST ... the current screen content is printed, plotted, or stored in a PCX or HPGL file or as a PostScript file. In the case of IEC/IEEE-bus and RS-232 control, only the result window and REMOTE are printed.</p> <p>A <b>remedy</b> is a HCOPY command with specified parameters which permits a hardcopy with preceding screen configuration to be printed.</p> <p><b>With setting</b> <b>HCOPY:DESTINATION PRINTER</b></p> <p>One of the four parameters CNF, CF, NCNF or NCF can be added to the HCOP command for printing the screen content with a comment:</p> <p><b>CNF:</b> Hardcopy with comment*, without form feed <b>CF:</b> Hardcopy with comment*, with form feed <b>NCNF:</b> Hardcopy without comment, without form feed <b>NCF:</b> Hardcopy without comment, with form feed</p> <p>Thus a specific screen configuration (3-panel, split-screen or full-screen display) can be output to the printer via IEC/IEEE bus, RS-232 or through UPL-B10 control.</p> <p>The desired screen configuration has to be selected before with command DISP:CONF ... (see end of section 3.10.6, Commands for Graphical Display of Results).</p> <p>The HCOP command with one of the 4 parameters switches the UPL from REMOTE to manual control, builds up the screen with the selected configuration, scans the screen content and starts the hardcopy.</p> <p>The next IEC/IEEE-bus command switches the UPL back to the REMOTE mode.</p> <p>Program example:</p> <pre> : IECOUT 20,"HCOPY:DESTINATION PRINTER" IECNREN:' Inhibits the LOCAL key ... IECREN:'... releases key blocking. IECOUT 20,"DISP:CONF GAT":' GEN, ANLR and FILTER panel IECOUT 20,"HCOP CF":' Triggers a hardcopy with comment , IECLLO:' Reactivates blocking of the LOCAL key. : </pre>	HCOPY command via IEC/IEEE bus, RS-232 or Universal Sequence Controller UPL-B10

Command	Parameter	Meaning	Section
<p>Cont'd  <b>HCOPY</b>[:IMMEDIATE]</p>	<p><b>CONFig</b></p>	<p>Cont'd:  <b>HCOPY:DESTINATION PRINTER</b>            If a screen copy without comment is output (HCOP:ITEM:LAB:STAT OFF), the desired screen configuration is first set with command DISP:CONF and then the HCOP command with parameter <b>CONF</b> is given.            Program example:            :  <b>IECOUT 20,"HCOPY:DESTINATION PRINTER"</b>  <b>IECNREN:</b>' Inhibits the LOCAL key ...  <b>IECREN:</b>'... releases key blocking.  <b>IECOUT 20,"DISP:CONF GAT":'</b> GEN, ANLR and FILTER panel  <b>IECOUT 20,"HCOP CONF":'</b> Trigg. a hcopy without comment  <b>IECLLO:</b>' Reactivates blocking of the LOCAL key.            :  <b>With setting</b>  <b>HCOPY:DESTINATION PCXFile,'filename':</b>            The desired screen configuration has to be selected first with command DISP:CONF ...            see end of section 3.10.6, Commands for Graphics Display of Results).            The HCOP command with parameter <b>CONF</b> switches the UPL from REMOTE to manual control, builds up the screen with the selected configuration, scans the screen content and starts a hardcopy into the file.            The next IEC/IEEE-bus command reset the UPL to the REMOTE mode.            Program example:            :  <b>IECOUT 20,"HCOPY:DESTINATION PCXFile,'filename'"</b>  <b>IECNREN:</b>' Inhibits the LOCAL key ...  <b>IECREN:</b>'... releases key blocking  <b>IECOUT 20,"DISP:CONF GAT":'</b> GEN, ANLR and FILTER panel  <b>IECOUT 20,"HCOP CONF":'</b> Triggers a hardcopy without comment  <b>IECLLO:</b>' Reactivates blocking of the LOCAL key.            :</p>	<p><b>HCOPY</b> command via IEC/IEEE bus, RS-232 or Universal Sequence Controller UPL-B10</p>

Command	Parameter	Meaning	Section
Cont'd HCOPY[:IMMediate]	TITLE SUPPLEMENT	<p><b>With settings</b>            HCOPY:DESTINATION PRPS            HCOPY:DESTINATION FIPS, 'filename.PS'            HCOPY:DESTINATION FIEPs, 'filename.EPS'</p> <p>A comment* can be added to the PostScript plot as a <b>TITLE</b> or caption (<b>SUPPLEMENT</b>).</p> <p>Thus a specific screen configuration (3-panel, split-screen or full-screen display) can be output to the PostScript printer or a PostScript file via IEC/IEEE bus, RS-232 or through UPL-B10 control.</p> <p>A selection can be made with command HCOPY:ITEM ALL GRAT TRAC whether the whole screen content (ALL), only traces and scales (GRAT) or only traces (TRAC) are output as PostScript plot or stored in a PostScript file. When a hardcopy of traces is to be made (HCOP:ITEM GRAT TRAC) make sure that the screen configuration selected with DISP:CONF P S A P G F P D P O P allows traces to be plotted. The HCOP command with one of the three parameters switches the UPL from the REMOTE to the manual control mode, builds up the selected configuration, scans the screen content and starts the hardcopy. The next IEC/IEEE-bus command resets the UPL to REMOTE.</p> <p>Program example:</p> <pre>           :           IECCOUT 20,"HCOPY:DESTINATION FIPS, 'filename.PS'"           IECCNREN:' Inhibits the LOCAL key ...           IECCREN:' ... disables key blocking.           IECCOUT 20,"DISP:CONF GAT":' GEN, ANLR and FILTER panel           IECCOUT 20,"HCOP TITL":' Triggers a hardcopy with a           comment as a title           IECCLO:' Reactivates blocking of the LOCAL key.           :</pre>	HCOPY command via IEC/IEEE bus, RS-232 or Universal Sequence Controller UPL-B10

Command	Parameter	Meaning	Section
<p>Cont'd  <b>HCOPY</b>[:IMMEDIATE]</p>	<p><b>CONFig</b></p>	<p>Cont'd:  <b>With settings</b>  <b>HCOPY:DESTINATION PRPS</b>  <b>HCOPY:DESTINATION FIPS, 'filename.PS'</b>  <b>HCOPY:DESTINATION FIEPs, 'filename.EPS'</b></p> <p>If a screen copy without comment (HCOP:ITEM:LAB:STAT OFF) is output, the desired screen configuration is first set with command DISP:CONF and then the HCOP command with parameter CONF is triggered.</p> <p>Program example:</p> <pre> : IECOUT 20, " HCOpy:DESTINATION FIPS, 'filename.PS' " IECNREN:' Inhibits the LOCAL key ... IECREN:... disables key blocking. IECOUT 20,"DISP:CONF GAT":' GEN, ANLR and FILTER panel IECOUT 20,"HCOP CONF":' Trigg. a hcopy without comment IECLLO:' Reactivates blocking of the LOCAL key. : </pre>	<p><b>HCOPY</b> command via IEC/IEEE bus, RS-232 or Universal Sequence Controller UPL-B10</p>



Command	Parameter	Meaning	Section
Conf'd HCOPY[:IMMEDIATE]	CONFg	<p><b>With settings</b>  <b>HCOPY:DESTINATION PLOTter</b> and  <b>HCOPY:DESTINATION PRHPg</b>  <b>HCOPY:DESTINATION HPGLfile, filename':</b>            The default parameter <b>CONF</b> triggers a hardcopy to a plotter, a HPGL-compatible printer or a HPGL file with preceding screen configuration. A comment cannot be output.            In addition to the screen configuration selected with <b>DISP:CONF ...</b> a selection can be made with command <b>HCOPY:ITEM ALL GRAT TRAC</b> whether the total screen content (<b>ALL</b>), only traces with scales (<b>GRAT</b>) or only traces (<b>TRAC</b>) are plotted or transferred to the HPGL file. When traces are to be plotted (<b>HCOPY:ITEM GRAT TRAC</b>) make sure that a screen configuration allowing traces to be plotted has been selected with <b>DISP:CONF P SP AP GP FP DP OP</b>.</p> <p>The <b>HCOP</b> command with one of the three parameters switches the UPL from <b>REMOTE</b> control to manual control, builds up the screen with the selected configuration, scans the screen content and starts the hardcopy.            The next <b>IEC/IEEE-bus</b> command resets the UPL to <b>REMOTE</b> control.</p> <p>Program example:            ;  <b>IECOUT 20, "HCOPY:DESTINATION PLOTter"</b>  <b>IECNREN:</b>' Inhibits the LOCAL key ...  <b>IECREN:</b>' ... releases key blocking.  <b>IECOUT 20, "DISP:CONF GAT":' GEN, ANLR and FILTER panel</b>  <b>IECOUT 20, "HCOP CONF":' Triggers a hardcopy</b>  <b>IECLLO:</b>' Reactivates blocking of the LOCAL key.            ;</p> <p><b>Note:</b>  <i>No further HCOP command may be given while a hardcopy is being executed (printed), since a command would abort the printout.</i></p>	<b>HCOPY</b> command via IEC/IEEE bus, RS-232 or Universal Sequence Controller UPL-B10
<b>HCOPY:WAIT</b>		Starts the printout (see above) The next Basic command is not carried out before printing (with optimum speed) in the background is completed.	<b>No manual control</b>
<b>HCOPY:ABORT</b>		Aborts the hardcopy.	<b>2.14</b> <b>Key H COPY</b> or <b>CTRL F8</b>

### 3.10.8 Setting and Display of Auxiliary Parameters

#### 3.10.8.1 IEC/IEEE-Bus Address

Command	Parameter	Basic unit	Meaning	Section
<b>SYSTEM:COMMunicate:GPIB:ADDRESS</b>	<n> 0 to 31		IEC/IEEE bus address of UPL	2.15.1 <b>OPTIONS panel</b> UPL IECadr

#### 3.10.8.2 Switching the Beeper On/Off

Command	Parameter	Basic unit	Meaning	Section
<b>SYSTEM:BEEPer:STATE</b>	ON OFF		→ Beeper on → Beeper off	2.15.2 <b>OPTIONS panel</b> Beeper → ON → OFF

## 3.10.8.3 MACRO Operating

Command	Parameter	Basic unit	Meaning	Section
<b>SYSTEM:PROGRAM:EXECUTE</b>	'filename'		By means of this command any BASIC program with the name <filename> (preferred file extension: *BAS) can be loaded and started. After the program has been quit, a 1 → 0 transition is generated in the RUN bit (#14) of the operation register. This is communicated to the controller via SRQ or serial poll so that it can fetch the measurement results. Data exchange between the external control program and the BASIC program can be performed via the measurement-result displays, the measurement-result buffers or the block data input/output by adding on the command SYST:PROG <n>{,<n>}. For a detailed example see 3.15.18 Call BASIC-Macro.  Only in IEC/IEEE-bus or RS232-remote-control mode can a BASIC macro be started with this command. A program supplied by the Universal Autorun Control UPD-K1 <b>cannot</b> start a BASIC macro.	2.15.9 Selecting the Sampling Mode  2.16 <b>OPTIONS-Panel</b> Exec Macro <filename>
<b>SYSTEM:PROGRAM[:DATA]</b>	<n>{,<n>}		Up to 1024 various floating-point values can be transferred to the external control program from a BASIC macro. To do this, the values are written to the block buffer by the BASIC macro and then read by the external control program. For a detailed example see 3.15.18 Call BASIC-Macro	<b>No manual control</b>
<b>SYSTEM:PROGRAM:POINTS?</b>	<n> 0 to 1024 Query only		Number of the available block-data values written to the block buffer by the BASIC macro.	<b>No manual control</b>

## 3.10.8.4 Transfer of Settings

Command	Parameter	Basic unit	Meaning	Section
<b>SYSTEM:PARAMeter:LINK</b>	<n> *) 0 to 2047		Permits transfer of settings in the generator or analyzer to another signal or measurement function or to another instrument.	<b>2.15.7 OPTIONS</b> panel Param. Link

\*)

## Calculation of &lt;n&gt;:

Data bit	Weight	Function
d0 (LSB)	1	Changing generator function keeps FUNCTION parameters
d1	2	Changing generator instrument keeps Output Config
d2	4	Changing generator instrument keeps FUNCTION + Parameters
d3	8	Changing analyzer function keeps FUNCTION parameters
d4	16	Changing analyzer instrument keeps Input Configuration
d5	32	Changing analyzer instrument keeps START COND
d6	64	Changing analyzer instrument keeps INPUT DISP
d7	128	Changing analyzer instrument keeps FREQ/PHASE
d8	256	not used
d9	512	Changing analyzer instrument keeps FUNCTION + Parameters
d10 (MSB)	1024	Changing generator function (tracking Gen → AnI) the appropriate measurement function for the analyzer is set. (MDIST, DFD, POL, FM → W&F)

Example: Function of d0, d3, d9 and d10 required

Databit:	d10	d9	d8	d7	d6	d5	d4	d3	d2	d1	d0
Data word:	1	1	0	0	0	0	0	1	0	0	1
Weighting:	1024	512	256	128	64	32	16	8	4	2	1

n = Sum of the weighting of the set bits  
 $n = 1 + 8 + 512 + 1024$   
**n =1545**

3.10.8.5 Selecting the Sampling Mode

<p>CONFigure:DAI</p>	<p><b>BRM</b></p> <p><b>HRM</b></p>	<p>When hardware option UPL-B29 (Digital Audio 96 kHz) is installed, UPL can be operated in two different sampling modes:</p> <p>→ Base Rate Mode</p> <p>Option UPL-B29 (Digital Audio 96 kHz) generally functions like option UPL-B2 (Digital Audio I/O). Clock frequencies up to 55 kHz can be generated and analyzed. Maximum performance of UPL performance without reduction of functions.</p> <p>→ High Rate Mode</p> <p>Option UPL-B29 (Digital Audio 96 kHz) permits generation and analysis in the High Rate Mode with clock frequencies up to 106 kHz. Some measurement functions in 2-channel operation are performed at lower speed. Analyzer functions are slightly reduced:</p> <ul style="list-style-type: none"> <li>• no RUB&amp;BUZZ measurement</li> <li>• THIRD OCT measurement only analog</li> <li>• THIRD OCT, WAVEFORM, PEAK and QPEAK measurements only without filter</li> <li>• digital phase measurement not possible with all measurement functions</li> </ul> <p><i>Note: In the HRM even the performance and functions of analog measurements are reduced. This mode should therefore only be selected when the higher sampling rate is really required in the generator or analyzer.</i></p>	<p><b>2.15.9</b>  <b>OPTIONS panel</b>                  Sampl Mode                  → BASE RATE                  → HIGH RATE</p>
----------------------	-------------------------------------	--	--

### 3.10.8.6 Parameters of COM2 Interface

The parameters to be set in this section apply to a screen printout on a plotter with COM2 interface selected.  
(HCOP:DEST PLOT mit HCOP:PLP COM2).

Command	Parameter	Basic unit	Meaning	Section
<b>SYSTEM:COMMunicate:SERial2:FEED:BAUD</b>	<n> n = 2400 3600 4800 7200 9600 19200 38400 56000		Transmission speed in baud (bits/s) (default setting: 9600)	<b>2.15.1 OPTIONS panel</b> Baud Rate → 2400 Baud → 3600 Baud → 4800 Baud → 9600 Baud → 19200 Baud → 38400 Baud → 56000 Baud
<b>SYSTEM:COMMunicate:SERial2:FEED:PARity[:TYPE]</b>	NONE EVEN ODD		Parity check → Parity check off → Check for even parity (default setting) → Check for odd parity	<b>2.15.1 OPTIONS panel</b> Parity → NONE → EVEN → ODD
<b>SYSTEM:COMMunicate:SERial2:FEED:BITS</b>	<n> n = 7   8		Number of data bits (default setting: 7)	<b>2.15.1 OPTIONS panel</b> Data Bits → 7 → 8
<b>SYSTEM:COMMunicate:GTL</b>			Return to manual operation. This command is only required in case of remote control via RS-232 but can also be used for IEC/IEEE-bus operation and Universal Sequence Controller UPL-B10.	<b>LOCAL keystroke</b>

Command	Parameter	Basic unit	Meaning	Section
<b>SYSTEM:COMMunicate:SERial2:FEED:SBITs</b>	<n> n = 1   2		Number of stop bits (default setting: 1)	2.15.1 <b>OPTIONS</b> panel Stop Bits → 1 → 2
<b>SYSTEM:COMMunicate:SERial2:CONTrol</b>	RTS XON		Type of synchronization → Hardware handshake via RTS and CTS line (default setting) → Software handshake	2.15.1 <b>OPTIONS</b> panel Handshake → RTS/CTS → XON/XOFF

### 3.10.8.7 Keyboard Settings

Command	Parameter	Basic unit	Meaning	Section
<b>SYSTEM:KEY:RRATE</b>	<nu> 0 to 50 Hz	Hz	Repetition rate of UPL and AT keyboard	2.15.3 <b>OPTIONS</b> panel Reptn Rate
<b>SYSTEM:KEY:RDELAY</b>	<nu> 0.25 to 1.0 s	s	Response delay of UPL and AT keyboard	2.15.3 <b>OPTIONS</b> panel Rep Delay

## 3.10.8.8 Display Settings

Command	Parameter	Basic unit	Meaning	Section
<b>DISP</b> lay:MODE	<b>INTern</b> <b>COLBoth</b> <b>BWBoth</b> <b>AUTO</b>		<ul style="list-style-type: none"> <li>→ Display on internal LCD</li> <li>→ Additional display on external color monitor</li> <li>→ Additional display on external monochrome monitor</li> <li>→ Additional display on external VGA monitor; the display mode (color or monochrome) is adapted to the built-in LCD. The display is thus optimized for the built-in LCD so that the contrast quality will not be affected.</li> </ul>	2.15.5 <b>OPTIONS panel</b> Extrn Disp → INTERN ONLY → BOTH COLOR → BOTH B/W → BOTH AUTO
<b>DISP</b> lay:ANNotation[:ALL]	<b>ON</b> <b>OFF</b>		<ul style="list-style-type: none"> <li>→ Display of measurement results and status</li> <li>→ Result and status display cleared (FFT, sweep and IEC/IEEE-bus operation speeded up).</li> </ul>	2.15.5 <b>OPTIONS panel</b> Meas Disp → ON → OFF Ext. Keyboard: CTRL D
<b>DISP</b> lay:ACTualize	<b>ON</b> <b>OFF</b>		<p>This command may be called from Universal Autorun Control UPD-K1 or via the IEC/IEEE bus or by means of RS232 remote control.</p> <ul style="list-style-type: none"> <li>→ Updates the graphics panel and repeats the update every time commands are output which change the graphics display in the UPL, eg DISPLAY:WINDOW]:TRACe[:X[:SCALE]:AUTO ON.</li> <li>→ The graphics panel is not updated not even after commands changing the graphics display in the UPL.</li> </ul> <p><b>Note:</b> To enhance speed, it is best to <b>turn off the graphic when the remote-control mode is selected</b>. Graphics should only be activated when traces are to be displayed.</p>	<b>No manual control</b>

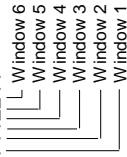

Command	Parameter	Basic unit	Meaning	Section															
<b>SYSTEM:DISPLAY:READING:RATE</b>	<p>MAXSpeed FSTSspeed MEDSspeed SLWSspeed</p>		<p>Presetting for manual control. Determines the rate for the output of measured values in the result windows. The setting is only effective in the continuous measurement mode. In the case of sweeps and triggered measurements as well as with all measurements via IEC/IEEE bus, results are always output at maximum speed. → Max. output speed → 6 results/second → 3 results/second → 1 result/second</p>	<p>2.15.5 <b>OPTIONS panel</b> Read Rate → MAX SPEED → 6/s → 3/s → 1/s</p>															
<b>SYSTEM:DISPLAY:READING:RESolution</b>	<n>		<p>Presetting for manual control. Sets the number of decimal digits for the display of measured values in the result windows. With measurements via IEC/IEEE bus results are always displayed with maximum resolution. Decimal digits for the 6 result windows are specified by 6 numbers between 0 and 6 (higher numbers are interpreted as 6). 0: Automatic display of decimal digits 1 to 6: 1 to 6 decimal digits  Each number is assigned to a result window:</p> <table border="1" data-bbox="893 649 1045 1086"> <tr> <td>Function</td> <td>Input peak</td> <td>Frequency</td> </tr> <tr> <td>CH1</td> <td>Window 1</td> <td>Window 3</td> </tr> <tr> <td>CH2</td> <td>Window 2</td> <td>Window 4</td> </tr> <tr> <td></td> <td></td> <td>Window 5</td> </tr> <tr> <td></td> <td></td> <td>Window 6</td> </tr> </table> <p>SYSTEM:DISPlay:READIng:RESolution 112244</p>  <p>Leading zeros may be omitted so that for &lt;n&gt; = 34, for example, the result in window 6 is displayed with 4 decimal digits, the result in window 5 with 3 and the results in windows 1 to 4 without any decimal digits at all.</p>	Function	Input peak	Frequency	CH1	Window 1	Window 3	CH2	Window 2	Window 4			Window 5			Window 6	<p>2.15.5 <b>OPTIONS panel</b> Read Resol</p>
Function	Input peak	Frequency																	
CH1	Window 1	Window 3																	
CH2	Window 2	Window 4																	
		Window 5																	
		Window 6																	

Command	Parameter	Basic unit	Meaning	Section
<b>SYSTEM:DISPlay:TRACe[]:LOAD</b>	<b>MANual</b>		→ For each scan of a trace group (to be selected with the subsequent command SYST:DISP:TRAC[1 2]:SEL <n>) a color and the line pattern can be selected for the display.	<b>2.15.5.4 OPTIONS panel</b> Scan conf → MANUAL → DEFAULT → AUTO COLOR → AUTO LINE
	<b>DEFault</b>		→ Automatic assignment of color and line pattern to max. 17 scans for Trace A and Trace B. All scans of Trace A are green uninterrupted with thin lines, those of Trace B yellow dotted with thin lines.	
	<b>ACOLor</b>		→ Automatic assignment of color to 17 scans for Trace A and Trace B. ALL scans of Trace A in uninterrupted thin lines, all scans of Trace B in dotted thin lines.	
	<b>ALINE</b>		→ Automatic assignment of line pattern to 17 scans of Trace A and Trace B. All scans of Trace A in green, all scans of Trace B in yellow.	
<b>SYSTEM:DISPlay:TRACe[1 2]:SElect</b>	<n> 1 to 17		Scan number of trace group to which a color or line pattern is to be assigned with the two subsequent commands SYST:DISP:TRAC[1 2]:COL and SYST:DISP:TRAC[1 2]:LINE for screen display.	<b>2.15.5.4 OPTIONS panel</b> Scannr. (A) Scannr. (B)
<b>SYSTEM:DISPlay:TRACe[1 2]:COLor</b>	<b>GREEN</b> <b>YELLOW</b> <b>BLUE</b> <b>CYAN</b> <b>MAGenta</b> <b>WHITE</b>  <b>BLACK</b> <b>DGRay</b> <b>LGRay</b>		Assignment of color to the scan number specified with command SYST:DISP:TRAC[1 2]:SEL <n> when color display is selected.  Shades of grey with monochrome display selected.  Newly assigned colors are only visible on the screen after the LOCAL mode has been restored.	<b>2.15.5.4 OPTIONS panel</b> Color (A) / (B) → GREEN → YELLOW → BLUE → CYAN → MAGENTA → WHITE  → BLACK → DARK GRAY → LIGHT GRAY

Command	Parameter	Basic unit	Meaning	Section
<b>SYSTEM:DISP</b> lay:TRACe[1 2]:LINE	SSOLid SD SP SPD DSOLid DD DP DPD		Line patterns for the scan number specified with command SYST:DISP:TRAC[1 2]:SEL <n>. → thin continuous line → dashed line → dotted line → dash-dot line → three-times-wide continuous line → dashed line → dotted line → dash-dot line  The newly assigned line pattern is only visible on the screen after the LOCAL mode has been restored.	2.15.5.4 OPTIONS panel Line (A) / (B) → ————— → - - - - - → . . . . . → . - . - . - →     → ==== → ::::: → : :: : : : → : : : : : : :

## 3.10.8.9 Version Display

Command	Parameter	Basic unit	Meaning	Section
<b>SYSTEM:SOFTWARE:VERSION?</b>	<b>SOFTWARE SETUP</b> Query only Query: SYST:SOFT:VERS? SOFT SYST:SOFT:VERS? SETU The response is the number of a version (eg 3.05).		→ Version number of UPL software → Version number of setup	2.15.7 <b>OPTIONS panel</b> VERSIONS ----- Software Setup
<b>SYSTEM:AHARDWARE:VERSION?</b>	<b>ABOARD ACODE</b> Query only Query: SYST:AHAR:VERS? ABO SYST:AHAR:VERS? ACOD The response is either the number of a version (eg 0.01) or -NA- (Not Available) if the board is not installed.		→ Version number of analog board → Version number of generator source impedance with the BAL output selected: Query reply 0.00: generator source impedance 200 Ω (standard value) 0.01: generator source impedance 150 Ω with the standard generator source impedance changed from 200 Ω to 150 Ω using the Modification Analog Generator UPL-U3 (Order No. 1078.4900.02)	2.15.7 <b>OPTIONS panel</b> VERSIONS ----- Anlg Board code

Command	Parameter	Basic unit	Meaning	Section
<b>SYSTEM:DHAR</b> ware: <i>VERSION?</i>	<b>CPUboard</b> <b>DBOard</b>  Query only  Query: SYST:DHAR:VERS? CPU SYST:DHAR:VERS? DBO The response is the number of a version (eg 0.05).		→ CPU board 3.86   4.86 (386-CPU, 486-CPU) → Version number of digital board	2.15.7 <b>OPTIONS panel</b> VERSIONS ----- <b>CPU board</b> Digl. Board
<b>SYSTEM:OPT</b> ions: <i>VERSION?</i>	<b>LDG</b> <b>REMO</b> te <b>DAUD</b> io  <b>Answer:</b> 1.15 to 1.27 UPL16 (U8) 1.46 to 1.51 UPL-B2 2.16 to 2.23: UPL-B29  <b>SPE</b> aker <b>DAPR</b> otocol <b>DAJ</b> itter <b>SQCO</b> ntrol  The response is either the number of an option (eg 0.01), INST or - NA- (Not Available) if the board or option are not installed.		Version display of options → Low Distortion Generator → Remote Control B4) → Digital Audio I/O Digital Audio 96 kHz Acoustic measurements on GSM mobile stations (UPL16)  → Audio Monitor → Digital Audio Protocol → Jitter and Interface Test → Universal Sequence Controller → Line measurement to ITU-T33 → Extended analyzer functions → <b>Mobile Phone Test Set</b>	2.15.7 2.6.6 <b>OPTIONS panel</b> OPTIONS ----- B1 Low Dist B4 Rem Ctrl B2 DigAudio B5 Speaker B21 DA Prot B22 DA Jitt B10 Seq Ctrl ITU-T O33 B6 Coher B8 PhoneTst

## 3.10.8.10 Calibration

Command	Parameter	Basic unit	Meaning	Section
<b>CALibrate:LDG:AUTO</b>	<b>OFF</b> <b>ONCE</b>		<ul style="list-style-type: none"> <li>→ No calibration of low-distortion generator</li> <li>→ Triggers an automatic calibration of the low-distortion generator. This should be after one hour of operation at the earliest.</li> </ul>	2.15.6 <b>OPTIONS panel</b> CALIBR. GEN LDG Auto → OFF → ONCE
<b>CALibrate:ZERO:AUTO</b>	<b>OFF</b> <b>ON</b> <b>ONCE</b>		<ul style="list-style-type: none"> <li>→ No offset calibration</li> <li>→ Offset calibration cyclic and after a change of analyzer/instrument.</li> <li>→ Manual triggering of offset calibration; then reset to ON</li> </ul>	2.15.6 <b>OPTIONS panel</b> CALIBR. ANL Zero Auto → OFF → ON → ONCE
<b>CALibrate:JITTer:AUTO</b>	<b>OFF</b> <b>ONCE</b>		<ul style="list-style-type: none"> <li>→ No calibration of digital Phase to Ref measurement.</li> <li>→ Manual triggering of automatic calibration of digital Phase to Ref measurement; then reset to OFF.</li> </ul>	2.15.6 <b>OPTIONS panel</b> CALIBR. DIG PhaseToRef → OFF → ONCE
<b>CALibrate</b>	<b>OFF</b> <b>AUTO</b> <b>DCC</b> <b>LDG</b>		<ul style="list-style-type: none"> <li>→ No offset calibration.</li> <li>Equivalent to CALibrate:ZERO:AUTO OFF.</li> <li>→ Offset calibration cyclic and after a change of analyzer/instrument.</li> <li>Equivalent to CALibrate:ZERO:AUTO ON.</li> <li>→ Manual triggering of offset calibration; then reset to AUTO.</li> <li>Equivalent to CALibrate:ZERO:AUTO ONCE.</li> <li>→ Automatic calibration of low-distortion generator. This should be after one hour of operation at the earliest.</li> <li>Equivalent to CALibrate LDG:AUTO ONCE.</li> </ul>	2.15.6

## 3.10.8.11 Loading Speed for Setups and Analyzer Measurement Functions

Command	Parameter	Basic unit	Meaning	Section
<b>SYSTEM:LSpeed</b>	<b>FAST</b>		<p>Speed for loading setups and analyzer measurement functions  → Loading setups and analyzer functions can be speeded up while <b>FAST</b> is active.  (considerably faster than SLOW), given the following minor restrictions:</p> <ul style="list-style-type: none"> <li>• During loading of setups and changing analyzer functions the graphics system is not initialized, IEC/IEEE-bus commands for the graphics systems have no effect and are rejected with an error message. K1 commands UPLGTLU und UPLGTLG cannot be used for graphic display (see section 3.16.4.3, Basic Extensions).</li> <li>• When analyzer measurement functions are changed, the currently set function is not stored, ie after switching back to the previously set function, the parameters of the slower mode (SYST:LSP SLOW) will be set.</li> <li>• When an *RST is performed, the output of measurement results is suppressed so as if the command DISP:ANN OFF were output. When the IEC/IEEE-bus is quit, (LOCAL key or IEC/IEEE-bus command GTL) the slower load mode is set without the above-mentioned restrictions.</li> </ul>	<b>No manual operation</b>
	<b>SLOW</b>		<p>→ without restrictions, therefore slower than FAST (default setting).</p>	

## 3.10.9 Commands for Data Output

Command	Parameter	Basic unit	Meaning	Section
<b>SENSe[1]:DATA1 2?</b>	Query only	Depending on FUNC	Returns the measured value of the 1st analyzer for RMS, RMSS, PEAK, QPE, DC, THD, THDN, MDIST, DFD and WAF functions. DATA1 selects input channel 1 DATA2 selects input channel 2.	3.15.8 No manual control Result display
<b>SENSe2:DATA1 2?</b>	Query only	V/FS	Returns the measured value of the 2nd analyzer (peak voltage meter). DATA1 selects input channel 1 DATA2 selects input channel 2.	3.15.8 No manual control Result display
<b>SENSe3:DATA1 2?</b>	Query only	Hz	Returns the measured value of 3rd analyzer (frequency counter). DATA1 selects input channel 1 DATA2 selects input channel 2.	3.15.8 No manual control Result display
<b>SENSe4:DATA?</b>	Query only	DEG	Returns the measured value of the 4th analyzer (phase meter).	3.15.8 No manual control Result display

Write access to the measurement-result buffers is also possible with Universal Autorun Control (UPD-K1) or remote control (IEC/IEEE bus interface). This is of particular interest for operation with BASIC macros:

- The measurement results calculated by a BASIC macro can be displayed in the usual measurement-result window.
- Any floating-point parameters and measurement results may be exchanged between the BASIC macro and the controller via the measurement-result buffers. For a detailed example see 3.15.18 Call BASIC-Macro.



## 3.10.10 Commands for Input/Output of Block Data

Command	Parameter	Basic unit	Meaning	Section
<b>FORMat</b> [:DATA]	ASCII REAL		→ Determines the numeric format for block data only. Output of numbers with sign, point and possibly exponent (default). → Determines the numeric format for block data only. Output in binary form. This setting is not stored in the setup and set to ASCII each time the UPL is switched on.	No manual control
<b>SENSe</b> [1]: <b>LIST:FREQUENCY</b> <b>SOURCE:LIST:FREQUENCY</b>	<n>{,<n>} <n>{,<n>}	Hz	These two commands are identical and specify the block data for a frequency sweep or frequencies for a sequence of measurements. When limit or equalization curves are specified, the frequencies are to be sorted in ascending or descending order.	2.9.1.3 No manual control
<b>SENSe</b> [1]: <b>LIST:FREQUENCY:POINTS?</b> <b>SOURCE:LIST:FREQUENCY:POINTS?</b>	<n> 0 to 1023 Query only		The two commands are identical and return the number of currently available block data for the frequency axis.	2.9.1.3 No manual control
<b>SOURCE:LIST:VOLTage</b>	<n>{,<n>}	V	Specifies the block data for a voltage sweep or the output voltage for a sequence of measurements.	2.9.1.3 No manual control
<b>SOURCE:LIST:VOLTage:POINTS?</b>	<n> 0 to 1023 Query only		Returns the number of currently available block data for the voltage axis.	2.9.1.3 No manual control
<b>SOURCE:LIST:ONTime</b>	<n>{,<n>}	S	Specifies the block data for a sweep of the on-time and off-time ratio of the burst signal or of a sequence of measurements.	2.9.1.3 No manual control
<b>SOURCE:LIST:ONTime:POINTS?</b>	<n> 0 to 1023 Query only		Returns the number of currently available block data for the on-time axis.	2.9.1.3 No manual control
<b>SOURCE:LIST:INTERval</b>	<n>{,<n>}		Specifies the block data for a sweep of the on-time to off-time ratio of the burst signal or a sequence of measurements.	2.9.1.3 No manual control

Command	Parameter	Basic unit	Meaning	Section
<b>SOURCE:LIST:INTERVAL:POINTS?</b>	<n> 0 to 1023 Query only		Returns the number of currently available block data for the interval axis.	2.9.1.3 No manual control
<b>SOURCE:LIST:DWELI</b>	<n>{,<n>}	s	Specifies the block data for the dwell time of a sweep or a measurement sequence.	2.9.1.3 No manual control
<b>SOURCE:LIST:DWELI:POINTS?</b>	<n> 0 to 1023 Query only		Returns the number of currently available block data for the dwell time.	2.9.1.3 No manual control
<b>SOURCE:LIST:DWELI:CONTROL[:DATA]</b>	<n>{,<n>}		X axis for the dwell time.	2.9.1.3 No manual control
<b>SOURCE:LIST:DWELI:CONTROL:POINTS?</b>	<n> 0 to 1023 Query only		Returns the number of currently available block data for the dwell time.	2.9.1.3 No manual control
<b>SOURCE:VOLTage:EQUALize[:DATA]</b>	<n>{,<n>}		Specifies the block data for the voltage axis of the equalization curve.	2.9.1.3 No manual control
<b>SOURCE:VOLTage:EQUALize:POINTS?</b>	<n> 0 to 1023 Query only		Returns the number of currently available block data for the voltage equalization list.	2.9.1.3 No manual control
<b>SOURCE:EQUALize:CONTROL[:DATA]</b>	<n>{,<n>}		Specifies the block data for the frequency axis of the equalization curve.	2.9.1.3 No manual control
<b>SOURCE:EQUALize:CONTROL:POINTS?</b>	<n> 0 to 1023 Query only		Returns the number of currently available block data for the frequency axis of the equalization curve.	2.9.1.3 No manual control

Command	Parameter	Basic unit	Meaning	Section
<b>SENSE:VOLTage:EQUalize[:DATA]</b>	<n>{,<n>}		Block data for voltage axis of equalization curve for measurement functions THD+N and FFT.	2.9.1.3 No manual operation
<b>SENSE:VOLTage:EQUalize:POINts?</b>	<n> 0 to 1024 Query only		Returns the number of currently available block data values of the voltage equalization list for measurement functions THD+N and FFT.	2.9.1.3 No manual operation
<b>SENSE:EQUalize:CONTRol[:DATA]</b>	<n>{,<n>}		Block data for frequency axis of equalization curve for measurement functions THD+N and FFT.	2.9.1.3 No manual operation
<b>SENSE:EQUalize:CONTRol:POINts?</b>	<n> 0 to 1024 Query only		Returns the number of currently available block data values for the frequency axis of the equalization curve for measurement functions THD+N and FFT.	2.9.1.3 No manual operation
<b>CALCulate:LIMit:UPPer[:DATA]</b>	<n>{,<n>}	1)	Specifies the block data for the Y axis of the upper limit curve.	2.9.1.3 No manual control
<b>CALCulate:LIMit:UPPer:TRACe</b>	<n>{,<n>}		Returns the block data for the y axis of the <b>upper</b> limit trace interpolated along the x axis. The command <code>trac:points?</code> <code>list1</code> gives the number of x values, which were used for interpolation. It is the same as the number of interpolated y values for the <b>upper</b> limit trace.	2.9.1.3 Keine Handbedienung
<b>CALCulate:LIMit:UPPer:POINts?</b>	<n> 0 to 1023 Query only		Returns the number of currently available block data for the Y axis of the upper limit curve.	2.9.1.3 No manual control
<b>CALCulate:LIMit:UPPer:CONTRol[:DATA]</b>	<n>{,<n>}		Specifies the block data for the X axis of the limit curves	2.9.1.3 No manual control
<b>CALCulate:LIMit:UPPer:CONTRol:POINts?</b>	<n> 0 to 1023 Query only		Returns the number of currently available block data for the X axis of the limit curves.	2.9.1.3 No manual control

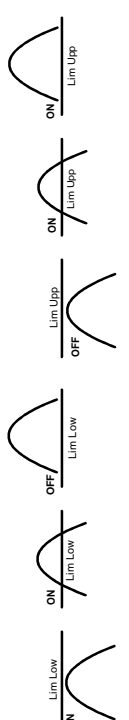
Command	Parameter	Basic unit	Meaning	Section
<b>CALCulate:LIMIT:LOWER:DATA</b>	<n>{,<n>} 1)		Specifies the block data for the Y axis of the lower limit curve.	2.9.1.3 No manual control
<b>CALCulate:LIMIT:LOWER:TRACE</b>	<n>{,<n>} 0 to 1023 Query only		Returns the block data for the y axis of the <b>lower</b> limit trace interpolated along the x axis. The command <code>trac:points? list1</code> gives the number of x values, which were used for interpolation. It is the same as the number of interpolated y values for the <b>lower</b> limit trace.	2.9.1.3 Keine Handbedienung
<b>CALCulate:LIMIT:LOWER:POINTS?</b>	<n> 0 to 1023 Query only		Returns the number of currently available block data for the Y axis of the lower limit curve.	2.9.1.3 No manual control
<b>CALCulate:LIMIT:LOWER:CONTROL[:DATA]</b>	<n>{,<n>} 0 to 1023 Query only		Specifies the block data for the X axis of the limit curves.	2.9.1.3 No manual control
<b>CALCulate:LIMIT:LOWER:CONTROL:POINTS?</b>	<n> Query only		Returns the number of currently available block data for the X axis of the limit curves.	2.9.1.3 No manual control
<b>CALCulate:LIMIT:FAIL?</b>	Query only		Returns ON if Lim Upper values are exceeded or Lim Lower values are not attained, otherwise OFF. 	2.9.1.3 No manual control
<b>CALCulate:LIMIT:REPORT[:DATA]?</b>	<n>{,<n>}Query only		Returns the block data of limit violations. Corresponds to the contents of a Limit Report file as described in section 2.9.1.2 Loading and Storing of Series of Measured Values and Block/List Data	2.9.1.3 No manual control
<b>CALCulate:LIMIT:REPORT:POINTS?</b>	<n> 0 to 1023 Query only		Returns the number of currently available block data of limit violations.	2.9.1.3 No manual control

Command	Parameter	Basic unit	Meaning	Section
<b>TRACe[:DATA]</b>	<b>TRACe1, &lt;n&gt;{,&lt;n&gt;}</b> Query: TRACe? TRACe1	1)	Specifies the block data of the first measurement sequence (Y1 axis).	2.9.1.3 No manual control
<b>TRACe:POINts?</b>	<b>TRACe1</b> Query only Query: TRAC:POIN? TRAC1 Query reply <n> = 0 to 1023		Returns the number of currently available block data of the first measurement sequence (Y1 axis).	2.9.1.3 No manual control
<b>TRACe[:DATA]</b>	<b>TRACe2, &lt;n&gt;{,&lt;n&gt;}</b> Query: TRACe? TRACe2	1)	Specifies the block data of the second measurement sequence (Y2 axis).	2.9.1.3 No manual control
<b>TRACe:POINts?</b>	<b>TRACe2,</b> Query only Query: TRAC:POIN? TRAC2 Query reply <n> = 0 to 1023 Query only		Returns the number of the currently available block data of the second measurement sequence (Y2 axis).	2.9.1.3 No manual control
<b>TRACe[:DATA]</b>	<b>LIST1, &lt;n&gt;{,&lt;n&gt;}</b> Query: TRACe? LIST1	2)	Specifies the block data of the first sweep list (X axis).	2.9.1.3 No manual control
<b>TRACe:POINts?</b>	<b>LIST1 &lt;n&gt;</b> Query only Query: TRAC:POIN? LIST1 Query reply <n> = 0 to 1023 Query only		Returns the number of the currently available block data of the first sweep list (X axis).	2.9.1.3 No manual control
<b>TRACe[:DATA]</b>	<b>LIST2, &lt;n&gt;{,&lt;n&gt;}</b> Query: TRACe? LIST2	2)	Specifies the block data of the second (convoluted, nested) sweep list (Z axis).	2.9.1.3 No manual control

Command	Parameter	Basic unit	Meaning	Section
<b>TRACe:POINts?</b>	<b>LIST2</b> Query only Query: TRAC:POIN? LIST2 Query reply <n> = 0 to 1023		Returns the number of the currently available block data of the second (convoluted, nested) sweep list (Z axis).	2.9.1.3 <b>No manual control</b>
<b>TRACe[:DATA]</b>	<b>REFERENCE1,&lt;n&gt;{,&lt;n &gt;}</b> Query: TRACe? REF1		Loads the running reference values for the Y axis.	2.9.1.3 <b>No manual control</b>
<b>TRACe:POINts?</b>	<b>REFERENCE1</b> Query only Query: TRAC:POIN? REF1 Query reply <n> = 0 to 1023		Returns the number of the currently available block data for the Y axis of trace A.	2.9.1.3 <b>No manual control</b>
<b>TRACe[:DATA],</b>	<b>REFERENCE2,&lt;n&gt;{,&lt;n &gt;}</b> Query: TRACe? REF2		Loads the running reference values for the Y axis of trace B	2.9.1.3 <b>No manual control</b>
<b>TRACe:POINts?</b>	<b>REFERENCE2</b> Query only Query: TRAC:POIN? REF2 Query reply <n> = 0 to 1023		Returns the number of the currently available block data for the Y axis of trace B.	2.9.1.3 <b>No manual control</b>
<b>TRACe[:DATA],</b>	<b>CREference1,&lt;n&gt;{,&lt;n &gt;}</b> Query: TRACe? CREF1		Loads the running reference values for the X axis of trace A.	2.9.1.3 <b>No manual control</b>

Command	Parameter	Basic unit	Meaning	Section
<b>TRACe:POINts?</b>	<b>CREference1</b> Query only Query: TRAC:POIN? CREF1 Query reply <n> = 0 to 1023		Returns the number of the currently available block data for the X axis of trace A.	2.9.1.3 <b>No manual control</b>
<b>TRACe[:DATA]</b>	<b>CREference2,&lt;n&gt;{,&lt;n&gt; n}&gt;</b> Query: TRACe? CREF2		Loads the running reference values for the X axis of trace B	2.9.1.3 <b>No manual control</b>
<b>TRACe:POINts?</b>	<b>CREference2</b> Query only Query: TRAC:POIN? CREF2 Query reply <n> = 0 to 1023		Returns the number of the currently available block data for the X axis of trace B.	2.9.1.3 <b>No manual control</b>

- 1) Depending on DISPLAY:TRACe:FEED and (with SENSE1:DATA) of SENSE1:FUNCTION
- 2) Depending on sweep selected for generator and analyzer.

## 3.10.11 Commands for Status and Error Queries

Command	Parameter	Basic unit	Meaning	Section
<b>STATUS:PRESet</b>			Resets the Enable registers of the OPERation, QUESTIONable and XQUESTIONable registers to 0. See 3.7.5 Resetting the Status Reporting Systems.	3.7.5 <b>No manual control</b>
<b>STATUS:OPERation:COND?</b>	Query only		Outputs the contents of the CONDITION register as a decimal number (current value of Operating Status of UPL). For the weighting of the individual bits see 3.7.3.4 STATUS:OPERation Register Reading out does not clear the register.	3.7.3.4 <b>No manual control</b>
<b>STATUS:OPERation[:EVENT]?</b>	Query only		Outputs the content of the EVENT register as a decimal number. A bit set in the EVENT register indicates a change of the corresponding bit in the CONDITION register. The entry in the PTRansition and NTRansition registers determines whether a bit transition from 0 to 1 or from 1 to 0 causes an entry in the EVENT register. Reading out clears the register!	3.7.3.4 <b>No manual control</b>
<b>STATUS:OPERation:ENABLE</b>	<p>&lt;n&gt;</p> <pre> ... 0 0 1 0 0 1 0 0 ...  -----  ...d7 d6 d5 d4 d3 d2 d1 d0 </pre> <p>Example: d2 and d5 set: &lt;n&gt; = 36 (4 + 32)</p>		Sets the ENABLE mask which validates a bit in the EVENT register. Example: When d5 is set in the ENABLE mask, the "Waiting for Trigger" event is set in the EVENT register provided the bit has changed. Default setting: every bit reset (0)	3.7.3.4 <b>No manual control</b>
<b>STATUS:OPERation:PTRansition</b>	<n>		If a bit is set in the PTRansition register, the transition from 0 to 1 of the corresponding bit in the CONDITION register causes 1 to be entered in the corresponding bit of the EVENT register provided the corresponding bit in the ENABLE mask is set. Default setting: every bit reset (65535 or 0xFFFF)	3.7.3.4 <b>No manual control</b>
<b>STATUS:OPERation:NTRansition</b>	<n>		If a bit is set in the NTRansition register, a transition from 1 to 0 of the corresponding bit in the CONDITION register causes 1 to be entered in the corresponding bit of the EVENT register provided the corresponding bit in the ENABLE mask is set. Default setting: every bit reset (65535 or 0xFFFF)	3.7.3.4 <b>No manual control</b>



Command	Parameter	Basic unit	Meaning	Section
<b>STATUS:QUESTIONABLE:COND?</b>	Query only		Outputs the status of the CONDITION register (current value of Questionable Status of UPL) as a decimal number. For the weighting of the individual bits see 3.7.3.5 STATUS:QUESTIONABLE Register. Reading out does not clear the register.	3.7.3.5 <b>No manual control</b>
<b>STATUS:QUESTIONABLE[:EVENT]?</b>	Query only		Outputs the contents of the EVENT register as a decimal number. A bit set in the EVENT register indicates a change of the corresponding bit in the CONDITION register. The entry in the PTRANSITION and NTRANSITION registers determines whether a bit transition from 0 to 1 or from 1 to 0 causes an entry in the EVENT register. Reading out clears the register!	3.7.3.5 <b>No manual control</b>
<b>STATUS:QUESTIONABLE:ENABLE</b>	<n>		See above.	3.7.3.5 <b>No manual control</b>
<b>STATUS:QUESTIONABLE:PTRANSITION</b>	<n>		See above.	3.7.3.5 <b>No manual control</b>
<b>STATUS:QUESTIONABLE:NTRANSITION</b>	<n>		See above.	3.7.3.5 <b>No manual control</b>
<b>STATUS:XQUESTIONABLE:COND?</b>	Query only		Outputs the content of the CONDITION register as a decimal number (current value of XQUESTIONABLE Status of UPL). For the weighting of individual bits see 3.7.3.6 STATUS:XQUESTIONABLE Register. Reading out does not clear the register.	3.7.3.6 <b>No manual control</b>
<b>STATUS:XQUESTIONABLE[:EVENT]?</b>	Query only		See above.	3.7.3.6 <b>No manual control</b>
<b>STATUS:XQUESTIONABLE:ENABLE</b>	<n>		See above.	3.7.3.6 <b>No manual control</b>

Command	Parameter	Basic unit	Meaning	Section
<b>STATUS:XQUESTIONable: PTR</b> ansion	<n>		See above.	3.7.3.6 No manual control
<b>STATUS:XQUESTIONable: NTR</b> ansion	<n>		See above.	3.7.3.6 No manual control
<b>SYSTEM:VERSION?</b>	Query only		Returns the number of the associated SCPI version by specifying the year with decimal point and one decimal digit.	2.15.7 No manual control
<b>SYSTEM:ERROR?</b>	Query only		Returns the last error message out of the error message queue. Error messages consist of a number followed by text. Negative error numbers are SCPI-defined, positive numbers are device-specific. If no error occurred, the output is <b>0</b> , " <b>No error</b> ". If the queue gets too long, the error message: <b>-350, "Queue overflow"</b> is output. With *CLS and upon power-on of the device, all error messages are cleared.	3.3.2 No manual control
<b>SYSTEM:COMMunication:GTL</b>			Return to manual operation. This command is only required in the case of remote-control via the RS-232 interface but can also be used for IEC/IEEE-bus operation and Universal Sequence Controller UPL-B10.	LACAL keystroke

## 3.10.12 Commands for Synchronization

Command	Parameter	Basic unit	Meaning	Section
<b>INITiate:CONTinuous</b>	ON OFF		→ Presetting of continuous measurement. → Presetting of a single measurement which is triggered with INITiate[:IMMEDIATE] (see next command).	2.11 <b>START key</b> <b>SINGLE key</b>
<b>INITiate[:IMMEDIATE]</b>			Starts a single measurement. Command INITiate:CONTinuous ON OFF determines whether it is a continuous or a single measurement (see previous command). The two INITiate commands simulate the function of the START or SINGLE key. The following commands are to be entered: START key: INITiate:CONTinuous ON, INITiate[:IMMEDIATE] SINGLE key: INITiate:CONTinuous OFF, INITiate[:IMMEDIATE]	2.11 <b>START key</b> <b>SINGLE key</b>
<b>INITiate:FORCE</b>	<b>START</b> <b>SINGLE</b> <b>STOP</b> <b>CONTinuous</b>		→ A measurement in progress is immediately aborted. • Trailing pointer, average and peak values are reset. • A new continuous measurement is started. (identical with command "INIT:CONT ON") → A measurement in progress is immediately aborted. • A new measurement is started. (identical with command INIT:CONT OFF) → An ongoing measurement is stopped as if the STOP/CONT key was pressed during the measurement (identical with command ABORt ). The measurement is continued with INIT:FORC CONT. → A new continuous measurement is started. • Trailing pointer, average and peak values are <b>not</b> reset.  This is only effective if the measurement was interrupted with INIT:FORC STOP or ABOR or if the measurement was started with INIT:FORC SING or INIT:CONT OFF and completed.	2.11 → <b>Taste START</b> → <b>Taste SINGLE</b> → STOP function of toggle key <b>STOP/CONT</b> → CONT function of toggle key <b>STOP/CONT</b>
<b>INITiate:NEXT</b>	<n>		Has the same effect as turning the spinwheel by <n> steps or pressing the cursor keys (n=1 or n= -1). Makes the next step in the case of a manual sweep or moves the graphics cursor provided the graphics panel is active.	2.11 <b>Spinwheel</b>
<b>ABORt</b>			Stops a measurement as if the STOP/CONT key were actuated during an ongoing measurement. With the command INIT:CONT ON the measurement is resumed.	2.11 <b>STOP/CONT key</b>

3.10.13 Binary Data via IEC/IEEE-Bus Interface

Command	Parameters	Meaning	Section
<b>MMEMory:DATA</b> <le>: <le>: <Binary data>:	'filename', #<le><le><le><le><binary data> Length of subsequent length information of binary data Length of subsequent binary data Any binary codes of any length	If 'filename' contains no path information, the command stores the subsequent binary data in the current working directory of the UPL. The current working directory of the UPL is the directory specified under <code>work_dir</code> in the FILE Panel of the UPL. If 'filename' contains a path that exists in the UPL, the binary data are stored in this path. If 'filename' contains a path that does not exist in the UPL, the error message "Could not write to file" is output. This command therefore allows the transfer of any files of any length from the process controller to the UPL. If a data record to be transferred to the UPL is in the form of a file, its precise length can be determined by means of the DOS command DIR. The value thus obtained is to be specified in the command MMEM:DATA under "Length of subsequent binary data". To allow file transfer from a process controller to the UPL not only for experienced C- and IEC/IEEE-bus programmers, the DOS programs IEC_BT.EXE and UPLMD5.EXE will be supplied with the UPL as from UPL software version 2.0 (see „Initial Steps“, „Transfer of File to UPL“ and following). Example: MMEM:DATA 'MYSETUP.SAC';#48561<any binary data> MMEM:DATA 'UPL\USER\MYSETUP.SAC';#48561<any binary data>	3.10.13 3.17.5 No manual control

Example:

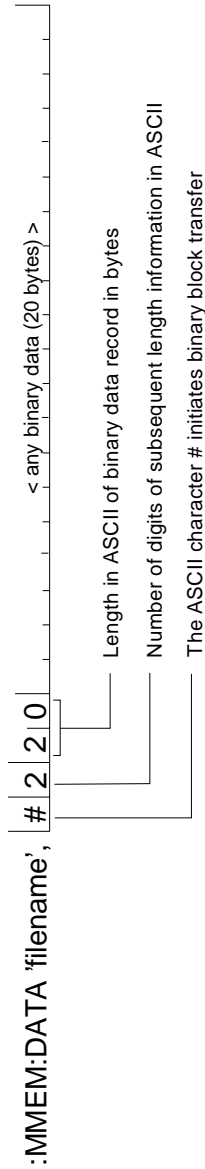

Command	Parameters	Explanation	Section
<b>MEMORY:CHECK?</b>	'filename' Query only	<p>This command determines the MD5 signature of a file. If 'filename' contains no path information, the command determines the MD5 signature of the specified file in the current working directory of the UPL. The current working directory of the UPL is the directory specified under <code>work_dir</code> in the FILE Panel of the UPL.</p> <p>If 'filename' contains a path that exists in the UPL, the MD5 signature of the associated file is determined.</p> <p>If 'filename' contains a path that does not exist in the UPL, the error message "Execution error" is output.</p> <p>A 32-digit signature of the specified file is returned in response to the query. To check whether the contents of a file were transferred error-free from the process controller to the UPL, the MD5 signature method can be used to generate, from the UPL path <code>C:\UPL\IEC_EXAM</code> and prior to the transfer, a digital signature of the file on the process controller using the program <code>UPMD5.EXE</code>. After the transfer of the file to the UPL via the IEC/IEEE bus, a digital signature of the transferred file is generated by means of the command <code>MEMORY:CHECK? 'filename'</code>. If the two signatures agree, it can be assumed that the file contents are identical and the transfer was therefore error-free. Moreover, it can be determined in this way whether any subsequent modifications have been made to a file.</p> <p><b>Example:</b> <code>MEMORY:CHECK, '\UPL\USER\MYSETUP.SAC'</code> Reply (for example): "4edb9481dc7b1fb27393c10c950cf9c1"</p>	3.10.13 3.17.5 <b>No manual control</b>

### 3.10.14 Settings without Corresponding IEC/IEEE-Bus Command

- Setting the contrast for UPL monochrome display
- Selection of remote control in the OPTIONS panel with remote via IEC/COM2

### 3.11 Alphabetical List of IEC/IEEE-Bus Commands

Command	Parameter	Section
<b>ABORt</b>		<b>2.11</b> <b>Taste STOP/CONT</b>
<b>ARM:FREQuency:STARt</b> <b>ARM:FREQuency:STOP</b>	<b>&lt;nu&gt;</b> Value range determined by instrument or function	<b>2.6.4</b> <b>ANLR-Panel</b> Start   Stop
<b>ARM:LEVel:MIN</b>	<b>&lt;nu&gt;</b> Analog instruments 10 mV to 1000 V Digital instrument 1µFS to 1.0 FS	<b>2.6.4</b> <b>ANLR-Panel</b> Min VOLT
<b>ARM:VOLTage:STARt</b> <b>ARM:VOLTage:STOP</b>	<b>&lt;nu&gt;</b> Analog instruments 10 mV to 1000 V Digital instrument 1 mFS to 1.0 FS	<b>2.6.4</b> <b>ANLR-Panel</b> Start   Stop
<b>CALCulate:EQUalize:FEED</b>	<b>TRACe1</b> <b>TRACe2</b>	<b>2.9.1.2</b> <b>FILE-Panel</b> Volt Source → TRACE A → TRACE B
<b>CALCulate:EQUalize:INVert</b>	<b>ON</b> <b>OFF</b>	<b>2.9.1.2</b> <b>FILE-Panel</b> Invert 1/n → ON → OFF
<b>CALCulate:EQUalize:NORMfreq</b>	<b>&lt;nu&gt;</b> $f_{\min}$ to $f_{\max}$	<b>2.9.1.2</b> <b>FILE-Panel</b> Norm Freq
<b>CALCulate:LIMit:FAIL?</b>	<b>&lt;n&gt;</b> Query only	<b>2.10.7</b> <b>keine</b> <b>Handbedienung</b>
<b>CALCulate:LIMit:LOWer:CONTRol:POINts?</b>	<b>&lt;n&gt;</b> Query only	<b>2.9.1.3</b> <b>No manual</b> <b>control</b>
<b>CALCulate:LIMit:LOWer:CONTRol[:DATA]</b>	<b>&lt;n&gt;{,&lt;n&gt;}</b>	<b>2.9.1.3</b> <b>No manual</b> <b>control</b>
<b>CALCulate:LIMit:LOWer:POINts?</b>	<b>&lt;n&gt;</b> 0 to 1023 Query only	<b>2.9.1.3</b> <b>No manual</b> <b>control</b>
<b>CALCulate:LIMit:LOWer:STATe</b>	<b>ON</b> <b>OFF</b>	<b>2.10.7</b> <b>DISP-Panel</b> LIMIT CHECK Mode → LIM LOWER → OFF

Command	Parameter	Section
<b>CALCulate:LIMit:LOWer:TRACe</b>	<n>{,<n>}	2.9.1.3 No manual control
<b>CALCulate:LIMit:LOWer:VALue</b>	<nu>	2.10.7 DISP-Panel Lim Lower → VALUE:
<b>CALCulate:LIMit:LOWer[:DATA]</b>	<n>{,<n>}	2.9.1.3 No manual control
<b>CALCulate:LIMit:ON</b>	TRACe1 TRACe2 TR1And2	2.10.7 DISP-Panel Check → TRACE A → TRACE B → TRACE A+B
<b>CALCulate:LIMit:REPort:POINts?</b>	<n> 0 to 1023 Query only	2.9.1.3 No manual control
<b>CALCulate:LIMit:REPort[:DATA]?</b>	<n>{,<n>} Query only	2.9.1.3 No manual control
<b>CALCulate:LIMit:UPPer:CONTRol:POINts?</b>	<n> 0 to 1023 Query only	2.9.1.3 No manual control
<b>CALCulate:LIMit:UPPer:CONTRol[:DATA]</b>	<n>{,<n>}	2.9.1.3 No manual control
<b>CALCulate:LIMit:UPPer:POINts?</b>	<n> 0 to 1023 Query only	2.9.1.3 No manual control
<b>CALCulate:LIMit:UPPer:STATe</b>	ON OFF	2.10.7 DISP-Panel LIMIT CHECK Mode → LIM UPPER Mode → OFF
<b>CALCulate:LIMit:UPPer:TRACe</b>	<n>{,<n>}	2.9.1.3 No manual control
<b>CALCulate:LIMit:UPPer:VALue</b>	<nu>	2.10.7 DISP-Panel Lim Upper → VALUE:
<b>CALCulate:LIMit:UPPer[:DATA]</b>	<n>{,<n>}	2.9.1.3 No manual control

Command	Parameter	Section
<b>CALCulate:TRANSform:FREQUency:AVERAge</b>	<n> 1 to 256	<b>2.6.5.12</b> <b>ANLR-Panel</b> Average
<b>CALCulate:TRANSform:FREQUency:AVERAge:TCON</b> trol	<b>NORMAL</b> <b>EXPONential</b>	<b>2.6.5.12</b> <b>ANLR-Panel</b> Avg Mode → NORMAL → EXPONENTIAL
<b>CALCulate:TRANSform:FREQUency:CENTer</b>	<nu> Value range determined by instrument or function	<b>2.6.5.12</b> <b>ANLR-Panel</b> Center
<b>CALCulate:TRANSform:FREQUency:FFT</b>	<b>S256</b> <b>S512</b> <b>S1K</b> <b>S2K</b> <b>S4K</b> <b>S8K</b>	<b>2.6.5.12</b> <b>ANLR-Panel</b> FFT Size → 256 → 512 → 1024 → 2048 → 4096 → 8192
<b>CALCulate:TRANSform:FREQUency:MTIME?</b>	<nu> Query only	<b>2.6.5.12</b> <b>ANLR-Panel</b> Meas Time
<b>CALCulate:TRANSform:FREQUency:RESolution?</b>	<nu> Query only	<b>2.6.5.12</b> <b>ANLR-Panel</b> Resolution
<b>CALCulate:TRANSform:FREQUency:SPAN?</b>	<nu> Query only	<b>2.6.5.12</b> <b>ANLR-Panel</b> Span
<b>CALCulate:TRANSform:FREQUency:START?</b> <b>CALCulate:TRANSform:FREQUency:STOP?</b>	<nu> Query only	<b>2.6.5.12</b> <b>ANLR-Panel</b> Start / Stop
<b>CALCulate:TRANSform:FREQUency:STATe</b>	<b>OFF</b> <b>ON</b>	<b>2.6.5.1</b> <b>ANLR-Panel</b> POST FFT → OFF → ON
<b>CALCulate:TRANSform:FREQUency:WINDow</b>	<b>RECTangular</b> <b>HANNing</b> <b>BLACKman_harris</b> <b>RIF1</b> <b>RIF2</b> <b>RIF3</b> <b>HAMMING</b> <b>FLATtop</b> <b>KAISer</b>	<b>2.6.5.12</b> <b>ANLR-Panel</b> Window → RECTANG... → HANN → BLACKMAN H → RIFE VINC 1 → RIFE VINC 2 → RIFE VINC 3 → HAMMING → FLAT TOP → KAISER



Command	Parameter	Section
<b>CALC</b> ulate: <b>TRANS</b> form: <b>FREQU</b> ency: <b>WIND</b> ow: <b>BETA</b> f actor	<n> = 1 to 20	<b>2.6.5.12</b> <b>ANLR-Panel</b> β-Factor
<b>CALC</b> ulate: <b>TRANS</b> form: <b>FREQU</b> ency: <b>ZOOM</b>	<n> 1 to 128 for iInstrument A22 u. D48: n = 1,2,4,8,16,32,64,128 A110: n = 1,2,4,8,16 n = 1: <b>Zooming aus</b>	<b>2.6.5.12</b> <b>ANLR-Panel</b> Zoom-FFT
<b>CAL</b> ibrate	<b>OFF</b> Equivalent to CAL:ZERO:AUTO OFF <b>AUTO</b> Equivalent to CAL:ZERO:AUTO ON <b>DCC</b> Equivalent to CAL:ZERO:AUTO ONCE <b>LDG</b> Equivalent to CAL LDG:AUTO ONCE	2.15.6
<b>CAL</b> ibrate: <b>JIT</b> Ter: <b>AUTO</b>	<b>OFF</b> <b>ONCE</b>	<b>2.15.6</b> <b>OPTIONS-Panel</b> CALIBR. DIG PhaseToRef → OFF → ONCE
<b>CAL</b> ibrate: <b>LDG</b> : <b>AUTO</b>	<b>OFF</b> <b>ONCE</b>	<b>2.15.6</b> <b>OPTIONS-Panel</b> CALIBR. GEN Low Dist → OFF → ONCE
<b>CAL</b> ibrate: <b>ZERO</b> : <b>AUTO</b>	<b>OFF</b> <b>ON</b> <b>ONCE</b>	<b>2.15.6</b> <b>OPTIONS-Panel</b> CALIBR. ANL Zero Auto → OFF → ON → ONCE
<b>CON</b> Figure: <b>DAI</b>	<b>BRM</b> <b>HRM</b>	<b>2.15.9</b> <b>OPTIONS-Panel</b> Sampl Mode → BASE RATE → HIGH RATE
<b>DIS</b> Play: <b>ACT</b> ualize	<b>ON</b> <b>OFF</b>	<b>No manual control</b>

Command	Parameter	Section
<b>DISPlay:ANNOtation[:ALL]</b>	<b>ON</b> <b>OFF</b>	<b>2.15.5</b> <b>OPTIONS-Panel</b> Meas Disp → ON → OFF Ext. Keyboard: CTRL D
<b>DISPlay:CONFIguration</b>	<b>P</b> <b>SP</b> <b>AP</b> <b>GP</b> <b>FP</b> <b>DP</b> <b>OP</b> <b>GAT</b> <b>GAO</b> <b>GAD</b> <b>FAT</b> <b>FAO</b> <b>FAD</b> <b>SHON</b> <b>SHOFF</b>	<b>2.3.1</b>  Keys      Ext. UPL keyboar d _____  GEN      ALT+G ANLR     ALT+A FILT     ALT+T FILE     ALT+F DISP     ALT+D GRAPH    ALT+R ZOOM     ALT+Z SHOW I/O ALT+I OPTIONS ALT+O
<b>DISPlay:MODE</b>	<b>INTern</b> <b>COLBoth</b> <b>BWBoth</b> <b>AUTO</b>	<b>2.15.5</b> <b>OPTIONS-Panel</b> Extrn Disp → INTERN ONLY → BOTH COLOR → BOTH B/W → BOTH AUTO
<b>DISPlay:PROTOcol:CHStatus?</b>	Query only Response:: <b>NO</b> <b>LTC</b> <b>YES</b>	<b>2.10.8</b> <b>GRAPH-Panel</b> <b>Display</b>
<b>DISPlay:PROTOcol:ERRor:GENeral?</b>	Query only Response:: <b>UBB</b> <b>SQB</b> <b>NSYN</b> <b>PRMB</b> <b>SQLR</b> <b>RERR</b> <b>NONE</b>	<b>2.10.8</b> <b>GRAPH-Panel</b> <b>Display</b>
<b>DISPlay:PROTOcol:ERRor:LCRC?</b>	<n> Query only	<b>2.10.8</b> <b>GRAPH-Panel</b> <b>Display</b>
<b>DISPlay:PROTOcol:ERRor:PARity?</b>	<n> Query only	<b>2.10.8</b> <b>GRAPH-Panel</b> <b>Display</b>
<b>DISPlay:PROTOcol:ERRor:RCRC?</b>	<n> Query only	<b>2.10.8</b> <b>GRAPH-Panel</b> <b>Display</b>

Command	Parameter	Section
<b>DISPlay:PROTOcol:FORMat</b>	<b>BIN</b> ary <b>HEX</b> adecimal <b>ASCii</b> <b>FILE</b>	<b>2.10.8</b> <b>DISP-Panel</b> Format → BIN → HEX → ASCII → FILE DEF
<b>DISPlay:PROTOcol:LR?</b>	Query only Response: <b>EQUAL</b> <b>DIFF'</b>	<b>2.10.8</b> <b>GRAPH-Panel</b> <b>Display</b>
<b>DISPlay:PROTOcol:LVALbit?</b>	Query only Response: <b>Y0</b> <b>N1</b>	<b>2.10.8</b> <b>GRAPH-Panel</b> <b>Display</b>
<b>DISPlay:PROTOcol:RVALbit?</b>	Query only Response:: <b>Y0</b> <b>N1</b>	<b>2.10.8</b> <b>GRAPH-Panel</b> <b>Display</b>
<b>DISPlay:PROTOcol:SElect</b>	<b>LCH</b> annelstatus <b>RCH</b> annelstatus <b>LUS</b> erdata <b>RUS</b> erdata	<b>2.10.8</b> <b>DISP-Panel</b> Source → CHAN STAT L → CHAN STAT R → USER DATA L → USER DATA R
<b>DISPlay[:WINDow]:TEXT:LOCate</b>	<ny>,<nx>]	<b>2.10.1</b> <b>DISP-Panel</b> X Pos, Y Pos
<b>DISPlay[:WINDow]:TEXT[:DATA]</b>	'string'	<b>2.10.1</b> <b>DISP-Panel</b> COMMENT
<b>DISPlay[:WINDow]:TRACe:X:LABel</b>	'string'	<b>2.10.2</b> <b>DISP-Panel</b> Unit/Label
<b>DISPlay[:WINDow]:TRACe[]:AUToscale</b> alias <b>AUTOs</b> cale		<b>2.10.2</b> <b>Softkey</b> F7 (AUTOSCALE) → F6 (ALL)
<b>DISPlay[:WINDow]:TRACe[]:COUNT</b>	<n> recorded: 1 to 100,000 stored: 17 traces max.	<b>2.10</b> <b>DISP-Panel</b> Scan Count
<b>DISPlay[:WINDow]:TRACe[]:CURSor[]:DATA1?</b> <b>DISPlay[:WINDow]:TRACe[]:CURSor[]:DATA2?</b> <b>DISPlay[:WINDow]:TRACe[]:CURSor[]:DATA3?</b>	Query only	<b>2.10.2</b> <b>Display in</b> <b>graphics window</b>

Command	Parameter	Section
<b>DISPlay[:WINDow]:TRACe[:CURSor[1]:MODE</b>	N12 D12 OFF	<b>2.10.2</b> <b>Softkey</b> F8: sel. O-CURS. F9: (O-CURS) → F6 (A,B) → F7 (A-B) → F11 (ON/OFF)
<b>DISPlay[:WINDow]:TRACe[:CURSor[1 2]</b>	ACTive	<b>2.10.2</b> <b>DISP-Panel</b> Softkey level 1 F8
<b>DISPlay[:WINDow]:TRACe[:CURSor[1 2]:POSITION</b>	<nu>	<b>2.10.2</b> nicht über Softkey bedienbar
<b>DISPlay[:WINDow]:TRACe[:CURSor[1 2]:POSITION:MODE</b>	MIN1 MIN2 I MAX1 MAX1 I MAX2 MAX2 MARKer1 NEXTmarker VALue	<b>2.10.2</b> <b>Softkey</b> F8 sel. O-CURS or *-CURS. → F10 (SET TO) → ---- → ---- → F6 (I MAX A) → F7 (MAX A) → F8 (I MAX B) → F9 (MAX B) → F10 (MARKER) → F11 (NXT HARM)
<b>DISPlay[:WINDow]:TRACe[:CURSor2:MODE</b>	N12 D12 C12 HL1 HL2 HLD1 HLD2 OFF	<b>2.10.2</b> <b>Softkey</b> F8 sel. O-CURS F9 sel. *-CURSOR → F6 (A,B) → F7 (A-B) → F8 (* - O) → F9 (HLINE) → A → F9 (HLINE) → B → F9 (HLINE) → ΔA → F9 (HLINE) → ΔB → F11 (ON/OFF)
<b>DISPlay[:WINDow]:TRACe[:INDEX</b>	<n> 1 to 17	<b>2.9.3.3</b> <b>Tasten</b> PAGE UP / PAGE DOWN
<b>DISPlay[:WINDow]:TRACe[:LABEL</b>	ON OFF	<b>2.10.2</b> <b>DISP-Panel</b> User Label → ON → OFF

Command	Parameter	Section
<b>DISPlay[:WINDow]:TRACe[]:MODE</b>	<b>DELeTe_bef_wr</b> <b>WATERfall CASCade</b> <b>MAXHold</b>	<b>2.10</b> <b>DISP-Panel</b> Mode → DEL BEF WR → WATERFALL → MAX HOLD
<b>DISPlay[:WINDow]:TRACe[]:OPERation</b>	<b>CURVeploT</b> <b>LIST</b> alias <b>TLISt</b> <b>ERRors</b> <b>BARGraph</b> <b>SPECtrum</b> <b>FFTLISt</b> <b>FFTErrors</b> <b>PROTOcol</b> <b>AUTOprotocol</b> alias <b>AUTOprotocol</b>	<b>2.10</b> <b>DISP-Panel</b> OPERATION → CURVE PLOT <b>2.10.2</b> → SWEEP LIST <b>2.10.4</b> → SWP LIM REP <b>2.10.4</b> → BARGRAPH <b>2.10.2</b> → SPECT LIST <b>2.10.8</b> → SPC LIM REP <b>2.10.6</b> PROTOCOL <b>2.10</b> <b>2.10.8</b> → PROTO AUTO
<b>DISPlay[:WINDow]:TRACe[]:X:SPACing</b>	<b>LINear</b> <b>LOGarithmic</b>	<b>2.10.1</b> <b>DISP-Panel</b> Spacing → LIN → LOG
<b>DISPlay[:WINDow]:TRACe[]:X[:SCALE]:AUTO</b>	<b>ON</b> <b>OFF</b>	<b>2.10.1</b> <b>DISP-Panel</b> Scale → AUTO → MANUAL or Softkey F7 (AUTOSCALE) → F9 (X)
<b>DISPlay[:WINDow]:TRACe[]:X[:SCALE]:LEFT</b> <b>DISPlay[:WINDow]:TRACe[]:X[:SCALE]:RIGHT</b>	<b>&lt;nu&gt;</b>	<b>2.10.1</b> <b>DISP-Panel</b> Left Right
<b>DISPlay[:WINDow]:TRACe[]:X[:SCALE]:RLEVel</b>	<b>&lt;nu&gt;</b>	<b>2.10.1</b> <b>DISP-Panel</b> Reference → VAQLUE
<b>DISPlay[:WINDow]:TRACe[]:X[:SCALE]:UNIT</b>	<b>V</b> <b>Hz</b> <b>s</b> and so on see <b>3.10.4 Units</b> for IEC Measurement Results	<b>2.10.1</b> <b>DISP-Panel</b> Unit

Command	Parameter	Section
<b>DISPlay[:WINDow]:TRACe[]:Y:AUTO</b>	<b>ONCE OFF</b>	<b>2.10.2 DISP-Panel</b> Scale → AUTO ONCE → MANUAL  ONCE via Softkey F7 (AUTOSCALE) → F7 (A) → F8 (B)
<b>DISPlay[:WINDow]:TRACe[]:Y[:SCALE]:RLEVel</b>	<nu>	<b>2.10.1 DISP-Panel</b> Reference → VALUE
<b>DISPlay[:WINDow]:TRACe[]:Y[:SCALE]:UNIT</b>	<u> see 3.10.4 Units for IEC Measurement Results	<b>2.10.1 DISP-Panel</b> Unit
<b>DISPlay[:WINDow]:TRACe[]:ZOOM</b>	<n> <b>0</b> <b>1</b> <b>-1</b> <b>2</b> <b>3</b> <b>4</b>	<b>2.10.2 Softkey</b> F10 (ZOOM) → F10 (UNZOOM) → F6 (AT o UP) → F7 (AT o DOWN) → F8 (CEN TO o) → F9 (o TO *) → F11 (UNDO)
<b>DISPlay[:WINDow]:TRACe[1]:Y:LABel</b>	'string'	<b>2.10.2 DISP-Panel</b> Unit/Label
<b>DISPlay[:WINDow]:TRACe[1 2]:CURVe</b>	<b>OFF ON</b>	<b>2.10.2 Softkey</b> → F6 (CURVE) → F6 (A ON/OFF) → F7 (B ON/OFF)
<b>DISPlay[:WINDow]:TRACe[1 2]:FEED</b>	'SENSE1:DATA1' 'SENSE1:DATA2' 'SENSE2:DATA1' 'SENSE2:DATA2' 'SENSE3:DATA1' 'SENSE3:DATA2' 'HOLD' 'FILE' 'DFILE' 'OFF'	<b>2.10.1 DISP-Panel</b> TRACE A/B → FUNC CH1 → FUNC CH2 → INP RMS CH1 → INP RMS CH2 → FREQ CH1 → FREQ CH2 → PHASE → GROUP DEL → HOLD → FILE → DUAL FILE → OFF

Command	Parameter	Section
<b>DISPlay[:WINDow]:TRACe[1 2]:MARKer:HARMOnics</b>	<b>ON</b> <b>OFF</b>	<b>2.10.2</b> <b>Softkey</b> F11 (MARKER) F6 (TRACE A) or F7 (TRACE B) selects → F10 (HARM) on/off
<b>DISPlay[:WINDow]:TRACe[1 2]:MARKer:MODE</b>	<b>MAXimum</b> <b>CURSOr</b> <b>OFF</b>	<b>2.10.2</b> <b>Softkey</b> F11 (MARKER) F6 (TRACE A) or F7 (TRACE B) selects → MAX → CURSOR → VIEW OFF
<b>DISPlay[:WINDow]:TRACe[1 2]:Y:SPACing</b>	<b>LINear</b> <b>LOGarithmic</b>	<b>2.10.1</b> <b>DISP-Panel</b> Spacing → LIN → LOG
<b>DISPlay[:WINDow]:TRACe[1 2]:Y[:SCALe]:AUTO</b>	<b>ONCE</b> <b>OFF</b>	<b>2.10.1</b> <b>DISP-Panel</b> Scale → AUTO ONCE → MANUAL
<b>DISPlay[:WINDow]:TRACe[1 2]:Y[:SCALe]:BOTTom</b>	<b>&lt;nu&gt;</b>	<b>2.10.1</b> <b>DISP-Panel</b> Bottom
<b>DISPlay[:WINDow]:TRACe[1 2]:Y[:SCALe]:NORMAlize</b>	<b>&lt;nu&gt;</b> 10 <sup>-12</sup> to 10 <sup>6</sup> or -200 dB to 120 dB	<b>2.10.1</b> <b>DISP-Panel</b> Normalize
<b>DISPlay[:WINDow]:TRACe[1 2]:Y[:SCALe]:NORMAlize:MODE</b>	<b>CURSOr[1]</b> (o-Cursor) <b>CURSOr2</b> (*-Cursor) <b>VALue</b>	<b>2.10.1</b> <b>DISP-Panel</b> Normalize → o-Cursor → *-Cursor → VALue

Command	Parameter	Section
<b>DISPlay[:WINDow]:TRACe[1 2]:Y[:SCALe]:RLEVel:MODE</b>	VALue MAXimum CURSor[1] CURSor 2 FILE HOLD OTRAce CH1Meas CH2Meas GENTrack IFILe REF997 REF1000	<b>2.10.1</b> <b>DISP-Panel</b> Reference → VALUE → MAX → oCURSOR → *CURSOR → FILE → HOLD → OTHER TRACE → MEAS CH1 → MEAS CH2 → GEN TRACK → FILE INTERN → REF 997 Hz → REF 1000 Hz
<b>DISPlay[:WINDow]:TRACe[1 2]:Y[:SCALe]:TOP</b>	<nu>	<b>2.10.1</b> <b>DISP-Panel</b> Top
<b>DISPlay[:WINDow]:TRACe2:Y:LABel</b>	'string'	<b>2.10.2</b> <b>DISP-Panel</b> Unit/Label
<b>DISPlay[:WINDow]:TRACe2:Y[:SCALe]:EQUAL</b>	ON OFF	<b>2.10.1</b> <b>DISP-Panel</b> Scale B → EQUAL A → NOT EQUAL A
<b>FORMat[:DATA]</b>	ASCLi REAL	<b>No manual control</b>
<b>HCOPy:ABORt</b>		<b>2.14</b> <b>Taste H COPY</b> or CTRL F8



Command	Parameter	Section
<b>HCOPY:DESTination</b>	PRSPc alias PRINter PLHPgl alias PLOTter PRPS PRHPgl  FIPCx, 'filename.PCX' alias PCXFile, 'name.PCX'  FIHPgl, 'filename.GL' alias HPGLfile, 'name.GL'  FIPS, 'filename.PS' FIEPs, 'filename.EPS'  Query response: PRIN PLOT PRHP PRPS PCXF HPGL FIPS FIEP	<b>2.14</b> <b>OPTIONS-Panel</b> Destin (Ziel/Format) → PRINTR/SPC → PLOTTR/HPGL → PRINTR/HPGL → PRINTR/PS → FILE/PCX → FILE/HPGL → FILE/PS → FILE/EPS
<b>HCOPY:DEVIce:COLor</b>	<b>ON</b> <b>OFF</b>	<b>2.14</b> <b>OPTIONS-Panel</b> COLOR → ON → OFF
<b>HCOPY:DEVIce:PRINter</b>	<n>	<b>2.14</b> <b>OPTIONS-Panel</b> Printname
<b>HCOPY:DEVIce:RESolution</b>	<b>HIGH</b> <b>MEDIum</b> <b>LOW</b>	<b>2.14</b> <b>OPTIONS-Panel</b> Prn Resol → HIGH → MEDIUM → LOW
<b>HCOPY:ITEM</b>	<b>ALL</b> <b>GRATicule</b> <b>TRACe</b>	<b>2.14</b> <b>OPTIONS-Panel</b> Copy → SCREEN → CURVE/GRID → CURVE
<b>HCOPY:ITEM:FRAME</b>	<b>WHITe</b> <b>FDEFined</b>	<b>2.14</b> <b>OPTIONS-Panel</b> Frame → WHITE → FILE DEF

Command	Parameter	Section
HCOPY:ITEM:LABEL:STATE	ON OFF	2.14 Taste H COPY or Ctrl F8
HCOPY:PAGE:LENGTH?	<n> Query only	2.14 OPTIONS-Panel Prn Height
HCOPY:PAGE:LMARGIN	<n> 0 to 80	2.14 OPTIONS-Panel LEFT MRGN
HCOPY:PAGE:ORIENTATION	LANDscape PORTrait	2.14 OPTIONS-Panel ORIENTATION → LANDSCAPE → PORTRAIT
HCOPY:PAGE:SCALE:X	<n> 0.1 to 10	2.14 OPTIONS-Panel X-SCALING
HCOPY:PAGE:SCALE:Y	<n> 0.1 to 10	2.14 OPTIONS-Panel Y-SCALING
HCOPY:PAGE:WIDTH?	<n> Query only	2.14 OPTIONS-Panel Prn Width,
HCOPY:PLADDRESS	<n> 0 to 31	2.14 OPTIONS-Panel → IEC Adr
HCOPY:PLOTS	<n> 1 to 6	2.14 OPTIONS-Panel Plots/Page
HCOPY:PLPORT	COM2 LPT1 IEC	2.14 OPTIONS-Panel Plot on → COM 2 → LPT 1 → IEC BUS
HCOPY:SIZE	A4 LETTER	2.14 OPTIONS-Panel Paper Size → A4 → LETTER
HCOPY:WAIT		2.14 No manual control
HCOPY[:IMMEDIATE]	CNF CF NCNF NCF CONFIG	2.14 Taste H COPY or CTRL F8

Command	Parameter	Section
<b>INITiate:CONTinuous</b>	<b>ON</b> <b>OFF</b>	<b>2.11</b> <b>Taste START</b> <b>Taste SINGLE</b>
<b>INITiate:FORCe</b>	<b>START</b> <b>SINGle</b> <b>STOP</b> <b>CONTinuous</b>	<b>2.11</b> → <b>Taste START</b> → <b>Taste SINGLE</b> → STOP function of toggle key <b>STOP/CONT</b> → CONT function of toggle key <b>STOP/CONT</b>
<b>INITiate:NEXT</b>	<b>&lt;n&gt;</b>	<b>2.11</b> <b>Drehrad</b>
<b>INITiate[:IMMediate]</b>		<b>2.11</b> <b>Taste START</b> <b>Taste SINGEL</b>
<b>INPut:FILTer[:LPASs]:FREQUency</b>	<b>&lt;n&gt;</b> Query only <b>10 Hz</b>   <b>20 Hz</b>	<b>2.6.1</b> <b>ANLR-Panel</b> Min Freq
<b>INPut[]:AUDiobits</b>	<b>&lt;n&gt;</b> Value range see 2.6.3 Configuration of the Digital Analyzer	<b>2.6.3</b> <b>ANLR-Panel</b> Audio Bits
<b>INPut[]:SAMPle:FREQUency</b>	<b>&lt;nu&gt;</b> Opt. UPL-B2 (Digital Audio I/O) 27 kHz to 55 kHz Opt. UPL-B29 im Base Rate Mode 40 kHz to 55 kHz Opt. UPL-B29 im High Rate Mode 40 kHz to 106 kHz	<b>2.6.3</b> <b>ANLR-Panel</b> Sample Frq → VALUE:
<b>INPut[]:SAMPle:FREQUency:MODE</b>	<b>F32</b> <b>F44</b> <b>F48</b> <b>F88</b> <b>F96</b> <b>VALue</b> <b>AUTO</b> <b>CHStatus</b>	<b>2.6.3</b> <b>ANLR-Panel</b> Sample Frq → 32 kHz → 44.1 kHz → 48 kHz → 88.2 kHz → 96.0 kHz → VALUE: → AUTO → CHAN STATUS
<b>INPut[]:SELEct</b>	<b>CH1</b> <b>CH2</b> <b>CH1And2</b> <b>CH1Is2</b> <b>CH2Is1</b> <b>BOTH</b>	<b>2.6.2</b> <b>2.6.3</b> <b>ANLR-Panel</b> CHANNEL(s) → 1 → 2 → 1 & 2 → 1 ≡ 2 → 2 ≡ 1 → BOTH

Command	Parameter	Section
<b>INPut[1 2]:COUPling</b>	AC DC	<b>2.6.2</b> <b>ANLR-Panel</b> CH1 Coupl CH2 Coupl → AC → DC
<b>INPut[1 2]:IMPedance</b>	R300 R600 R200K	<b>2.6.2</b> <b>ANLR-Panel</b> Imped → 300 Ω → 600 Ω → 200 kΩ
<b>INPut[1 2]:LOW</b>	FLOat GROund	<b>2.6.2</b> <b>ANLR-Panel</b> Common → FLOAT → GROUND
<b>INPut[1 2]:TYPE</b>	BALanced GEN1 GEN2 AESebu SPDif OPTical INTern	<b>2.6.2</b> <b>2.6.3</b> <b>ANLR-Panel</b> Input → BAL XLR → GEN1 → GEN2 → GEN CROSSED → BAL (XLR) → UNBAL (XLR) → OPTICAL → INTERN
<b>INSTrument[1]:NSElect</b>	1 3	<b>2.5.1</b> <b>GEN-Panel</b> INSTRUMENT → ANALOG → DIGITAL
<b>INSTrument[1]:SElect]</b>	A25 D48	<b>2.5.1</b> <b>GEN-Panel</b> INSTRUMENT → ANALOG → DIGITAL
<b>INSTrument2:NSElect</b>	1 2 4	<b>2.6.1</b> <b>ANLR-Panel</b> INSTRUMENT → ANLG 22 kHz → ANLG 110 kHz → DIGITAL
<b>INSTrument2[:SElect]</b>	A22 A110 D48	<b>2.6.1</b> <b>ANLR-Panel</b> INSTRUMENT → ANLG 22 kHz → ANLG 110 kHz → DIGITAL
<b>MMEMory:CDIRectory</b>	'pathname'	<b>2.9.2</b> <b>FILE-Panel</b> Work Dir

Command	Parameter	Section
<b>MME</b> Mory: <b>CHEC</b> k?	'filename'	<b>3.10.13</b> <b>3.15.20</b> <b>3.17.5</b> keine Handbedienung
<b>MME</b> Mory: <b>COPY</b>	'filename1', 'filename2'	<b>2.9.2</b> <b>FILE-Panel</b> Copy + To
<b>MME</b> Mory: <b>DATA</b>	'filename'	<b>3.10.13</b> <b>3.15.20</b> <b>3.17.5</b> keine Handbedienung
<b>MME</b> Mory: <b>DEL</b> ete	'filename'	<b>2.9.2</b> <b>FILE-Panel</b> Delete
<b>MME</b> Mory: <b>LOAD:LIST</b>	<b>LIM</b> Upper, 'filename' Query-Form MME:LOAD:LIST? LIMU	<b>2.10.7</b> <b>DISP-Panel</b> Lim Upper → FILE + filename
<b>MME</b> Mory: <b>LOAD:LIST</b>	<b>LIM</b> Lower, 'filename' Query-Form MME:LOAD:LIST? LIML	<b>2.10.7</b> <b>DISP-Panel</b> Lim Lower → FILE + filename
<b>MME</b> Mory: <b>LOAD:LIST</b>	<b>EQU</b> alize, 'filename' Query: MME:LOAD:LIST? EQU	<b>2.5.4.3</b> <b>2.5.4.4</b> <b>GEN-Panel</b> Equal File → FILE + filename
<b>MME</b> Mory: <b>LOAD:LIST</b>	<b>ARB</b> bitrary, 'filename' Query: MME:LOAD:LIST? ARB  <b>RAN</b> Dom, 'filename' Query: MME:LOAD:LIST? RAND	<b>2.5.4.9</b> <b>2.5.4.10</b> <b>GEN-Panel</b> Shape File → FILE + filename
<b>MME</b> Mory: <b>LOAD:LIST</b>	<b>DWEL</b> I, 'filename' Query: MME:LOAD:LIST? DWEL	<b>2.5.4.2</b> <b>GEN-Panel</b> Dwell File → FILE + filename
<b>MME</b> Mory: <b>LOAD:LIST</b>	<b>FREQ</b> uency[1 2], 'filename'  Query-Form MME:LOAD:LIST? FREQ[1 2]	<b>2.5.4.2</b> <b>GEN-Panel</b> FREQ FILE → FILE + filename
<b>MME</b> Mory: <b>LOAD:LIST</b>	<b>FREQ</b> uency, 'filename'  Query-Form MME:LOAD:LIST? FREQ	<b>2.6.5.3</b> <b>2.9.1.3</b> <b>ANLR-Panel</b> SWEEP CTRL → FILE + filename

Command	Parameter	Section
<b>MME</b> Mory:LOAD:LIST	<b>INT</b> erval,'filename'  Query: MME:LOAD:LIST? INT	<b>2.5.4.5</b> <b>2.5.4.6</b> <b>GEN-Panel</b> INTV FILE → FILE + filename
<b>MME</b> Mory:LOAD:LIST	<b>ONT</b> ime,'filename'  Query: MME:LOAD:LIST? ONT	<b>2.5.4.5</b> <b>2.5.4.6</b> <b>GEN-Panel</b> ONTIM FILE → FILE + filename
<b>MME</b> Mory:LOAD:LIST	<b>VOLT</b> age[1 2],'filename'  Query: MME:LOAD:LIST? VOLT[1 2]	<b>2.5.4.2</b> <b>GEN-Panel</b> VOLT FILE → FILE + filename
<b>MME</b> Mory:LOAD:LIST	<b>DWEL</b> I2,'filename'  Query: MME:LOAD:LIST? DWEL2	<b>2.5.4.2</b> Sweeps <b>GEN-Panel</b> AUX GEN: Dwell File → FILE + filename
<b>MME</b> Mory:LOAD:LIST	<b>FREQ</b> uency2,'filename'  Query-Form MME:LOAD:LIST? FREQ2	<b>2.5.4.2</b> Sweeps <b>GEN-Panel</b> AUX GEN FREQUENCY FREQ FILE → FILE + filename
<b>MME</b> Mory:LOAD:LIST	<b>VOLT</b> age2,'filename'  Query: MME:LOAD:LIST? VOLT2	<b>2.5.4.2</b> Sweeps <b>GEN-Panel</b> AUX GEN VOLTAGE   AMPL VOLT FILE → FILE + filename
<b>MME</b> Mory:LOAD:LIST	<b>EQU</b> alize,'filename'.  Query: MME:LOAD:LIST? EQU	<b>2.5.4.4</b> <b>GEN-Panel</b> Equal.File → FILE + filename
<b>MME</b> Mory:LOAD:LIST	<b>EQU</b> alize,'filename'  Query form: MME:LOAD:LIST? EQU	<b>2.5.4.1.1</b> <b>GEN-Panel</b> Equal.File
<b>MME</b> Mory:LOAD:LIST SENSE,	'filename'	<b>2.6.5.7</b> <b>2.6.5.12</b> <b>ANL Panel</b> Equal. file
<b>MME</b> Mory:LOAD:LPGC,	'filename'	<b>2.5.3.2</b> <b>GEN-Panel</b> Filename
<b>MME</b> Mory:LOAD:PAC,	'filename'	<b>2.10.8</b> <b>DISP-Panel</b> Proto File

Command	Parameter	Section
<b>MME</b> Mory:LOAD:PAU,	'filename'	<b>2.10.8</b> <b>DISP</b> -Panel Proto File
<b>MME</b> Mory:LOAD:PGU,	'filename'	<b>2.5.3.2</b> <b>GEN</b> -Panel Filename
<b>MME</b> Mory:LOAD:RPGC,	'filename'	<b>2.5.3.2</b> <b>GEN</b> -Panel Filename
<b>MME</b> Mory:LOAD:STATe	0 2 4, 'filename'  Query: MME:LOAD:STAT? 0 MME:LOAD:STAT? 2 MME:LOAD:STAT? 4	<b>2.9.1.1</b> <b>FILE</b> -Panel Mode / Filename
<b>MME</b> Mory:LOAD:TRACe	TRACe[1 2], 'filename'  Query: MME:LOAD:TRAC? TRAC[1 2]	<b>2.10.1</b> <b>DISP</b> -Panel TRACE A/B → FILE + Filename
<b>MME</b> Mory:LOAD:TRACe[1 2]	REFTrace, 'filename'  Query: MME:LOAD:TRAC[1 2]? REFT	<b>2.10.1</b> <b>DISP</b> -Panel Reference → FILE + Reference
<b>MME</b> Mory:STORe:FORMat	<b>BIN</b> <b>ASCii</b> <b>EXP</b> ort	<b>2.9.1.2</b> <b>FILE</b> -Panel Format → REAL → ASCII → EXPORT
<b>MME</b> Mory:STORe:INFOtext	'string'	<b>2.9.1.1</b> <b>FILE</b> -Panel Info Text
<b>MME</b> Mory:STORe:LIST	<b>LIST</b> [1 2], 'filename' <b>DWEL</b> [1 2], 'filename' <b>ERR</b> ors, 'filename' <b>LIM</b> Upper, 'filename' <b>LIM</b> Lower, 'filename' <b>EQU</b> alize, 'filename'  Query: MME:STOR:LIST? LIST[1 2] MME:STOR:LIST? DWEL[1 2] MME:STOR:LIST? LIMU MME:STOR:LIST? LIML MME:STOR:LIST? EQU	<b>2.9.1.2</b> <b>FILE</b> -Panel Store → X-Axis → Z-Axis → DWEL VALUE → LIM REPORT → LIM UPPER → LIM LOWER → EQUALIZATN
<b>MME</b> Mory:STORe:STATe	0 2, 'filename'  Query: MME:STOR:STAT? 0 MME:STOR:STAT? 2	<b>2.9.1.1</b> <b>FILE</b> -Panel Mode / Filename

Command	Parameter	Section
<b>MME</b> MoRY: <b>STOR</b> e: <b>STAT</b> e: <b>RON</b> Ly	<b>ON</b> <b>OFF</b>	<b>2.9.1.1</b> <b>FILE-Panel</b> Attrib → READ ONLY → READ/WRITE
<b>MME</b> MoRY: <b>STOR</b> e: <b>TRAC</b> e	<b>TRAC</b> e[1 2], 'filename' <b>TR1</b> And2, 'filename'  Query: MME:STOR:TRAC? TRAC[1 2] MME:STOR:TRAC? TR1A	<b>2.9.1.2</b> <b>FILE-Panel</b> Store → TRACE A → TRACE B → TRACE A+B
<b>OUT</b> Put	<b>ON</b> <b>OFF</b>	<b>2.13</b> Taste OUTPUT OFF
<b>OUT</b> Put: <b>AUD</b> iobits	<n> = 8 to 24	<b>2.5.3</b> <b>GEN-Panel</b> Audio Bits
<b>OUT</b> Put: <b>DIG</b> ital: <b>CSIM</b> ulator	<b>OFF</b> <b>SIM</b> Long	<b>2.5.3</b> <b>GEN-Panel</b> Cable Sim → OFF → LONG CABLE
<b>OUT</b> Put: <b>DIG</b> ital: <b>REF</b> erence: <b>FEED</b>	<b>AIN</b> Put <b>AIN</b> Reclock <b>AOUT</b> put <b>RGEN</b> erator	<b>2.5.3</b> <b>GEN-Panel</b> Ref Out → AUDIO IN → AUD IN RCLK → AUDIO OUT → REF GEN
<b>OUT</b> Put: <b>DIG</b> ital: <b>SYNC</b> : <b>FEED</b>	<b>AIP</b> ut <b>GCL</b> ock <b>RIN</b> put <b>SPLL</b>	<b>2.5.3</b> <b>GEN-Panel</b> Sync Out → AUDIO IN → GEN CLK → REF IN → SYNC PLL
<b>OUT</b> Put: <b>DIG</b> ital: <b>SYNC</b> : <b>TYPE</b>	<b>WCL</b> ock <b>BC</b> Lock	<b>2.5.3</b> <b>GEN-Panel</b> Type → WORD CLK → BIPHASE CLK
<b>OUT</b> Put: <b>DIG</b> ital: <b>UNB</b> alanced: <b>FEED</b>	<b>AOUT</b> put <b>AIN</b> put	<b>2.5.3</b> <b>GEN-Panel</b> Unbal Out → AUDIO OUT → AUDIO IN



Command	Parameter	Section
<b>OUTPut:IMPedance</b>	<b>R10</b> <b>R200</b> <b>R150</b> (Query response = R200) <b>R600</b>	<b>2.5.2</b> <b>GEN-Panel</b> Impedance → 10 Ω → 200 Ω → 150 Ω → 600 Ω
<b>OUTPut:SAMPlE:FREQuency</b>	<nu> , Opt. UPL-B2 (Digital Audio I/O): 27 kHz to 55 kHz (UPL-B2) Opt. UPL-B29 (Dig. Audio 96 kHz): 40 kHz to 106	<b>2.5.3</b> <b>GEN-Panel</b>
<b>OUTPut:SAMPlE[:FREQuency]:MODE</b>	<b>F32</b> <b>F44</b> <b>F48</b> <b>F88</b> <b>F96</b> <b>EXTern</b> <b>SYNChron</b> <b>VALue</b>	<b>2.5.3</b> <b>GEN-Panel</b> Sample Freq → 32 kHz → 44.1 kHz → 48 kHz → 88.2 kHz → 96 kHz → EXTERN → SYNCHRON → VALUE:
<b>OUTPut:SELEct</b>	<b>OFF</b> <b>CH1</b> <b>CH2</b> <b>CH2Is1</b>	<b>2.5.2</b> <b>2.5.3</b> <b>GEN-Panel</b> Channel(s) → OFF → 1 → 2 → 2 = 1
<b>OUTPut:SIGNal:BALEnced:LEVEl</b>	<nu>	<b>2.5.3</b> <b>GEN-Panel</b> Bal Vpp
<b>OUTPut:SIGNal:LEVEl</b>	<nu>	<b>2.5.3</b> <b>GEN-Panel</b> Unbal Vpp
<b>OUTPut:TYPE</b>	<b>BALEnced</b> <b>UNBALEnced</b>	<b>2.5.2</b> <b>GEN-Panel</b> Output → BAL → UNBAL
<b>OUTPut:VALidity</b>	<b>CH1And2</b> <b>NONE</b>	<b>2.5.3.2</b> <b>GEN-Panel</b> Validity
<b>OUTPut2:IMPedance</b>	<b>R10</b> <b>R200</b> <b>R600</b>	<b>2.5.5</b> <b>GEN-Panel</b> AUX GEN: Impedance → 10 Ω → 200 Ω → 600 Ω

Command	Parameter	Section
<b>OUTPut2:SElect</b>	OFF CH1 CH2 CH2Is1	<b>2.5.5</b> <b>GEN-Panel</b> AUX GEN: Channel(s) → OFF → 1 → 2 → 2 ≡ 1
<b>OUTPut2:TYPE</b>	UNBalanced BALanced	<b>2.5.5</b> <b>GEN-Panel</b> AUX GEN: Output → UNBAL → BAL
<b>SENSe:DIGital:FEED</b>	ADATa JPHase CINPut	<b>2.6.3.1</b> <b>ANLR-Panel</b> Meas Mode → AUDIO DATA → JITTER/PHAS → COMMON/INP
<b>SENSe:DIGital:SYNC:REFerence</b>	GClock PLLVari PLL32 PLL44 PLL48 PLL88 PLL96	<b>2.6.3</b> <b>ANLR-Panel</b> Related to → GEN CLK → VARI (PLL) → 32.0 (PLL) → 44.1 (PLL) → 48.0 (PLL) → 88,2 (PLL) → 96.0 (PLL)
<b>SENSe:DIGital:SYNC:SOURce</b>	AINPut RINPut	<b>2.6.3</b> <b>ANLR-Panel</b> Sync To → AUDIO IN → REF IN
<b>SENSe:EQUalize:CONTRol:POINts?</b>	<n> 0 to 1024 Query only	<b>2.9.1.3</b> <b>No manual operation</b>
<b>SENSe:EQUalize:CONTRol[:DATA]</b>	<n>{,<n>}	<b>2.9.1.3</b> <b>No manual operation</b>
<b>SENSe:FREQuency:FACTor</b>	<nu> MLT 1 to 20 for RMS-Sel. measurement	<b>2.6.5.3</b> <b>2.6.5.23</b> <b>ANLR-Panel</b> FREQ MODE → Factor
<b>SENSe:SWEEP:SYNC</b>	NORMAL BLOCK	<b>2.6.5.1</b> <b>2.6.5.23</b> <b>ANLR-Panel</b> Sweep Mode → NORMAL → BLOCK

Command	Parameter	Section
<b>SENSE:UFILter[1 to 9]:ORDer</b>	<b>N4</b> <b>N8</b>	<b>2.7.2</b> <b>FILTER-Panel</b> Order → 4 → 8
<b>SENSE:VOLTage:EQUalize:POINts?</b>	<n> 0 to 1024 Query only	<b>2.9.1.3</b> <b>No manual operation</b>
<b>SENSE:VOLTage:EQUalize[:DATA]</b>	<n>{,<n>}	<b>2.9.1.3</b> <b>No manual operation</b>
<b>SENSE:VOLTage:EQUalize[:STATe]</b>	<b>ON</b> <b>OFF</b>	<b>2.6.5.7</b> <b>2.6.5.12</b> <b>ANL Panel</b> Equalizer → ON → OFF
<b>SENSE:VOLTage:INTV:MODE</b>	<b>OFF</b> <b>FORever</b> <b>SMOoth</b> <b>EDGE</b>	<b>2.6.5.24</b> <b>ANLR-Panel</b> Max Hold → OFF → FOREVER → SLOW DECAY → FAST DECAY
<b>SENSE:VOLTage:INTV:MODE</b>	<b>OFF</b> <b>ON</b>	<b>2.6.5.25</b> <b>ANLR-Panel</b> Max Hold → OFF → ON
<b>SENSE[:POWER:REFerence:RESistance</b>	<nu> 1 mΩ to 100 kΩ	<b>2.4 (RREF)</b> <b>2.6.2</b> <b>ANLR-Panel</b> Ref Imped
<b>SENSE[:VOLTage:RANGe[1 2]:AUTO</b>	<b>ON</b> <b>OFF</b>	<b>2.6.22.6.2</b> <b>ANLR-Panel</b> Range → AUTO
<b>SENSE[:VOLTage:RANGe[1 2]:LOWer</b>	<nu> Value range see 2.6.2 Configuration of the Analog Analyzers	<b>2.6.2</b> <b>ANLR-Panel</b> Range → LOWER
<b>SENSE[:VOLTage:RANGe[1 2]:UPPer]</b>	<nu> Value range see 2.6.2 Configuration of the Analog Analyzers	<b>2.6.2</b> <b>ANLR-Panel</b> Range → FIX
<b>SENSE[1]:BWIDth[:RESolution]</b> gleichbedeutend mit <b>SENSE[1]:BANDwidth[:RESolution]</b>	<nu> Value range determined by instrument or function	<b>2.6.5.3</b> <b>ANLR-Panel</b> Bandwidth

Command	Parameter	Section
<b>SENSe[1]:BWIDth[:RESolution]:MODE</b> gleichbedeutend mit <b>SENSe[1]:BANDwidth[:RESolution]:MODE</b>	PPCT1 PPCT3 PTOCt POCT12 PFIx PFASt SPCT1 SPCT3 STOCt SOCT12 SFIx SFASt	<b>2.6.5.3</b> <b>ANLR-Panel</b> Bandwidth → BP 1% → BP 3 % → BP 1/3 OCT → BP 1/12 OCT → BP FIX: → BP FAST → BS 1% → BS 3 % → BS 1/3 OCT → BS 1/12 OCT → BS FIX: → BS FAST
<b>SENSe[1]:CHANnel:DELay</b>	<nu> -10 to 10 s	<b>2.6.5.12</b> <b>2.6.5.22</b> <b>ANLR-Panel</b> Chan Delay
<b>SENSe[1]:DATA1 2?</b>	<n> Query only	<b>3.15.8</b> <b>Result display</b>
<b>SENSe[1]:FILTer&lt;i&gt;</b>	<i>* = 1 to 3 OFF Query returns name of the filter switched on: UFIL1 : UFIL9 AWE CMES CCIT CCIR CCIU DEMP5015 DEMP50 DEMP75 DEMP17 WRUM URUM DCN CARM IECT JITT	<b>2.7.1</b> <b>FILTER-Panel</b> Filter
<b>SENSe[1]:FILTer&lt;i&gt;:AWEighting[:STATe]</b>	<i> 1 to 3 ON OFF	<b>2.7.1</b> <b>FILTER-Panel</b> Filter → A Weighting
<b>SENSe[1]:FILTer&lt;i&gt;:CARM[:STATe]</b>	<i> 1 to 3 ON OFF	<b>2.7.1</b> <b>FILTER-Panel</b> Filter → CCIR ARM
<b>SENSe[1]:FILTer&lt;i&gt;:CCIR[:STATe]</b>	<i> 1 to 3 ON OFF	<b>2.7.1</b> <b>FILTER-Panel</b> Filter → CCIR wtd

Command	Parameter	Section
<b>SENSe[1]:FILTer&lt;i&gt;:CCITt[:STATe]</b>	<i> 1 to 3 <b>ON OFF</b>	<b>2.7.1</b> <b>FILTER-Panel</b> Filter → CCITT
<b>SENSe[1]:FILTer&lt;i&gt;:CCIUnweight[:STATe]</b>	<i> 1 to 3 <b>ON OFF</b>	<b>2.7.1</b> <b>FILTER-Panel</b> Filter → CCIR unwtcd
<b>SENSe[1]:FILTer&lt;i&gt;:CMESsage[:STATe]</b>	<i> 1 to 3 <b>ON OFF</b>	<b>2.7.1</b> <b>FILTER-Panel</b> Filter → C MESSAGE
<b>SENSe[1]:FILTer&lt;i&gt;:DCNoise[:STATe]</b>	<i> 1 to 3 <b>ON OFF</b>	<b>2.7.1</b> <b>FILTER-Panel</b> Filter → DC NOISE HP
<b>SENSe[1]:FILTer&lt;i&gt;:DEMPhasis17[:STATe]</b>	<i> 1 to 3 <b>ON OFF</b>	<b>2.7.1</b> <b>FILTER-Panel</b> Filter → DEEMPH J.17
<b>SENSe[1]:FILTer&lt;i&gt;:DEMPhasis50[:STATe]</b>	<i> 1 to 3 <b>ON OFF</b>	<b>2.7.1</b> <b>FILTER-Panel</b> Filter → DEEMPH 50
<b>SENSe[1]:FILTer&lt;i&gt;:DEMPhasis5015[:STATe]</b>	<i> 1 to 3 <b>ON OFF</b>	<b>2.7.1</b> <b>FILTER-Panel</b> Filter → DEEM 50/15
<b>SENSe[1]:FILTer&lt;i&gt;:DEMPhasis75[:STATe]</b>	<i> 1 to 3 <b>ON OFF</b>	<b>2.7.1</b> <b>FILTER-Panel</b> Filter → DEEMPH 75
<b>SENSe[1]:FILTer&lt;i&gt;:IECTuner[:STATe]</b>	<i> 1 to 3 <b>ON OFF</b>	<b>2.7.1</b> <b>FILTER-Panel</b> Filter → IEC Tuner
<b>SENSe[1]:FILTer&lt;i&gt;:JITTer[:STATe]</b>	<i> 1 to 4 <b>ON   OFF</b>	<b>2.7.1</b> <b>FILTER-Panel</b> Filter → JITTER wtd
<b>SENSe[1]:FILTer&lt;i&gt;:UFILter1...:UFILter9[:STATe]</b>	<i> 1 to 3 <b>ON OFF</b>	<b>2.7.1</b> <b>FILTER-Panel</b> Filter
<b>SENSe[1]:FILTer&lt;i&gt;:URUMble[:STATe]</b>	<i> 1 to 3 <b>ON OFF</b>	<b>2.7.1</b> <b>FILTER-Panel</b> Filter → RUMBLE unw

Command	Parameter	Section
<b>SENSe[1]:FILTEr&lt;i&gt;:WRUMble[:STATe]</b>	<i> 1 to 3 <b>ON OFF</b>	<b>2.7.1</b> <b>FILTEr-Panel</b> Filter → RUMBLE wtd
<b>SENSe[1]:FILTEr2:.....</b>		<b>2.7.1</b> <b>ANLR panel</b> Filter
<b>SENSe[1]:FREQuency:APERture:MODE</b>	<b>FAST</b> <b>PRECision</b>	<b>2.6.5.19</b> <b>ANLR-Panel</b> Meas Time → FAST → PRECISION
<b>SENSe[1]:FREQuency:LIMit:LOWer</b>	<nu> Value range determined by instrument or function	<b>2.6.5.7</b> <b>2.6.5.23</b> <b>2.6.5.24</b> <b>2.6.5.25</b> <b>ANLR-Panel</b> → Frq Lim Low
<b>SENSe[1]:FREQuency:LIMit:UPPer</b>	<nu> Value range determined by instrument or function	<b>2.6.5.7</b> <b>2.6.5.23</b> <b>2.6.5.24</b> <b>2.6.5.25</b> <b>ANLR-Panel</b> → Frq Lim Upp
<b>SENSe[1]:FREQuency:MODE</b>	<b>FIXed CW</b> <b>SWEep</b> <b>LIST</b> <b>MULTisine</b>  <b>GENTrack</b> <b>CH1</b> <b>CH2</b>	<b>2.6.5.3</b> <b>ANLR panel</b> SWEEP CTRL → OFF → AUTO SWEEP MANU SWEEP → AUTO LIST MANU LIST → GEN MLTSINE  FREQ MODE → GEN TRACK → FREQ CH1 → FREQ CH2
<b>SENSe[1]:FREQuency:STARt</b> <b>SENSe[1]:FREQuency:STOP</b>	<nu> Value range determined by instrument or function	<b>2.6.5.3</b> <b>ANLR-Panel</b> SWEEP CTRL → Start   Stop
<b>SENSe[1]:FREQuency[:FIXed CW]</b>	<nu> Value range determined by instrument or function	<b>2.6.5.3</b> <b>ANLR-Panel</b> FREQ MODE → FIX

Command	Parameter	Section
<b>SENSE[1]:FUNCTION</b>	'OFF' 'RMS' 'RMSselectiv' 'PEAK' 'QREak' 'DC' 'THD' 'THDNs ndr' 'MDISt' 'DFD' 'WAF' 'POLarity' 'FFT' 'FILTersimulation' 'WAVeform' 'COHerence' 'RUBBbuzz' 'PROTocol' 'THIRdoct'	<b>2.6.5</b> <b>ANLR-Panel</b> FUNCTION → OFF → RMS & S/N → RMS SELECT → PEAK & S/N → QPK & S/N → DC → THD → THD+N/SINAD → MOD DIST → DFD → WOW & FL → POLARITY → FFT → FILTER SIM. → WAVEFORM → COHERENCE → RUB & BUZZ → PROTOCOL → THIRD OCT
<b>SENSE[1]:FUNCTION</b>	'OFF' 'RMS' 'RMSselectiv' 'PEAK' 'QPEak' 'DC' 'THD' 'THDNs ndr' 'MDISt' 'DFD' 'WAF' 'POLarity' 'FFT' 'FILTersim' 'WAVeform' 'PROTocol' 'TWELvthoct'	<b>2.6.5</b> <b>ANLR-Panel</b> FUNCTION → OFF → RMS & S/N → RMS SELECT → PEAK & S/N → QPK & S/N → DC → THD → THD+N/SINAD → MOD DIST → DFD → WOW & FL → POLARITY → FFT → FILTER SIM. → WAVEFORM → PROTOCOL → 12th OCTAVE
<b>SENSE[1]:FUNCTION:DCSuppression</b>	ON OFF	<b>2.6.5.1</b> ANLR-Panel DC Suppres → ON → OFF
<b>SENSE[1]:FUNCTION:DISTortion</b>	<n>	<b>2.6.5.6</b> <b>ANLR-Panel</b> → di2468
<b>SENSE[1]:FUNCTION:DMODE</b>	FAST PRECision	<b>2.6.5.6</b> <b>2.6.5.7</b> <b>2.6.5.8</b> <b>2.6.5.9</b> <b>ANLR-Panel</b> Dyn Mode → FAST → PRECISION

Command	Parameter	Section
<b>SENSE[1]:FUNCTION:MCOunt</b>	<b>T30</b> <b>T32</b>	<b>2.6.5.24</b> <b>ANLR-Panel</b> Line Count → 30 → 32
<b>SENSE[1]:FUNCTION:MMODE</b>	<b>PPEak</b> <b>NPEak</b> <b>PTOPeak</b> <b>PABSolut</b>  <b>SELectdi</b> <b>LSELectdi</b> <b>DALL</b> <b>LDALI</b> <b>DODD</b> <b>LDODd</b> <b>DEVen</b> <b>LDEVen</b>  <b>THDN</b> <b>LTHDn</b> <b>SNDRatio</b> <b>NOISe</b> <b>LNOise</b>  <b>D2_268</b> alias <b>D2</b> <b>D3_268</b> alias <b>D3</b> <b>D2_118</b> <b>D3_118</b>  <b>STANdard</b> <b>COMPressed</b> <b>USAMpl</b>  <b>O33</b>	<b>2.6.5.4</b> <b>ANLR-Panel</b> Meas Mode → PK + → PK - → PK to PK → PK abs <b>2.6.5.6</b> → SELECT di → LEV SEL di → All di → LEV All di → All odd di → LEV odd di → All even di → LEV even di <b>2.6.5.7</b> → THD+N → LEVEL THD+N → SINAD → NOISE → LEVEL NOISE <b>2.6.5.9</b> → d2 (IEC268) → d3 (IEC268) → d2 (IEC118) → d3 (IEC118) <b>2.6.5.14</b> → STANDARD → COMPRESSED → UNDERSAMP
<b>SENSE[1]:FUNCTION:SETTling:...</b>		<b>2.3.4.2</b> <b>ANLR-Panel</b> Fnct Settling
<b>SENSE[1]:FUNCTION:SETTling:COUNT</b>	<b>&lt;n&gt;</b> EXP   FLAT: 2 to 6 AVER: 2 to 100	<b>2.6.5.1</b> <b>ANLR-Panel</b> Samples
<b>SENSE[1]:FUNCTION:SETTling:MODE</b>	<b>OFF</b> <b>EXPonential</b> <b>FLAT</b> <b>AVERAge</b>	<b>2.6.5.1</b> <b>ANLR-Panel</b> Settling → OFF → EXPonential → FLAT → AVERAge
<b>SENSE[1]:FUNCTION:SETTling:RESolution</b>	<b>&lt;nu&gt;</b> Value range and units are determined by instrument or function see 2.6.5.1	<b>2.6.5.1</b> <b>ANLR-Panel</b> Resolution



Command	Parameter	Section
<b>SENSE[1]:FUNCTION:SETTLing:TOLerance</b>	<n> 0.001 to 10 %	<b>2.6.5.1</b> <b>ANLR-Panel</b> Tolerance
<b>SENSE[1]:FUNCTION:SETTLing:TOUT</b>	<nu> 0.001 to 10 s	<b>2.6.5.1</b> <b>ANLR-Panel</b> Timeout
<b>SENSE[1]:FUNCTION:SNSequence</b>	<b>ON</b> <b>OFF</b>	<b>2.6.5.1</b> <b>ANLR-Panel</b> S/N Sequ → ON → OFF
<b>SENSE[1]:FUNCTION:STANdard</b>	<b>NAB</b> <b>JIS</b> <b>DINiec</b> <b>SI05</b> <b>SI10</b>	<b>2.6.5.10</b> <b>ANLR-Panel</b> Rule → NAB → JIS → DIN/IEC → 2 Sigma 5 s → 2 Sigma 10s
<b>SENSE[1]:FUNCTION:WEIGHting</b>	<b>ON</b> <b>OFF</b>	<b>2.6.5.10</b> <b>ANLR-Panel</b> Weighting → ON → OFF
<b>SENSE[1]:LIST:FREQUency</b>	<n>{,<n>}	<b>2.9.1.3</b> <b>No manual</b> <b>control</b>
<b>SENSE[1]:LIST:FREQUency:POINts?</b>	<n> 0 to 1023 Query only	<b>2.9.1.3</b> <b>No manual</b> <b>control</b>
<b>SENSE[1]:LIST:MODE</b>	<b>AUTO</b> <b>MANual</b>	<b>2.6.5.3</b> <b>ANLR-Panel</b> SWEEP CTRL → AUTO LIST → MANU LIST
<b>SENSE[1]:NOTCh:FREQUency:FIXed</b>	<nu> Value range determined by instrument or function	<b>2.6.5.1</b> <b>ANLR-Panel</b> Notch Freq → VALUE:
<b>SENSE[1]:NOTCh:FREQUency:MODE</b>	<b>FIXed</b> <b>GENTrack</b>	<b>2.6.5.1</b> <b>ANLR-Panel</b> Notch Freq → VALUE: → GEN TRACK
<b>SENSE[1]:NOTCh[:STATe]</b>	<b>DB0</b> <b>DB12</b> <b>DB30</b> <b>OFF</b>	<b>2.6.5.1</b> <b>ANLR-Panel</b> Anlg. Notch → 0 dB → 12 dB → 30 dB → OFF

Command	Parameter	Section
<b>SENSe[1]:O33?</b>	Query only Query response: ASCII string.	<b>No manual control</b>
<b>SENSe[1]:SMOothing:APERture</b>	<b>N1</b> <b>N2</b> <b>N4</b> <b>N8</b> <b>N16</b> <b>N32</b>	<b>2.6.5.14</b> <b>ANLR-Panel</b> Interpol → 1 → 2 → 4 → 8 → 16 → 32
<b>SENSe[1]:SWEep:MODE</b>	<b>AUTO</b> <b>MANual</b>	<b>2.6.5.3</b> <b>ANLR-Panel</b> SWEEP CTRL → AUTO SWEEP → MANU SWEEP
<b>SENSe[1]:SWEep:POINts</b>	<b>&lt;n&gt;</b> 2 to 1024	<b>2.6.5.3</b> <b>ANLR-Panel</b> Points
<b>SENSe[1]:SWEep:SPACing</b>	<b>LINear</b> <b>LOGarithmic</b>	<b>2.6.5.3</b> <b>ANLR-Panel</b> Spacing → LIN → LOG
<b>SENSe[1]:SWEep:STEP</b>	<b>&lt;nu&gt;   &lt;n&gt;</b>	<b>2.6.5.3</b> <b>ANLR-Panel</b> Steps
<b>SENSe[1]:THDN:REJection</b>	<b>NARRow</b> <b>WIDE</b>	<b>2.6.5.7</b> <b>ANLR-Panel</b> Rejection → NARROW → WIDE
<b>SENSe[1]:TRIGger:SETTling:.....</b>		<b>2.3.4.2</b> <b>ANLR-Panel</b> Fnct Sett
<b>SENSe[1]:TRIGger:SETTling:COUNt</b>	<b>&lt;n&gt;</b> EXP   FLAT: 2 to 6 AVER: 2 to 100	<b>2.6.5.1</b> <b>ANLR-Panel</b> Samples
<b>SENSe[1]:TRIGger:SETTling:MODE</b>	<b>OFF</b> <b>EXP</b> onential <b>FLAT</b> <b>AVER</b> age	<b>2.6.5.1</b> <b>ANLR-Panel</b> Settling → OFF → EXPONENTIAL → FLAT → AVERAGE
<b>SENSe[1]:TRIGger:SETTling:RESolution</b>	<b>&lt;nu&gt;</b> Value range and units determined by instrument or function see 2.6.5.1	<b>2.6.5.1</b> <b>ANLR-Panel</b> Resolution

Command	Parameter	Section
<b>SENSe[1]:TRIGger:SETTling:TOLerance</b>	<n> 0.001 to 10 %	<b>2.6.5.1</b> <b>ANLR-Panel</b> Tolerance
<b>SENSe[1]:UFILter&lt;i&gt;:ATTenuation</b>	<i> 1 to 9 <nu> 3 to 120 dB	<b>2.7.2.1</b> <b>FILTER-Panel</b> FILTER 1 to 9 → Atten
<b>SENSe[1]:UFILter&lt;i&gt;:BPASs[:STATe]</b>	<i> 1 to 9 <b>ON</b>	<b>2.7.2</b> <b>FILTER-Panel</b> FILTER 01 to 09
<b>SENSe[1]:UFILter&lt;i&gt;:BSTOp[:STATe]</b>	<i> 1 to 9 <b>ON</b>	<b>2.7.2</b> <b>FILTER-Panel</b> FILTER 01 to 09
<b>SENSe[1]:UFILter&lt;i&gt;:CENTer</b>	<i> 1 to 9 <nu> Value range see 2.6.1 Selecting the Analyzer	<b>2.7.2.4</b> <b>2.7.2.5</b> <b>FILTER-Panel</b> FILTER 1 to 9 → Center Frq
<b>SENSe[1]:UFILter&lt;i&gt;:DELAy</b>	<i> 1 to 9 <nu> 0 to 1 s Query only for all filters except for file-defined filters	<b>2.7.2.7</b> <b>2.7.2.1</b> Query only <b>FILTER-Panel</b> FILTER 1 to 9 → Delay
<b>SENSe[1]:UFILter&lt;i&gt;:FILE</b>	'filename' <i> 1 to 9	<b>2.7.2.7</b> <b>FILTER-Panel</b> FILTER 1 to 9 → Filename
<b>SENSe[1]:UFILter&lt;i&gt;:FILE[:STATe]</b>	<i> 1 to 9 <b>ON</b>	<b>2.7.2</b> <b>FILTER-Panel</b> FILTER 01 to 09
<b>SENSe[1]:UFILter&lt;i&gt;:HPASs[:STATe]</b>	<i> 1 to 9 <b>ON</b>	<b>2.7.2</b> <b>FILTER-Panel</b> FILTER 01 to 09
<b>SENSe[1]:UFILter&lt;i&gt;:LPASs[:STATe]</b>	<i> 1 to 9 <b>ON</b>	<b>2.7.2</b> <b>FILTER-Panel</b> FILTER 01 to 09
<b>SENSe[1]:UFILter&lt;i&gt;:NOTCh[:STATe]</b>	<i> 1 to 9 <b>ON</b>	<b>2.7.2</b> <b>FILTER-Panel</b> FILTER 01 to 09
<b>SENSe[1]:UFILter&lt;i&gt;:OCTav[:STATe]</b>	<i> 1 to 9 <b>ON</b>	<b>2.7.2</b> <b>FILTER-Panel</b> FILTER 01 to 09
<b>SENSe[1]:UFILter&lt;i&gt;:PASSb</b>	<i> 1 to 9 <nu> Value range see <b>2.6.1</b>	<b>2.7.2.2</b> <b>FILTER-Panel</b> FILTER 1 to 9 → Passband

Command	Parameter	Section
<b>SENSE[1]:UFILTER&lt;i&gt;:PASSb:LOWer</b>	<i> 1 to 9 <nu> Value range see 2.6.1	<b>2.7.2.3</b> <b>FILTER-Panel</b> FILTER 1 to 9 → Passb low
<b>SENSE[1]:UFILTER&lt;i&gt;:PASSb:UPPer</b>	<i> 1 to 9 <nu> Value range see 2.6.1	<b>2.7.2.3</b> <b>FILTER-Panel</b> FILTER 1 to 9 → Passb upp
<b>SENSE[1]:UFILTER&lt;i&gt;:STOPb:LOWer?</b>	<i> 1 to 9 <nu> Query only	<b>2.7.2.3</b> <b>FILTER-Panel</b> FILTER 1 to 9 → Stopb low
<b>SENSE[1]:UFILTER&lt;i&gt;:STOPb:UPPer?</b>	<i> 1 to 9 <nu> Query only	<b>2.7.2.3</b> <b>FILTER-Panel</b> FILTER 1 to 9 → Stopb upp
<b>SENSE[1]:UFILTER&lt;i&gt;:STOPb?</b>	<i> 1 to 9 <nu> Query only	<b>2.7.2.2</b> <b>FILTER-Panel</b> FILTER 1 to 9 → Stopband
<b>SENSE[1]:UFILTER&lt;i&gt;:TOCTave[:STATe]</b>	<i> 1 to 9 <b>ON</b>	<b>2.7.2</b> <b>FILTER-Panel</b> FILTER 01 to 09
<b>SENSE[1]:UFILTER&lt;i&gt;:WIDTH</b>	<i> 1 to 9 <nu> Value range see 2.6.1	<b>2.7.2.4</b> <b>2.7.2.5</b> <b>FILTER-Panel</b> FILTER 1 to 9 → Width
<b>SENSE[1]:UNIT</b>	<b>PCT DB</b>	<b>2.4</b> <b>ANLR-Panel</b> Unit
<b>SENSE[1]:VOLTage:APERture</b>	<nu> = >1 ms ... Value range see 2.6.5.2	<b>2.6.5.2</b> <b>2.6.5.3</b> <b>2.6.5.24</b> <b>2.6.5.25</b> <b>ANLR-Panel</b> Meas Time
<b>SENSE[1]:VOLTage:APERture:MODE</b>	<b>AFASt</b> <b>AUTO</b> <b>TRIGgered</b> <b>GENTrack</b> <b>VALue</b> <b>FAST</b>	<b>2.6.5.2,</b> <b>2.6.5.3</b> <b>2.6.5.5</b> <b>2.6.5.24</b> <b>ANLR-Panel</b> Meas Time → AUTO FAST → AUTO → TRIGGERED → GEN TRACK → VALUE → FIX 200ms

Command	Parameter	Section
<b>SENSe[1]:VOLTage:APERture:MODE</b>	VALue	<b>2.6.5.25</b> <b>ANLR-Panel</b> Meas Time → VALUE:
<b>SENSe[1]:VOLTage:FUNDamental</b>	<nu> Value range and units determined by instrument or function	<b>2.6.5.6</b> <b>ANLR-Panel</b> Fundamentl
<b>SENSe[1]:VOLTage:FUNDamental:MODE</b>	<b>AUTO</b> VALue	<b>2.6.5.6</b> <b>2.6.5.7</b> <b>ANLR-Panel</b> Fundamentl → AUTO → VALUE:
<b>SENSe[1]:VOLTage:INTVtime</b>	<nu> 20 ms to 10 s 20 ms to 100 s	<b>2.6.5.4</b> <b>2.6.5.24</b> <b>ANLR-Panel</b> Intv Time
<b>SENSe[1]:VOLTage:INTVtime:MODE</b>	<b>SFAST</b> <b>FAST</b> <b>SLOW</b> <b>FIXed</b> VALue	<b>2.6.5.4</b> <b>ANLR-Panel</b> Intv Time → FIX 50ms → FIX 200ms → FIX 1000ms → FIX 3 SEC → VALUE:
<b>SENSe[1]:WAVEform:COMPression</b>	<n> 2 to 1024	<b>2.6.5.14</b> <b>ANLR-Panel</b> Comp Fact
<b>SENSe[1]:WAVEform:DURation</b>	<nu> see 2.6.5.14 WAVEFORM	<b>2.6.5.14</b> <b>ANLR-Panel</b> Trace Len
<b>SENSe[1][:VOLTage POWER]:REFerence</b>	<nu> Analog instruments 100 pV to 1000 V Digital instrument 0.0 to 1.0 FS   100 pFS to 100 FS	<b>2.6.5.1</b> <b>ANLR-Panel</b> Reference   Ref Volt
<b>SENSe[1][:VOLTage POWER]:REFerence:MODE</b>	<b>CH1Store</b> <b>CH2Store</b> <b>CH1Meas</b> <b>CH2Meas</b> <b>STORE</b> <b>GENTrack</b> VALue	<b>2.6.5.1</b> <b>ANLR-Panel</b> Reference → STORE CH1 → STORE CH2 → MEAS CH1 → MEAS CH2 → STORE → GEN TRACK → VALUE:
<b>SENSe[1][:VOLTage POWER]:UNIT[1 2]</b>	<b>PCT</b> <b>DB</b> see 3.10.4 Units for IEC Measurement Results	<b>2.4</b> <b>ANLR-Panel</b> Unit Ch1/Ch2

Command	Parameter	Section
<b>SENSe[1][:VOLTage POWer]:UNIT[1 2]</b>	Analog units: V   DBV   DBU   DBM   W   DPCTV   DV   VVR   PCTVVR   DPCTW  DW   PPR   PCTPPR  DBR  Digital units: FS   PCTFS   DBFS   DPCT   DBR   LSBS   BITS	<b>2.4</b> <b>ANLR-Panel</b> Unit Ch1/Ch2
<b>SENSe2:DATA1 2?</b>	<nu> Query only	<b>3.15.8</b> <b>Result display</b>
<b>SENSe2:FUNCTion</b>	'OFF' 'PEAKvoltage' 'RMS' 'PHASetoref' 'DIGInpampl'	<b>2.6.5.18</b> <b>ANLR-Panel</b> INPUT DISP → OFF → PEAK → RMS → PHAS to REF → DIG INP AMP
<b>SENSe2:VOLTage:REFerence</b>	<nu> Analog instruments 1 mV to 1000 V Digital instrument 0.0 to 1.0 FS	<b>2.6.5.1</b> <b>ANLR-Panel</b> Reference
<b>SENSe2:VOLTage:REFerence:MODE</b>	CH1Store CH2Store STORE CH1Meas CH2Meas GENTrack DIGoutampl VALue	<b>2.6.5.1</b> <b>ANLR-Panel</b> Reference → STORE CH1 → STORE CH2 → MEAS CH1 → MEAS CH2 → STORE → GEN TRACK → DIG OUT AMP → VALUE:
<b>SENSe3:DATA1 2?</b>	Query only	<b>3.15.8</b> <b>Result display</b>
<b>SENSe3:FREQUency:REFerence</b>	<nu> -1 MHz to 1 MHz	<b>2.6.5.1</b> <b>ANLR-Panel</b> Ref Freq
<b>SENSe3:FREQUency:REFerence:MODE</b>	CH1Store CH2Store CH1Meas CH2Meas STORE GENTrack VALue	<b>2.6.5.1</b> <b>ANLR-Panel</b> Reference → STORE CH1 → STORE CH2 → MEAS CH1 → MEAS CH2 → STORE → GEN TRACK → VALUE:

Command	Parameter	Section
<b>SENSe3:FREQuency:REFerence:MODE</b>	CH1Store CH2Store STORe CH1Meas CH2Meas GENTrack VALue	2.6.5.19 <b>ANLR-Panel</b> Ref Freq → STORE CH1 → STORE Ch2 → STORE → MEAS CH1 → MEAS CH2 → GEN TRACK → VALUE:
<b>SENSe3:FREQuency:SETTling:.....</b>		2.3.4.2 <b>ANLR-Panel</b> Freq Settl
<b>SENSe3:FREQuency:SETTling:COUNT</b>	<n> EXP   FLAT: 2 to 6 AVER: 2 to 100	2.6.5.1 <b>ANLR-Panel</b> Samples
<b>SENSe3:FREQuency:SETTling:MODE</b>	OFF EXPonential FLAT AVERage	2.6.5.1 <b>ANLR-Panel</b> Settling → OFF → EXPonential → FLAT → AVERage
<b>SENSe3:FREQuency:SETTling:RESolution</b>	<nu> Value range and units determined by instrument or function see 2.6.5.1	2.6.5.1 <b>ANLR-Panel</b> Resolution
<b>SENSe3:FREQuency:SETTling:TOLerance</b>	<nu> 0.001 to 10 %	2.6.5.1 <b>ANLR-Panel</b> Tolerance
<b>SENSe3:FREQuency:SETTling:TOUT</b>	<nu> 0.001 to 10 s	2.6.5.1 <b>ANLR-Panel</b> Timeout
<b>SENSe3:FREQuency:UNIT[1 2]</b>	HZ DHZ DPCTHZ TERZ OCT DEC FFR	2.4 <b>ANLR-Panel</b> Unit Ch1/Ch2
<b>SENSe3:FUNCTION</b>	'OFF' 'FREQuency' 'SFREQuency' 'FQPHase' 'FQGRoupdelay'	2.6.5.19 2.6.5.20 2.6.5.21 <b>ANLR-Panel</b> FREQ/PHAS → OFF → FREQ → SAMPLE FREQ → FREQ&PHASE → FREQ&GRPDEL

Command	Parameter	Section
<b>SENSe3:PHASe:FORMat</b>	POSitive POSNegative NEGative RAD RADBipolar RADNegative	<b>2.6.5.19</b> <b>ANLR-Panel</b> Format Pha → 0 to 360° → -180° to 180° → -360° to 0° → 0 to 2 $\pi$ → - $\pi$ to + $\pi$ → -2 $\pi$ to 0
<b>SENSe3:PHASe:REFerence</b>	<nu> -360° to +360°	<b>2.6.5.1</b> <b>ANLR-Panel</b> Reference
<b>SENSe3:PHASe:REFerence:MODE</b>	STORe VALue	<b>2.6.5.1</b> <b>ANLR-Panel</b> Reference → STORE → VALUE:
<b>SENSe3:PHASe:SETTling:.....</b>		<b>2.3.4.2</b> <b>ANLR-Panel</b> Phas Settl
<b>SENSe3:PHASe:SETTling:COUNT</b>	<n> EXP   FLAT: 2 to 6 AVER: 2 to 100	<b>2.6.5.1</b> <b>ANLR-Panel</b> Samples
<b>SENSe3:PHASe:SETTling:MODE</b>	OFF EXPonential FLAT AVERage	<b>2.6.5.1</b> <b>ANLR-Panel</b> Settling → OFF → EXPonential → FLAT → AVERage
<b>SENSe3:PHASe:SETTling:RESolution</b>	<nu> Value range and units determined by instrument or function see <b>2.6.5.1</b>	<b>2.6.5.1</b> <b>ANLR-Panel</b> Resolution
<b>SENSe3:PHASe:SETTling:TOUT</b>	<nu> 0.001 to 10 s	<b>2.6.5.1</b> <b>ANLR-Panel</b> Timeout
<b>SENSe3:PHASe:UNIT2</b>	DEG RAD DDEG DRAD S DS	<b>2.4</b> <b>ANLR-Panel</b> Unit Ch2
<b>SENSe4:DATA?</b>	<nu> Query only	<b>3.15.8</b> <b>Result display</b>



Command	Parameter	Section
<b>SOURce:AM:MODE</b>	<b>OFF</b> <b>SINusoid</b> <b>BURSt</b>	<b>2.5.4.4</b> <b>GEN-Panel</b> Ampl Var → OFF → SINE → BURST
<b>SOURce:AM:MODE</b>	<b>OFF</b> <b>SINusoid</b> <b>BURSt</b>	<b>2.5.4.9</b> <b>2.5.4.10</b> <b>GEN-Panel</b> Ampl Var → OFF → SINE → BURST
<b>SOURce:CODedaudio:CHANnel</b>	<b>CH2</b> <b>CH6</b> <b>CHL</b> <b>CHC</b> <b>CHR</b> <b>CHLS</b> <b>CHRS</b> <b>CHLF</b>	<b>2.5.4.16</b> <b>GEN Panel</b> Chan Mode → 2/0 192kb/s → 5.1 448kb/s → L 448kb/s → C 448kb/s → R 448kb/s → LS 448kb/s → RS 448kb/s → LFE 448kb/s
<b>SOURce:CODedaudio:FORMat</b>	<b>AC3</b>	<b>2.5.4.16</b> <b>GEN Panel</b> Format → AC-3
<b>SOURce:CODedaudio:FREQUency</b>	<b>F042</b> <b>F997</b> <b>F15K</b>	<b>2.5.4.16</b> <b>GEN Panel</b> Frequency → 42 Hz → 997 Hz → 15 kHz
<b>SOURce:DIGital:FEED</b>	<b>ADATa</b> <b>JITTer</b> <b>PHASe</b> <b>COMMOn</b>	<b>2.5.3</b> <b>GEN-Panel</b> Src Mode → AUDIO DATA → JITTER ONLY → PHASE → COMMON ONLY
<b>SOURce:DIGital:REFerence</b>	<b>AZERo</b> <b>AONE</b>	<b>2.5.3</b> <b>GEN-Panel</b> Data → ALL ZERO → ALL ONE
<b>SOURce:DIGital:SYNC:DELay</b>	<b>&lt;nu&gt;</b>	<b>2.5.3.1</b> <b>GEN-Panel</b> PhaseToRef

Command	Parameter	Section
<b>SOURce:DIGital:SYNC:MODE</b>	V50 V60 WCLock IWCLock F1024	2.5.3 GEN-Panel Sync Mode → VIDEO 50 → VIDEO 60 → WORD CLK → WRD CLK INV → 1024 kHz
<b>SOURce:DIGital:SYNC:SOURce</b>	GCLock AINPut RINPut SINPut	2.5.3 GEN-Panel Sync Out → GEN CLK → AUDIO IN → REF IN → SYNC IN
<b>SOURce:EQUalize:CONTrol:POINTs?</b>	<n> 0 to 1023 Query only	2.9.1.3 No manual control
<b>SOURce:EQUalize:CONTrol[:DATA]</b>	<n>{,<n>}	2.9.1.3 No manual control
<b>SOURce:FREQUency</b>	<new>  5.21 Hz to 20 kHz at a sampling rate of 48 kHz	2.5.4.16 GEN Panel FREQUENCY
<b>SOURce:FREQUency:AM</b>	<nu> 1 $\mu$ Hz to $f_{max}$  $f_{max}$ depending on generator	2.5.4.4 2.5.4.9 2.5.4.10 GEN-Panel Mod Freq
<b>SOURce:FREQUency:CH2Stereo</b>	<nu> Value range determined by sample frequency	2.5.4.13 GEN-Panel Freq Ch2
<b>SOURce:FREQUency:DIFFerence</b>	<nu> Value range and units determined by instrument or function	2.5.4.8 GEN-Panel DIFF FREQ
<b>SOURce:FREQUency:MEAN</b>	<nu> Value range and units determined by instrument or function	2.5.4.8 GEN-Panel MEAN FREQ
<b>SOURce:FREQUency:MODE</b>	CW   FIXed SWEep1 SWEep2 LIST1 LIST2	2.5.4.2 GEN-Panel SWEEP CTRL X Axis Z Axis
<b>SOURce:FREQUency:MODE</b>	FIX	2.5.4.16 GEN Panel Vari Mode → FREQUENCY

Command	Parameter	Section
<b>SOURce:FREQuency:OFFSet:STATe</b>	<b>ON</b> <b>OFF</b>	<b>2.5.4.1</b> <b>GEN-Panel</b> Frq. Offset → + 1000 PPM → OFF
<b>SOURce:FREQuency:REFerence</b>	<b>&lt;nu&gt;</b> 1 mHz to 1 MHz	<b>2.5.2</b> <b>GEN-Panel</b> Ref.Freq
<b>SOURce:FREQuency:SELEct</b>	<b>FQPH</b> <b>FQFQ</b>	<b>2.5.4.13</b> <b>GEN-Panel</b> Freq Mode FREQ&PHASE FREQ CH1&2
<b>SOURce:FREQuency:STARt</b> <b>SOURce:FREQuency:STOP</b>	<b>&lt;nu&gt;</b> Value range and units determined by instrument or function	<b>2.5.4.2</b> <b>GEN-Panel</b> FREQUENCY → Start → Stop
<b>SOURce:FREQuency[:CW FIXed]</b>	<b>&lt;nu&gt;</b> Value range and units determined by instrument or function	<b>2.5.4.5</b> <b>GEN-Panel</b> FREQUENCY
<b>SOURce:FREQuency[&lt;i&gt;][:CW FIXed]</b>	<b>&lt;i&gt;</b> 1 to 17 <b>&lt;nu&gt;</b> Value range and units determined by instrument or function	<b>2.5.4.4</b> <b>GEN-Panel</b> Freq No1 to 17
<b>SOURce:FREQuency[1][:CW FIXed]</b>	<b>&lt;nu&gt;</b> Value range and units determined by instrument or function	<b>2.5.4.8</b> <b>GEN-Panel</b> UPPER FREQ
<b>SOURce:FREQuency[1][:CW FIXed]</b>	<b>&lt;nu&gt;</b> ANALOG-Gen: 240 Hz to 21,75 kHz DIGITAL-Gen: 240 Hz to $f_{max}$ $f_{max}$ see 2.5.1	<b>2.5.4.7</b> <b>GEN-Panel</b> UPPER FREQ
<b>SOURce:FREQuency2[:CW FIXed]</b>	<b>&lt;nu&gt;</b> 0 Hz to $f_{max} / 8$  $f_{max}$ see 2.5.1	<b>2.5.4.7</b> <b>2.5.4.14</b> <b>GEN-Panel</b> LOWER FREQ Carr Freq

Command	Parameter	Section
<b>SOURCE:FUNCTION:MODE</b>	<b>EQUAL</b> voltage <b>DEFINEd</b> voltage  <b>IEC268</b> <b>IEC118</b>  <b>FM</b> <b>AM</b>	<b>2.5.4.4</b> <b>GEN-Panel</b> Mode → EQUAL VOLT → DEFINE VOLT <b>2.5.4.1.1</b> <b>GEN-Panel</b> Mode → IEC 268 → IEC 118  <b>2.5.4.14</b> <b>GEN-Panel</b> Mode → FM → AM
<b>SOURCE:FUNCTION[:SHAPE]</b>	<b>SIN</b> usoid <b>MULT</b> isine <b>BURSt</b> <b>S2P</b> ulse <b>MDISt</b> <b>DFD</b> <b>RANd</b> om <b>USER</b> <b>POL</b> arity	<b>2.5.4</b> <b>GEN-Panel</b> FUNCTION → SINE → MULTISINE → SINE BURST → SINE <sup>2</sup> BURST → MOD DIST → DFD → RANDOM → ARBITRARY → POLARITY
<b>SOURCE:FUNCTION[:SHAPE]</b>	<b>SIN</b> usoid <b>STER</b> eo <b>MULT</b> isine <b>BURSt</b> <b>S2P</b> ulse <b>MDISt</b> <b>DFD</b> <b>RANd</b> om <b>USER</b> <b>POL</b> arity <b>FSK</b> <b>FM</b> <b>DC</b> <b>CODe</b> daud	<b>2.5.4</b> <b>GEN-Panel</b> FUNCTION → SINE → STEREO SINE → MULTISINE → SINE BURST → SINE <sup>2</sup> BURST → MOD DIST → DFD → RANDOM → ARBITRARY → POLARITY → FSK → MODULATION → DC → CODED AUDIO
<b>SOURCE:INTERval</b>	<nu> set burst duration ... 60 s	<b>2.5.4.4</b> <b>2.5.4.9</b> <b>2.5.4.10</b> <b>GEN-Panel</b> INTERVAL
<b>SOURCE:INTERval:MODE</b>	<b>CW</b>   <b>FIX</b> ed <b>SWE</b> ep1 <b>SWE</b> ep2 <b>LIST1</b> <b>LIST2</b>	<b>2.5.4.2</b> <b>GEN-Panel</b> SWEEP CTRL X Axis Z Axis

Command	Parameter	Section
<b>SOURCE:INTERVAL:START</b>	<nu> Value range and units determined by instrument or function	2.5.4.1.3 2.5.4.5 2.5.4.6 GEN-Panel Start
<b>SOURCE:INTERVAL:STOP</b>	<nu> Value range and units determined by instrument or function	2.5.4.1.3 2.5.4.5 2.5.4.6 GEN-Panel Stop
<b>SOURCE:INTERVAL[:CW FIXed]</b>	<nu> Value range and units determined by instrument or function	2.5.4.5 2.5.4.6 GEN-Panel INTERVAL
<b>SOURCE:LIST:DWELL</b>	<n>{,<n>}	2.9.1.3 No manual control
<b>SOURCE:LIST:DWELL:CONTROL:POINTS?</b>	<n> 0 to 1023 Query only	2.9.1.3 No manual control
<b>SOURCE:LIST:DWELL:CONTROL[:DATA]</b>	<n>{,<n>}	2.9.1.3 No manual control
<b>SOURCE:LIST:DWELL:POINTS?</b>	<n> 0 to 1023 Query only	2.9.1.3 No manual control
<b>SOURCE:LIST:FREQUENCY</b>	<n>{,<n>}	2.9.1.3 No manual control
<b>SOURCE:LIST:FREQUENCY:POINTS?</b>	<n> 0 to 1023 Query only	2.9.1.3 No manual control
<b>SOURCE:LIST:INTERVAL</b>	<n>{,<n>}	2.9.1.3 No manual control
<b>SOURCE:LIST:INTERVAL:POINTS?</b>	<n> 0 to 1023 Query only	2.9.1.3 No manual control
<b>SOURCE:LIST:ONTime</b>	<n>{,<n>}	2.9.1.3 No manual control
<b>SOURCE:LIST:ONTime:POINTS?</b>	<n> 0 to 1023 Query only	2.9.1.3 No manual control
<b>SOURCE:LIST:VOLTage</b>	<n>{,<n>}	2.9.1.3 No manual control

Command	Parameter	Section
<b>SOURce:LIST:VOLTage:POINTs?</b>	<n> 0 to 1023 Query only	<b>2.9.1.3</b> <b>No manual control</b>
<b>SOURce:LOWDistortion</b>	<b>ON</b> <b>OFF</b>	<b>2.5.4.1</b> <b>2.5.4.3</b> <b>GEN-Panel</b> Low Dist → ON → OFF
<b>SOURce:MULTisine:COUNT</b>	<n> 1 to 17	<b>2.5.4.4</b> <b>GEN-Panel</b> No of Sine
<b>SOURce:MULTisine:MODE</b>	<b>EQU</b> alvoltage <b>DEF</b> inedvoltage	<b>2.5.4.4</b> <b>GEN-Panel</b> Mode → EQUAL VOLT → DEFINE VOLT
<b>SOURce:O33</b>	'O33 ID code'	<b>No manual control</b>
<b>SOURce:OFF:MODE</b>	<b>SWE</b> ep2   <b>LIST</b> 2	<b>2.5.4.2</b> <b>GEN-Panel</b> Z Axis → OFF
<b>SOURce:ONTime</b>	<nu> tmin to tmax Analog generator: tmin= 20.83 μs Digital generator: tmin= 1 / sample frequency tmax: 60 s – tmin	<b>2.5.4.4</b> <b>2.5.4.9</b> <b>2.5.4.10</b> <b>GEN-Panel</b> ON TIME
<b>SOURce:ONTime:DELay</b>	<nu> 0 to 60 s	<b>2.5.4.5</b> <b>2.5.4.6</b> <b>GEN-Panel</b> BurstOnDel
<b>SOURce:ONTime:MODE</b>	<b>CW</b>   <b>FIX</b> ed <b>SWE</b> ep1 <b>SWE</b> ep2 <b>LIST</b> 1 <b>LIST</b> 2	<b>2.5.4.2</b> <b>GEN-Panel</b> SWEEP CTRL X Axis Z Axis
<b>SOURce:ONTime:STARt</b> <b>SOURce:ONTime:STOP</b>	<nu> Value range and units determined by instrument or function	<b>2.5.4.2</b> <b>2.5.4.5</b> <b>2.5.4.6</b> <b>GEN-Panel</b> Start Stop
<b>SOURce:ONTime[:CW FIXed]</b>	<nu> Value range and units determined by instrument or function	<b>2.5.4.5</b> <b>GEN-Panel</b> ON TIME

Command	Parameter	Section
<b>SOURce:PHASe</b>	<b>&lt;nu&gt;</b> 0 ° to 360 °	<b>2.5.4.13</b> <b>GEN-Panel</b> Phas Ch2:1
<b>SOURce:PHASe[&lt;i&gt;]:ADJust]</b>	<b>&lt;i&gt;</b> 1 to 17 <b>&lt;nu&gt;</b> 0 to 360 °	<b>2.5.4.4</b> <b>GEN-Panel</b> Phas No 1 to 17
<b>SOURce:PROTOcol</b>	<b>OFF</b> <b>STATic</b> <b>ENHanced</b>	<b>2.5.3.2</b> <b>ANA-Panel</b> PROTOCOL → PANEL OFF → STATIC → ENHANCED
<b>SOURce:PROTOcol:RCHannelstatus</b>	<b>ZERO</b> <b>LEQual</b> <b>AES3</b> <b>CRC</b> <b>RAW</b>	<b>2.5.3.2</b> <b>GEN-Panel</b> Ch Stat. R → ZERO → EQUAL L → FILE+AES3 → FILE+CRC → FILE
<b>SOURce:PROTOcol:UMODE</b>	<b>ZERO</b> <b>FILE</b>	<b>2.5.3.2</b> <b>GEN-Panel</b> User Mode → ZERO → FILE DEF
<b>SOURce:RANDom:DOMain</b>	<b>FREQuency</b> <b>TIME</b>	<b>2.5.4.9</b> <b>GEN-Panel</b> Domain → FREQ → TIME
<b>SOURce:RANDom:FREQuency:LOWer</b> <b>SOURce:RANDom:FREQuency:UPPer</b>	<b>&lt;nu&gt;</b> Value range and units determined by instrument or function	<b>2.5.4.9</b> <b>GEN-Panel</b> Lower Freq Upper Freq
<b>SOURce:RANDom:PDF</b>	<b>GAUSSian</b> <b>TRIangle</b> <b>RECTangle</b>	<b>2.5.4.1.1</b> <b>2.5.4.9</b> <b>GEN-Panel</b> PDF → GAUSS → TRIANGLE → RECTANGLE
<b>SOURce:RANDom:SHAPe</b>	<b>WHITe</b> <b>PINK</b> <b>TOCTave</b> <b>ARBITrary</b>	<b>2.5.4.9</b> <b>GEN-Panel</b> Equalizatn → WHITE → PINK → THIRD OCT → FILE

Command	Parameter	Section
<b>SOURce:RANDom:SPACing:FREQUency</b>	<nu> Lower limit value: analog = 2.93 Hz digital = sampling frequency / 16384	2.5.4.4 2.5.4.9 GEN-Panel Spacing
<b>SOURce:RANDom:SPACing:MODE</b>	ATRAck USERdefined	2.5.4.4 2.5.4.9 GEN-Panel Spacing → ANLR TRACK → USER DEF
<b>SOURce:SINusoid:DITHer</b>	<nu> 0 to 1 FS	2.5.4.1.1 GEN-Panel Dither
<b>SOURce:SINusoid:DITHer:STATe</b>	ON OFF	2.5.4.1.1 GEN-Panel Dither → ON → OFF
<b>SOURce:SWEep ...</b>		3.10.1.4 GEN-Panel
<b>SOURce:SWEep:DWELl</b>	<nu> 10 ms to 1000 s	2.5.4.2 GEN-Panel Dwell
<b>SOURce:SWEep:FREQUency:POINTs</b>	<n> 2 to 1024	2.5.4.2 GEN-Panel Points
<b>SOURce:SWEep:FREQUency:SPACing</b>	LINear LOGarithmic	2.5.4.2 GEN-Panel Spacing
<b>SOURce:SWEep:FREQUency:STEP</b>	<nu>	2.5.4.2 GEN-Panel Step
<b>SOURce:SWEep:INTerval:POINTs</b>	<n> 2 to 1024	2.5.4.1.3 GEN-Panel Points
<b>SOURce:SWEep:INTerval:SPACing</b>	LINear LOGarithmic	2.5.4.1.3 GEN-Panel Spacing → LIN → LOG
<b>SOURce:SWEep:INTerval:STEP</b>	<nu> Value range and units determined by instrument or function	2.5.4.1.3 GEN-Panel Step
<b>SOURce:SWEep:MODE</b>	MANual AUTO	2.5.4.2 GEN-Panel Sweep Ctrl



Command	Parameter	Section
<b>SOURce:SWEEp:NEXTstep</b>	<b>DWELL</b> <b>ASYNc</b> <b>LIST</b>	<b>2.5.4.2</b> <b>GEN-Panel</b> Next Step → ANLR SYNC → DWELL VALUE → DWELL FILE
<b>SOURce:SWEEp:ONTime:POINTS</b>	<n> 2 to 1024	<b>2.5.4.2</b> <b>GEN-Panel</b> Points
<b>SOURce:SWEEp:ONTime:SPACing</b>	<b>LINear</b> <b>LOGarithmic</b>	<b>2.5.4.2</b> <b>GEN-Panel</b> Spacing → LIN → LOG
<b>SOURce:SWEEp:ONTime:STEP</b>	<nu> Value range and units determined by instrument or function	<b>2.5.4.1.3</b> <b>GEN-Panel</b> Step
<b>SOURce:SWEEp:VOLTage:POINTS</b>	<n> 2 to 1024	<b>2.5.4.2</b> <b>GEN-Panel</b> Points
<b>SOURce:SWEEp:VOLTage:SPACing</b>	<b>LINear</b> <b>LOGarithmic</b>	<b>2.5.4.2</b> <b>GEN-Panel</b> Spacing → LIN → LOG
<b>SOURce:SWEEp:VOLTage:STEP</b>	<nu> Value range and units determined by instrument or function	<b>2.5.4.2</b> <b>GEN-Panel</b> Step
<b>SOURce:VOLTage:AM</b>	<nu>  -100% to 0%	<b>2.5.4.4</b> <b>2.5.4.9</b> <b>2.5.4.10</b> <b>GEN-Panel</b> Variation
<b>SOURce:VOLTage:CH2Stereo</b>	<nu> 0 to 1 FS	<b>2.5.4.13</b> <b>GEN-Panel</b> VOLT Ch2
<b>SOURce:VOLTage:CREStfactor</b>	<n> 1 to 100	<b>2.5.4.4</b> <b>GEN-Panel</b> Crest Fact
<b>SOURce:VOLTage:CREStfactor:MODE</b>	<b>MINimized</b> <b>DPHase</b> <b>VALue</b>	<b>2.5.4.4</b> <b>GEN-Panel</b> Crest Fact → OPTIMIZED → DEFINE PHAS → VALUE
<b>SOURce:VOLTage:EQUalize:POINTS?</b>	<n> 0 to 1023 Query only	<b>2.9.1.3</b> <b>No manual</b> <b>control</b>

Command	Parameter	Section
<b>SOURce:VOLTage:EQUalize:STATe</b>	ON OFF	2.5.4.1.1 2.5.4.4 2.5.4.3 <b>GEN-Panel</b> Equalizer → ON → OFF
<b>SOURce:VOLTage:EQUalize[:DATA]</b>	<n>{,<n>}	<b>2.9.1.3</b> <b>No manual control</b>
<b>SOURce:VOLTage:LIMit[:AMPLitude]</b>	<nu> 0 to 20 V 0 to 1 FS	<b>2.5.2</b> <b>GEN-Panel</b> For Volt Range = AUTO, Max Volt is displayed, for Volt Range = FIX, a numeric value.
<b>SOURce:VOLTage:LOWLevel</b>	<nu> 0 to SOUR:VOLT	<b>2.5.4.5</b> <b>GEN-Panel</b> Low Level
<b>SOURce:VOLTage:MODE</b>	CW   FIXed SWEep1 SWEep2 LIST1 LIST2	<b>2.5.4.2</b> <b>GEN-Panel</b> SWEEP CTRL X Axis Z Axis
<b>SOURce:VOLTage:MODE</b>	FIX	<b>2.5.4.16</b> <b>GEN Panel</b> Vari Mode → VOLTAGE
<b>SOURce:VOLTage:RANGE:AUTO</b>	ON OFF	<b>2.5.2</b> <b>GEN-Panel</b> Volt Range → AUTO → FIX
<b>SOURce:VOLTage:RATio</b>	<n> 1 to 10	<b>2.5.4.7</b> <b>2.5.4.13</b> <b>GEN-Panel</b> VOLT LF:UF or Volt Ch2:1
<b>SOURce:VOLTage:REFerence</b>	<nu> 1 mV to 1 MV	<b>2.5.2</b> <b>GEN-Panel</b> Ref.Volt
<b>SOURce:VOLTage:SELect</b>	VLRT VLVL	<b>2.5.4.13</b> <b>GEN-Panel</b> Volt Mode VOLT&RATIO VOLT CH1&2

Command	Parameter	Section
<b>SOURce:VOLTage:START</b>	<b>&lt;nu&gt;</b> Value range determined by instrument or function	<b>2.5.4.2</b> <b>GEN-Panel</b> VOLTAGE → Start
<b>SOURce:VOLTage:STOP</b>	<b>&lt;nu&gt;</b> Value range determined by instrument or function	<b>2.5.4.2</b> <b>GEN-Panel</b> VOLTAGE → Stop
<b>SOURce:VOLTage:TOTAL:GAIN</b>	<b>&lt;nu&gt;</b>	<b>2.5.4.4</b> <b>GEN-Panel</b> TOTAL GAIN
<b>SOURce:VOLTage:TOTAL:RMS?</b>	<b>&lt;nu&gt;</b> 0 V to 20 V	<b>2.5.4.4</b> <b>2.5.4.9</b> <b>2.5.4.10</b> <b>GEN-Panel</b> TOTAL RMS
<b>SOURce:VOLTage:TOTAL[:LEVel AMPLitude]</b>	<b>&lt;nu&gt;</b> Value range determined by instrument or function	<b>2.5.4.4</b> Query only <b>2.5.4.7</b> <b>2.5.4.8</b> <b>2.5.4.9</b> <b>2.5.4.10</b> <b>2.5.4.15</b> <b>GEN-Panel</b> TOTAL VOLT
<b>SOURce:VOLTage:TOTAL[:LEVel AMPLitude]</b>	<b>&lt;new&gt;</b> 1 $\mu$ FS to 1 FS or -120 dBFS to 0 dBFS	<b>2.5.4.16</b> <b>GEN Panel</b> TOTAL VOLT
<b>SOURce:VOLTage[:LEVel AMPLitude]</b>	<b>&lt;nu&gt;</b> 0 to 12 V 0 to 24 V 0 to 1 FS	<b>2.5.4.3</b> <b>2.5.4.5</b> <b>2.5.4.6</b> <b>2.5.4.11</b> <b>2.5.4.12</b> <b>2.5.4.13</b> <b>GEN-Panel</b> VOLTAGE or VOLT Ch1
<b>SOURce:VOLTage[:LEVel AMPLitude]:OFFSet</b>	<b>&lt;n&gt;</b> -5 V to 5 V -10 V to 10 V -1 FS to 1 FS	<b>2.5.4.1.1</b> <b>GEN-Panel</b> DC Offset
<b>SOURce:VOLTage[:LEVel AMPLitude]:OFFSet:STATe</b>	<b>OFF</b> <b>ON</b>	<b>2.5.4.1.1</b> <b>GEN-Panel</b> DC Offset → OFF → ON

Command	Parameter	Section
<b>SOURce:VOLTage</b> [<i>]:[:LEVel AMPLitude]	<i> 1 to 17 <nu> Analog instr.: OUTP:TYPE UNB 0 to 10 V Analog instr.: OUTP:TYPE BAL 0 to 20 V Digital instrument: 0 to 1 FS	<b>2.5.4.4</b> <b>GEN-Panel</b> Volt No 1 to 17
<b>SOURce:VOLTage2</b>	<nu> 0 to 5 V 0 to 6V 0 to 0.5 FS	2.5.4.14 <b>GEN-Panel</b> Carr Volt
<b>SOURce2:FREQuency:MODE</b>	<b>CW   FIXEd</b> <b>SWEep1</b> <b>LIST1</b>	<b>2.5.4.2</b> Sweeps <b>GEN-Panel</b> AUX GEN: SWEEP CTRL X Axis
<b>SOURce2:FREQuency:STARt</b>	<nu> 10 Hz to 110 kHz	<b>2.5.4.2</b> Sweeps <b>GEN-Panel</b> AUX GEN: FREQUENCY Start
<b>SOURce2:FREQuency:STOP</b>	<nu> 10 Hz to 110 kHz	<b>2.5.4.2</b> Sweeps <b>GEN-Panel</b> AUX GEN: FREQUENCY Stop
<b>SOURce2:FREQuency</b> [:CW FIXEd]	<nu> 10 Hz to 110 kHz	<b>2.5.5</b> <b>GEN-Panel</b> Abhängig von AUX GEN: → Anlg Freq → Comm Freq → JittPkFreq
<b>SOURce2:FUNCTION</b>	<b>OFF</b> <b>ANLGout</b> <b>COMMOn</b> <b>JITTer</b>	<b>2.5.5</b> <b>GEN-Panel</b> <b>AUX GEN:</b> → OFF → ANALOG OUT → COMMON MODE → JITTER
<b>SOURce2:SWEep ...</b>		<b>2.5.4.2</b> Sweeps <b>GEN-Panel</b> AUX GEN:
<b>SOURce2:SWEep:DWELl</b>	<nu> 10 ms to 1000 s	<b>2.5.4.2</b> Sweeps <b>GEN-Panel</b> AUX GEN: Dwell

Command	Parameter	Section
<b>SOURce2:SWEEp:FREQuency:POINts</b>	<n> 2 to 1024	<b>2.5.4.2</b> Sweeps <b>GEN-Panel</b> AUX GEN: FREQUENCY Points
<b>SOURce2:SWEEp:FREQuency:SPACing</b>	<b>LIN</b> ear <b>LOG</b> arithmic	<b>2.5.4.2</b> Sweeps <b>GEN-Panel</b> Spacing → LIN → LOG
<b>SOURce2:SWEEp:FREQuency:STEP</b>	<nu> depending on START and STOP	<b>2.5.4.2</b> Sweeps <b>GEN-Panel</b> AUX GEN FREQUENCY Step
<b>SOURce2:SWEEp:MODE</b>	<b>MAN</b> ual <b>AUTO</b>	<b>2.5.4.1.3</b> <b>GEN-Panel</b> AUX GEN Sweep Ctrl
<b>SOURce2:SWEEp:NEXTstep</b>	<b>DWEL</b> <b>ASYN</b> <b>LIST</b>	<b>2.5.4.2</b> Sweeps <b>GEN-Panel</b> AUX GEN: Next Step → ANLR SYNC → DWELL VALUE → DWELL FILE
<b>SOURce2:SWEEp:VOLTage:POINts</b>	<n> 2 to 1024	<b>2.5.4.2</b> Sweeps <b>GEN-Panel</b> AUX GEN VOLTAGE   AMPL Points
<b>SOURce2:SWEEp:VOLTage:SPACing</b>	<b>LIN</b> ear <b>LOG</b> arithmic	<b>2.5.4.2</b> Sweeps <b>GEN-Panel</b> VOLTAGE   AMPL AUX GEN: ANALOG Spacing → LIN → LOG
<b>SOURce2:SWEEp:VOLTage:STEP</b>	<nu> depending on START and STOP	<b>2.5.4.2</b> Sweeps <b>GEN-Panel</b> AUX GEN VOLTAGE   AMPL Step
<b>SOURce2:VOLTage:MODE</b>	<b>CW</b>   <b>FIX</b> ed <b>SWEEp1</b> <b>LIST1</b>	<b>2.5.4.2</b> Sweeps <b>GEN-Panel</b> AUX GEN SWEEP CTRL X Axis



Command	Parameter	Section
<b>STATus:QUEStionable:PTRansition</b>	<n>	<b>3.7.3.5</b> No manual control
<b>STATus:QUEStionable[:EVENT]?</b>	<n> Query only	<b>3.7.3.5</b> No manual control
<b>STATus:XQUEStionable:COND?</b>	<n> Query only	<b>3.7.3.6</b> No manual control
<b>STATus:XQUEStionable:ENABLE</b>	<n>	<b>3.7.3.6</b> No manual control
<b>STATus:XQUEStionable:NTRansition</b>	<n>	<b>3.7.3.6</b> No manual control
<b>STATus:XQUEStionable:PTRansition</b>	<n>	<b>3.7.3.6</b> No manual control
<b>STATus:XQUEStionable[:EVENT]?</b>	<n> Query only	<b>3.7.3.6</b> No manual control
<b>SYSTem:AHARdware:VERSion?</b>	<b>ABOard</b> <b>ACODE</b> Query only  Query: SYST:AHAR:VERS? ABO SYST:AHAR:VERS? ACOD The response is either the number of a version (eg 0.01) or -NA- (Not Available) if the board is not installed.	<b>2.15.7</b> <b>OPTIONS-Panel</b> VERSIONS ----- Anlg Board code
<b>SYSTem:BEEPer:STATe</b>	<b>ON</b> <b>OFF</b>	<b>2.15.2</b> <b>OPTIONS-Panel</b> Beeper → ON → OFF
<b>SYSTem:COMMunicate:GPIB:ADDRESS</b>	<n> 0 to 31	<b>2.15.1</b> <b>OPTIONS-Panel</b> UPL IECadr
<b>SYSTem:COMMunicate:GTL</b>		<b>LOCAL-</b> <b>Tastendruck</b>
<b>SYSTem:COMMunicate:SERial2: CONTROL</b>	<b>RTS</b> <b>XON</b>	<b>2.15.1</b> <b>OPTIONS-Panel</b> Handshake → RTS/CTS → XON/XOFF

Command	Parameter	Section
<b>SYSTem:COMMunicate:SERial2: FEED:BITS</b>	<n> n = 7   8	2.15.1 <b>OPTIONS-Panel</b> Data Bits → 7 → 8
<b>SYSTem:COMMunicate:SERial2:FEED:BAUD</b>	<n>  n = <b>2400</b> <b>3600</b> <b>4800</b> <b>7200</b> <b>9600</b> <b>19200</b> <b>38400</b> <b>56000</b>	2.15.1 <b>OPTIONS-Panel</b> Baud Rate → 2400 Baud → 3600 Baud → 4800 Baud → 7200 Baud → 9600 Baud → 19200 Baud → 38400 Baud → 56000 Baud
<b>SYSTem:COMMunicate:SERial2:FEED:PARity[:TYPE ]</b>	<b>NONE</b> <b>EVEN</b> <b>ODD</b>	2.15.1 <b>OPTIONS-Panel</b> Parity → NONE → EVEN → ODD
<b>SYSTem:COMMunicate:SERial2:FEED:SBITS</b>	<n> n = 1   2	2.15.1 <b>OPTIONS-Panel</b> Stop Bits → 1 → 2
<b>SYSTem:DHARdware:VERSion?</b>	<b>CPU</b> board <b>DBO</b> ard Query only  Query: SYST:DHAR:VERS? CPU SYST:DHAR:VERS? DBO The response is the number of a version (eg 0.05).	2.15.7 <b>OPTIONS-Panel</b> VERSIONS ----- CPU Board Dig. Board
<b>SYSTem:DISPlay:READing:RATE</b>	<b>MAX</b> speed <b>FST</b> speed <b>MED</b> speed <b>SLW</b> speed	2.15.5 <b>OPTIONS-Panel</b> Read Rate → MAX SPEED → 6/s → 3/s → 1/s
<b>SYSTem:DISPlay:READing:RESolution</b>	<n>	2.15.5 <b>OPTIONS-Panel</b> Read Resol
<b>SYSTem:DISPlay:TRACe[:LOAD</b>	<b>MAN</b> ual <b>DEF</b> ault <b>ACO</b> Lor <b>ALIN</b> e	<b>2.15.5.4</b> <b>OPTIONS-Panel</b> Scan conf → MANUAL → DEFAULT → AUTO COLOR → AUTO LINE



Command	Parameter	Section
<b>SYSTem:DISPlay:TRACe[1 2]:COLor</b>	<b>GREen</b> <b>YELLow</b> <b>BLUE</b> <b>CYAN</b> <b>MAGenta</b> <b>WHITe</b>  <b>BLACK</b> <b>DGRay</b> <b>LGRay</b>	<b>2.15.5.4</b> <b>OPTIONS-Panel</b> Color (A) / (B) → GREEN → YELLOW → BLUE → CYAN → MAGENTA → WHITE  → BLACK → DARK GRAY → LIGHT GRAY
<b>SYSTem:DISPlay:TRACe[1 2]:LINE</b>	<b>SSOLid</b> <b>SD</b> <b>SP</b> <b>SPD</b> <b>DSOLid</b> <b>DD</b> <b>DP</b> <b>DPD</b>	<b>2.15.5.4</b> <b>OPTIONS-Panel</b> Line (A) / (B) → _____ → - - - - - → . . . . . → . - . - . → = = = = = → = = = = = → : : : : : → : = : = : =
<b>SYSTem:DISPlay:TRACe[1 2]:SELEct</b>	<b>&lt;n&gt;</b> 1 to 17	<b>2.15.5.4</b> <b>OPTIONS-Panel</b> Scannr.(A) Scannr.(B)
<b>SYSTem:ERRor?</b>	<b>&lt;n&gt;</b> Query only	3.3.2 <b>No manual control</b>
<b>SYSTem:INFOtext:STATe</b>	<b>ON</b> <b>OFF</b>	2.9.1.1 <b>FILE-Panel</b> Info Displ → ON → OFF
<b>SYSTem:KEY:RDELay</b>	<b>&lt;nu&gt;</b> 0.25 to 1.0 s	<b>2.15.3</b> <b>OPTIONS-Panel</b> Rep Delay
<b>SYSTem:KEY:RRATe</b>	<b>&lt;nu&gt;</b> 0 to 50 Hz	<b>2.15.3</b> <b>OPTIONS-Panel</b> Reptn Rate
<b>SYSTem:LSPeed</b>	<b>FAST</b> <b>SLOW</b>	<b>No manual control</b>

Command	Parameter	Section
<b>SYSTem:OPTions:VERSion?</b>	<b>LDG</b> alias <b>B1</b> <b>REMOte</b> alias <b>B4</b> <b>DAUDio</b> alias <b>B2 B29</b> <b>SPEaker</b> alias <b>B5</b> <b>DAPR</b> otocol alias <b>B21</b> <b>DAJ</b> itter alias <b>B22</b> <b>SQCO</b> ntrol alias <b>B10</b> <b>B33</b> <b>B6</b> <b>B8</b>  Query only Query-Form e. g.: SYST:OPT:VERS? LDG  The response is either the number of an option (eg 0.01), INST or -NA- (Not Available) if the board or option are not installed.	<b>2.15.7</b> <b>2.6.6</b> <b>OPTIONS-Panel</b> OPTIONS ----- B1 Low Dist B4 Rem Ctrl B2 DigAudio B5 Speaker B21 DA Prot B22 DA Jitt B10 Seq Ctrl ITU-T O33 B6 Coher B8 PhoneTst
<b>SYSTem:PARAmeter:LINK</b>	<n> 0 to 2047	<b>2.15.7</b> <b>OPTIONS-Panel</b> Param. Link
<b>SYSTem:PHONE</b>	<b>SPKC</b> <b>PERM</b>	<b>2.6.6</b> <b>ANLR-Panel</b> Phone Out → SPKPhone → PERMANENT
<b>SYSTem:PRINt</b>	<b>TRACe1</b> <b>TRACe2</b> <b>EQU</b> alize <b>ERR</b> ors <b>DWELI</b> <b>LIM</b> Lower <b>LIM</b> Upper <b>LIST1</b> <b>LIST2</b> <b>TR1</b> And2 <b>OFF</b>	<b>2.14.5</b> <b>OPTIONS-Panel</b> PRINT Type → TRACE A → TRACE B → EQUALIZATN → LIM REPORT → DWELL VALUE → LIM LOWER → LIM UPPER → X AXIS → Z AXIS → TRACE A+B → OFF
<b>SYSTem:PROGram:EXECute</b>	'filename'	2.16 <b>OPTIONS-Panel</b> Exec Macro <filename>
<b>SYSTem:PROGram:POINts?</b>	<n> 0 to 1024 Query only	<b>No manual control</b>
<b>SYSTem:PROGram[:DATA]</b>	<n>{,<n>}	<b>No manual control</b>

Command	Parameter	Section
<b>SYSTem:SOFTware:VERSion?</b>	<b>SOFTware</b> <b>SETUp</b> Query only  Query: SYST:SOFT:VERS? SOFT SYST:SOFT:VERS? SETU The response is the number of a version (e.g. 3.05).	<b>2.15.7</b> <b>OPTIONS-Panel</b> VERSIONS ----- Software Setup
<b>SYSTem:SPEaker:GAIN</b>	<b>&lt;nu&gt;</b> -120 to 120 dB	<b>2.6.6</b> <b>ANLR-Panel</b> Pre Gain
<b>SYSTem:SPEaker:SOURce</b>	<b>OFF</b> <b>INP1</b> <b>INP2</b> <b>IN1And2</b> <b>FNC1</b> <b>FNC2</b> <b>FN1And2</b> <b>AES1</b> <b>AES2</b> <b>AE1And2</b>	<b>2.6.6</b> <b>ANLR-Panel</b> <b>SPEAKER</b> → OFF → INPUT Ch1 → INPUT JITT → INPUT COMM → INPUT Ch2 → INPUT Ch1&2 → FUNCT Ch1 → FUNCT Ch2 → FUNCT Ch1&2 → DIG IN Ch1 → DIG IN Ch2 → DIG Ch1&2
<b>SYSTem:SPEaker:VOLume</b>	<b>&lt;nu&gt;</b> 0 to 100 %	<b>2.6.6</b> <b>ANLR-Panel</b> Skp Volume
<b>SYSTem:SPEaker[:STATe]</b>	<b>ON</b> <b>OFF</b>	<b>2.6.6</b> <b>ANLR-Panel</b> LOCAL-Taste
<b>SYSTem:VERSion?</b>	<b>&lt;n&gt;</b> Query only	<b>2.15.7</b> <b>No manual control</b>
<b>TRACe:POINts?</b>	<b>CREFerence1</b> Query only Query: TRAC:POIN? CREF1 Query response <n> = 0 to 1023	<b>2.9.1.3</b> <b>No manual control</b>
<b>TRACe:POINts?</b>	<b>CREFerence2</b> Query only Query: TRAC:POIN? CREF2 Query response: <n> = 0 to 1023	<b>2.9.1.3</b> <b>No manual control</b>

Command	Parameter	Section
<b>TRACe:POINts?</b>	<b>REFerence1</b> Query only Query: TRAC:POIN? REF1 Query response: <n> = 0 to 1023	<b>2.9.1.3</b> <b>No manual control</b>
<b>TRACe:POINts?</b>	<b>REFerence2</b> Query only Query: TRAC:POIN? REF2 Query response: <n> = 0 to 1023	<b>2.9.1.3</b> <b>No manual control</b>
<b>TRACe:POINts?</b>	<b>TRACe2</b> Query only Query: TRAC:POIN? TRAC2 Query response: <n> = 0 to 1023 Query only	<b>2.9.1.3</b> <b>No manual control</b>
<b>TRACe:POINts? LIST1</b>	<b>LIST1</b> Query only Query: TRAC:POIN? LIST1 Query response: <n> = 0 to 1023	<b>2.9.1.3</b> <b>No manual control</b>
<b>TRACe:POINts? LIST2</b>	<b>LIST2</b> Query only Query: TRAC:POIN? LIST2 Query response: <n> = 0 to 1023	<b>2.9.1.3</b> <b>No manual control</b>
<b>TRACe:POINts? TRACe1</b>	<b>TRACe1</b> Query only Query: TRAC:POIN? TRAC1 Query response: <n> = 0 to 1023 Query only	<b>2.9.1.3</b> <b>No manual control</b>
<b>TRACe[:DATA]</b>	<b>LIST1,&lt;n&gt;{,&lt;n&gt;}</b> Queryform: TRACe? LIST1	<b>2.9.1.3</b> <b>No manual control</b>
<b>TRACe[:DATA]</b>	<b>LIST2,&lt;n&gt;{,&lt;n&gt;}</b> Queryform: TRACe? LIST2	<b>2.9.1.3</b> <b>No manual control</b>
<b>TRACe[:DATA]</b>	<b>REFerence1,&lt;n&gt;{,&lt;n&gt;}</b> Queryform: TRACe? REF1	<b>2.9.1.3</b> <b>No manual control</b>

Command	Parameter	Section
TRACe[:DATA]	REFerence2,<n>{,<n>} Queryform: TRACe? REF2	2.9.1.3 No manual control
TRACe[:DATA]	TRACe1,<n>{,<n>} Queryform: TRACe? TRAC1	2.9.1.3 No manual control
TRACe[:DATA]	TRACe2,<n>{,<n>} Queryform: TRACe? TRAC2	2.9.1.3 No manual control
TRACe[:DATA] CREFerence1,	<n>{,<n>} Queryform: TRACe? CREF1	2.9.1.3 No manual control
TRACe[:DATA] CREFerence2,	<n>{,<n>} Queryform: TRACe? CREF2	2.9.1.3 No manual control
TRIGger:CHANnel	CH1 CH2 GENBurst	2.6.5.14 ANLR-Panel Trig Src → CHAN 1 → CHAN 2 → GEN BURST
TRIGger:COUNt	<nu> 2 to 1024	2.6.4 ANLR-Panel Points
TRIGger:DELay	<nu> 0 to 10 s	2.6.4 ANLR-Panel Delay
TRIGger:FREQUency:VARiation	<nu> > 0.1 to 50%	2.6.4 ANLR-Panel Variation
TRIGger:LEVel	<nu> Analog instruments -50 V to 50 V Digital instrument -1 FS to 1 FS	2.6.5.14 ANLR-Panel Trig Level
TRIGger:SLOPe	POSitive NEGative	2.6.5.14 ANLR-Panel Trig Slope → RISING → FALLING

Command	Parameter	Section
<b>TRIGger:SOURce</b>	<b>IMM</b> ediate <b>TIM</b> er <b>CH1</b> Freq <b>CH2</b> Freq <b>CH1</b> Level <b>CH2</b> Level <b>CH1</b> Trigger <b>CH2</b> Trigger <b>TCH</b> art <b>CH1</b> Rapidfreq <b>CH2</b> Rapidfreq <b>CH1</b> Edgetrigger <b>CH2</b> Edgetrigger	<b>2.6.4</b> <b>ANLR-Panel</b> START COND → AUTO → TIME → CH1Freq   CH2Freq → CH1Level   CH2Level → LEV TRG CH1   LEV TRG CH2 → TIME CHART → FRQ FST CH1 → FRQ FST CH2 → EDG TRG CH1 → EDG TRG CH2
<b>TRIGger:TIMer</b>	<b>&lt;nu&gt;</b> 10 ms to 2000 s	<b>2.6.4</b> <b>ANLR-Panel</b> Timetick
<b>TRIGger:VOLTage:VARiation</b>	<b>&lt;nu&gt;</b> > 0.1 ,900% oder > 0.01 to 20 dB	<b>2.6.4</b> <b>ANLR-Panel</b> Variation



## 3.12 IEC/IEEE-Bus Interface

The UPL is equipped with an IEC/IEEE-bus interface as a standard. The mating 25-pin connector according to standard IEC 625.1/IEEE 488 is at the rear of the instrument. A controller for remote control can be connected via the interface. Interconnection is made via a shielded cable.

### 3.12.1 Interface Characteristics

- 8-bit parallel data transfer
- bidirectional data transfer
- three line handshake
- high data transfer rate of max. 350 kByte/s
- up to 15 devices can be connected
- maximum length of interconnecting cable 15 m (single connection 2m)
- wired OR if several instruments are interconnected in parallel.

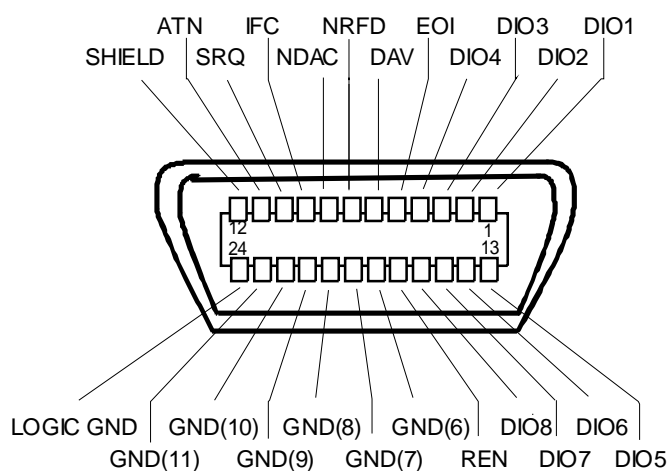

Fig. 3-7 Pin assignment of IEC/IEEE-bus interface

### 3.12.2 Bus Lines

#### 1. Data bus with 8 lines DIO 1 to DIO 8.

The transmission is bit-parallel and byte-serial in the ASCII/ISO code. DIO1 is the bit of lowest order, DIO8 the bit of highest order.

#### 2. Control bus with 5 lines.

**IFC** (Interface Clear),

active low resets the interfaces of all connected instruments to the default setting.

**ATN** (Attention),



active low signals the transmission of interface messages  
 inactive high signals the transmission of device-dependent messages.

**SRQ** (Service Request),

active low enables a device connected to send a service request to the controller.

**REN** (Remote Enable),

active low permits the switchover to remote control.

**EOI** (End or Identify),

has two functions in connection with ATN:

active low marks the end of data transmission with ATN = HIGH

active low triggers a parallel poll with ATN = LOW.

### 3. Handshake Bus mit drei Leitungen.

**DAV** (Data Valid),

active low signals a valid data byte on the data bus.

**NRFD** (Not Ready For Data),

active low signals that one of the devices connected is not ready for data transfer.

**NDAC** (Not Data Accepted),

active low as long as the instrument connected is accepting the data present on the data bus.

### 3.12.3 Interface Functions

Instruments which can be remote-controlled via IEC/IEEE bus can be equipped with different interface functions. Table A-1 lists the interface functions appropriate for the UPL.

Table 3-10 Interface functions

Control character	Interface function
SH1	Handshake source function (source handshake)
AH1	Handshake drain function (acceptor handshake)
L3..L4/LE3..LE4	Listener function.
T5..T8/TE5..TE8	Talker function, ability to respond to serial poll
SR1	Service request function
PP1	Parallel poll function
RL1	Remote/Local switchover function
DC1	Resetting function (Device Clear)
DT1	Trigger function (Device Trigger)
C1...C27	Controller function (with optional software UPL-B10only)

### 3.13 Interface Messages

Interface messages are transmitted to the UPL on the data lines, with the attention line being active (LOW). They enable the communication between instrument and controller. Das Parsen von Befehlen entfällt, dadurch wird eine hohe Verarbeitungsgeschwindigkeit erreicht.

#### 3.13.1 Common Commands

The common commands are encoded in the range 10 through 1F hex. They are effective for all instruments connected to the bus without addressing them before.

Table 3-11 Common commands

Command	BASIC command for R&S controllers	Effect on UPL
DCL (Device Clear)	IECDCL	Aborts the processing of the commands just received and sets the command processing software to a defined initial state. Does not change the instrument setting.
IFC (Interface Clear)	IECIFC	Resets the interfaces to the default setting.
LLO (Local Lockout)	IECLLO	The REM/LOCAL key is disabled.
SPE (Serial Poll Enable)	IECSPE	Ready for serial poll
SPD (Serial Poll Disable)	IECSPD	End of serial poll
PPU (Parallel Poll Unconfigure)	IECPPU	End of the parallel-poll state

#### 3.13.2 Addressed Commands

The addressed commands are encoded in the range 00 through 0F hex. They are only effective for instruments addressed as listeners.

Table 3-12 Addressed commands

Command	BASIC command for R&S controllers	Effect on UPL
SDC (Selected Device Clear)	IECLAD 20: IECSDC	Aborts the processing of the commands just received and sets the command processing software to a defined initial state. Does not change the instrument setting.
GET (Group Execute Trigger)	IECLAD 20: IECGET	Triggers all actions which are waiting for a trigger event. This command is identical with the commands INIT and *TRG.
GTL (Go to Local)	IECLAD 20: IECGTL	Transition to the "Local" state (manual control)
PPC (Parallel Poll Configure)	IEC PCON 20, 1, 6	Configure instrument for parallel poll In the command to the left, the UPL with an address of 20 is reporting a 1 on line 6.

### 3.14 List of Error Messages

The following list contains error messages which can be obtained via IEC/IEEE bus or in manual operation. Negative error numbers are SCPI-defined. The positive error number "111" marks device-specific errors.

#### When and how is the error queue output?

If the controller does not succeed in transmitting a command to UPL, an error message appears in the information line on the screen and a short signal can be heard.

This error message can be indicated in the control program by outputting the error queue after every command sent to UPL. This should be controlled by SRQ, i.e. only when bit 3 (Device Dependent Error), bit 4 (Execution Error) or bit 5 (Command Error) of the event status register is set, but can also happen at any location in the control program.

If no error has been detected, the message is  
0, "No Error"

Example:

```
1000Errqueue:
1010 IEC OUT 20,"SYST:ERR?":           ' Output error queue until it is empty!
1020 IEC IN 20,E$.                     ' Read error information
1030 IF LEFT$(E$,1)="0" THEN RETURN:   ' 0, "No Error", error queue empty!
1040 PRINT "Contents of error queue: "; E$:GOTO Errqueue
```

The table contains the error number in the left-hand column. In the right-hand column, the error text being entered into the error/event queue or being displayed is printed in bold face. Below the error text, there is an explanation as to the respective error.

#### 3.14.1 SCPI-Specific Error Messages

No Error

Error number	<b>Error query response</b> Explanation
0	<b>No error</b> This message is output if the error queue is completely empty.

### 3.14.2 Command Error

Command error — sets bit 5 in the ESR register.

Error number	Error query response Explanation
-100	<b>Command Error</b> The command is faulty or invalid.
-101	<b>Invalid Character</b> A syntactic element contains a character which is invalid for that type. Example: A header containing an ampersand, "SOURCE&".
-102	<b>Syntax error</b> An unrecognized command or data type was received. Example: A string was received when the device does not accept strings.
-103	<b>Invalid separator</b> The device was expecting a separator and received an illegal character. Example: The semicolon was omitted after a program message unit.
-104	<b>Data type error</b> The device recognized a data element different than one allowed. Example: Numeric or string data are expected but block data was received.
-105	<b>GET not allowed</b> A Group Execute Trigger (GET) was received within a program message.
-112	<b>Program mnemonic too long</b> The header contains more than 12 characters.
-113	<b>Undefined header</b> The header is syntactically correct, but it is undefined for the UPL. Example: *XYZ is not defined for any device.
-114	<b>Header suffix out of range</b> A nonheader character has been encountered in the header element parsed by the device. Example: SOURCE3 is not defined for any device.
-123	<b>Exponent too large</b> The magnitude of the exponent is larger than 320000.
-124	<b>Too many digits</b> The mantissa of a decimal numeric data element contains more than 255 digits (excluding leading zeros).
-128	<b>Numeric data not allowed</b> A legal numeric data element was received, but the device does not accept one in this position for the header. Example: Command SOURCE:FREQUENCY:MODE requires the indication of a text parameter.
-131	<b>Invalid suffix</b> The suffix is inappropriate for this device. Example: nHz is not defined?
-134	<b>Suffix too long</b> The suffix contains more than 12 characters.
-138	<b>Suffix not allowed</b> A suffix was received after a numeric element which does not allow suffixes. Example: Command *RCL does not permit indicating a suffix.
-141	<b>Invalid character data</b> Either the character data element contains an invalid character or the particular element received is not valid for the header. Example: Write error with parameter indication; SOURCE:FREQUENCY:MODE FIKSed.

Command error (cont.)

<b>Error number</b>	<b>Error query response</b> Explanation
-144	<b>Character data too long</b> The character data element contains more than 12 characters.
-148	<b>Character data not allowed</b> A legal character data element was encountered where prohibited by the device. Example: Command *RCL requires the indication of a number.
-151	<b>Invalid string data</b> A string data element was expected, but was invalid for some reason. Example: An END message was received before the terminal quote character.
-158	<b>String data not allowed</b> A legal string data element was encountered where prohibited by the device.
-161	<b>Invalid block data</b> A block data element was expected, but was invalid for some reason. Example: An END message was received before the length was satisfied.
-168	<b>Block data not allowed</b> A legal block data element was encountered where prohibited by the device.
-178	<b>Expression data not allowed</b> A legal expression data element was encountered where prohibited by the device.

### 3.14.3 Execution Error

Execution error — sets bit 4 in the ESR register.

<b>Error number</b>	<b>Error query response</b> Explanation
-200	<b>Execution error</b> An error occurred when executing a received command.
-220	<b>Parameter error</b> A program data element related error occurred.
-221	<b>Settings conflict</b> A legal program data element was parsed but could not be executed due to the current device state.
-222	<b>Data out of range</b> The received data element was syntactically correct but could not be executed because the value was outside the legal range as defined by the device. Example: Command TRIG:DEL only permits entries in the range of 50 ms to 10 sec.
-241	<b>Hardware missing</b> A legal program command or query could not be executed because of missing device hardware; for example, an option was not installed.

### 3.14.4 Device-Specific Error

Device-specific Error — sets bit 3 in the ESR register.

Error number	Error query response Explanation
-300	<b>Device-specific error</b> Generic device-dependent error for devices that cannot detect more specific errors.

### 3.14.5 Query Error

Query Error — sets bit 2 in the ESR register.

Error number	Error query response Explanation
-400	<b>Query error</b> Generic device-dependent query error for devices that cannot detect more specific errors.
-420	<b>Query UNTERMINATED</b> A condition causing an UNTERMINATED query error occurred. Example: The device was addressed to talk and an incomplete program message was received.
-430	<b>Query DEADLOCKED</b> A condition causing an DEADLOCKED query error occurred. Example: Both input buffer and output buffer are full and the device cannot continue.

### 3.14.6 UPL-Specific Error Messages

Device-specific Error — sets bit 3 in the ESR register.

Error number	Error query response Explanation
111	After the error queue has been output, all device-dependent errors are shown with the code number 111 and a self-explanatory text having a maximum length of 50 characters, e.g. 111, „Device dep. error; Insufficient disk space! Cannot write file“.

## 3.15 Examples of IEC/IEEE-Bus Programming (Hints and Program Examples)

The examples illustrate UPL programming and may be taken as a basis for solving more complex programming tasks.

All programming examples for IEC/IEEE-bus control in the path C:\UPL\IEC EXAM\EXAM1.BAS ff and those of the UPL software are written in R&S BASIC.

These examples can be run directly on a controller using a suitable IEC/IEEE-bus card and R&S BASIC (see (siehe 3.15.1, R&S BASIC). Files with the extension .SAC are setup files requiring the program examples for setting the UPL. Files with the extension .TXT give the program code of the examples as ASCII file so that they can be accessed with any editor.

If other languages are used for controlling the UPL by means of IEC/IEEE commands, the given sequence of commands may be used but for a few exceptions, as it is independent of the programming language.

### 3.15.1 R&S BASIC

The following program routines and examples and those contained in the UPL software are ready for use provided R&S BASIC and the R&S IEC/IEEE-bus card have been installed in the controller.

**Note:**

*R&S BASIC and the R&S IEC/IEEE-bus interface card may be ordered from your local sales engineer under the designation **PAT-B1, Order No. 1007.1150.02.***

### 3.15.2 IEC/IEEE-Bus Control after Power-Up

After UPL power-up, messages may be displayed which have to be acknowledged using the ENTER or CANCEL key. If the instrument is to be remote-controlled after power-up irrespective of any messages displayed, it is recommended to start the UPL with the aid of the command line parameter "-r". In this case messages do not require to be acknowledged by a keystroke, the UPL is started with a suitable setup and immediately ready for remote control.

Example: C:\UPL\UPL\_UI-r <CR>

### 3.15.3 Command Logging - Converting UPL-B10 Commands into IEC/IEEE-Bus Commands

All commands required for setting the UPL or for measurements are listed in section **3.10 IEC-bus Commands** and section **3.11 Alphabetical List of IEC-bus Commands** of the UPL manual. To avoid a tedious search for the commands required, the Universal Sequence Controller, UPL-B10, which is simply called *B10* below and available as an option, permits all manual setting procedures to be stored as *B10* commands and to be converted into the IEC/IEEE-bus control program.

**Note:**

*The Universal Sequence Controller option UPL-B10 may be ordered from your local sales engineer under the **Order No. 1078.3856.02.** For installation please refer to the Installation Instruction enclosed with Option UPL-B10.*

The procedure is explained by way of a sweep with subsequent display of the sweep curve:

- Prior to recording the desired command sequence, press key F2 to activate command logging ("logging on" displayed at bottom right). All settings performed subsequently in the UPL are recorded as a sequence of B10 commands.
- When the setting sequence has been completed, disable command logging by pressing the F2 key again ("logging off" displayed at bottom right).
- Call up the B10 program by pressing F3. Upon pressing F8 (LISTe), a list of commands is displayed - for the time being without comments - which has been generated by means of B10 commands and correspond to the settings just performed (in the example **Settings for a frequency sweep**).

```

10 UPL OUT  "*RST"
20 UPL OUT  "DISP:MODE COLB"
30 UPL OUT  "SENS:VOLT:APER:MODE AFAS"
40 UPL OUT  "SENS:FILT:AWE ON"
50 UPL OUT  "DISP:TRAC:OPER CURV"
60 UPL OUT  "DISP:TRAC:X:SPAC LOG"
70 UPL OUT  "SOUR:SWE:MODE AUTO;:SOUR:FREQ:MODE SWE1"

```

Listing of B10 commands without comments.  
Comments will be added manually later on.

- Use command ASAVE "A:LOGGING.TXT" to store the listing as ASCII file on a floppy disk.
- Return to the UPL operating level by pressing F3 and quit the UPL (CTRL+F9).
- Using an editor of your own choice at the DOS operating system level, edit the A:LOGGING.TXT file in a form suitable for IEC/IEEE-bus control by replacing |UPL OUT| by |IEC OUT 20,| and store it on the floppy disk.

```

10 IEC OUT 20, "*RST"
20 IEC OUT 20, "DISP:MODE COLB"
30 IEC OUT 20, "SENS:VOLT:APER:MODE AFAS"
40 IEC OUT 20, "SENS:FILT:AWE ON"
50 IEC OUT 20, "DISP:TRAC:OPER CURV"
60 IEC OUT 20, "DISP:TRAC:X:SPAC LOG"
70 IEC OUT 20, "SOUR:SWE:MODE AUTO;:SOUR:FREQ:MODE SWE1"

```

Listing of IEC/IEEE-bus commands without comments.  
Comments will be added manually later on!

- Establish connection to IEC/IEEE-bus controller and start R&S BASIC on the controller.
- Insert floppy holding the "LOGGING.TXT" file into the controller.
- Load the listing as ASCII file from the floppy with command ALOAD "A:LOGGING.TXT" and extend it as required by IEC/IEEE-bus-specific commands and comments.

```

10 IEC TERM 10:'          Controller waits for Line Feed as terminator
20 IEC TIME 10000:'      IEC/IEEE-bus timeout 10 s
30 IEC OUT 20, "*RST;*WAI":'          UPL default setup
40 IEC OUT 20, "DISP:MODE COLB":'      Changes of colour
50 IEC OUT 20, "SENS:VOLT:APER:MODE AFAS":'      High measurement speed
60 IEC OUT 20, "SENS:FILT:AWE ON":'      Switches on A-weighting filter
70 IEC OUT 20, "DISP:TRAC:OPER CURV":'      Selects trace display
80 IEC OUT 20, "DISP:TRAC:X:SPAC LOG":'      Logarithmic X axis
0 IEC OUT 20, "SOUR:SWE:MODE AUTO;:SOUR:FREQ:MODE SWE1":'      Autom. Sweep
100 IEC OUT 20, "DISP:CONF AP":'      Selects graphic window
110 IEC OUT 20, "INIT:CONT OFF;*WAI":'      Starts sweep and waits for end
120 IEC OUT 20, "DISP:TRAC:Y:AUTO ONCE":'      Autoscaling
130 IEC LAD 20: IEC GTL:'          Return to manual control
140 END

```

(listing of IEC/IEEE-bus commands with additional commands and comments)

- Start the ready-to-run program with RUN or F2.



### 3.15.4 Initialization and Default Status

The controller must be informed that the end character for query replies from the UPL is < Line Feed> and that it has to wait for max. 10 s after a trigger command or an IEC-IN command before it signals a timeout. The IEC/IEEE-bus Status Registers and the UPL are reset to the default state.

For default settings of UPL see annex **A UPL Default Setup**

```

10 'Initialization of controller
10 IEC TERM 10:'          Controller waits for Line Feed as terminator
20 IEC TIME 10000:'      After 10 s controller signals IEC/IEEE-bus timeout
10 'Initialization of UPL
20 IECOUT 20,"*CLS":'    Resets Status Register
30 IECOUT 20,"*RST;*WAI":' Resets device and waits for end of calibration
:
```

### 3.15.5 Sending Instrument Setting Commands

In this routine, the UPL is set to maximum speed for triggered measurements.

```

10 IEC TERM 10:'          Terminator for query replies is Line Feed
20 IEC TIME 10000:'      Max. waiting time for query replies is 10 s
30 IEC OUT 20,"*CLS":'    Resets IEC/IEEE-bus Status Register
40 IEC OUT 20,"*RST;*WAI":' UPL default setting, *WAI waits for calibr.
50 IEC OUT 20,"DISP:ANN OFF":' Switches off result display
60 IEC OUT 20,"SENS2:FUNC 'OFF'":' Switches off input-peak measurement
70 IEC OUT 20,"SENS3:FUNC 'OFF'":' Switches off frequency measurement
80 IEC OUT 20,"SENS:VOLT:APER:MODE VAL"
90 IEC OUT 20,"SENS:VOLT:APER 1ms":' Sets a measurement speed of 1 ms
:
```

### 3.15.6 Switchover to Manual Control

```

REM ----- Switching the instrument to manual control -----
:
100 IEC LAD 20:'  Addresses UPL
110 IEC GTL:'     Sets UPL to local
:
```

### 3.15.7 Readout of Instrument Settings

The settings made in section **3.15.5 Sending Instrument Setting Commands**, are read out. In this case the short form of the commands is used.

```

:
110 '----- Readout of instrument settings -----
120 IEC OUT 20,"DISP:ANN?":' Query for setting the display Update
130 IEC IN 20,A$: PRINT A$:' Displays OFF
140 IEC OUT 20,"SENS2:FUNC?":' Query for input peak measurement
150 IEC IN 20,A$: PRINT A$:' Displays OFF
160 IEC OUT 20,"SENS:VOLT:APER?":' Query for measurement speed
170 IEC IN 20,A$: PRINT A$:' Displays 1.E-3
:
```

### 3.15.8 Readout of Measurement Results

Numeric results of a specific measurement function, ie input peak, input RMS or frequency and phase measurements, can be taken from the UPL in a triggered or non-triggered form.

For triggering measurements and sweeps see section 3.6.7 **Triggering a Measurement/Sweep**

Waiting for the end of a measurement or sweep is described in section 3.6.8.2 **Wait for End of Measurement/Sweep.**

The display below gives the IEC/IEEE-bus commands used for selecting and calling up measurement results.

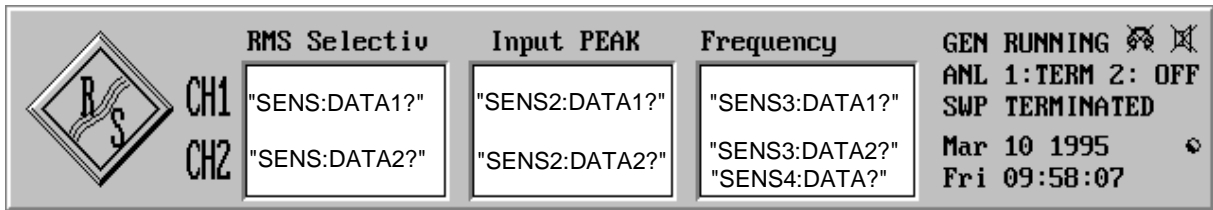

Fig. 3-8 Result display and associated IEC/IEEE-bus commands

Table 3-13 Selecting measurement results

Measurement function	Channel setting	Selection and readout of measurement results
<b>Function</b>	IECOUT 20, "INP:SEL CH1"	IECOUT 20, "SENS:DATA1?":IECIN 20,Func\$
IECOUT 20, "SENS:FUNC 'RMS' "	IECOUT 20, "INP:SEL CH2"	IECOUT 20, "SENS:DATA2?":IECIN 20,Func\$
"SENS:FUNC 'RMSS' " "SENS:FUNC 'PEAK' " "SENS:FUNC 'QPE' " "SENS:FUNC 'DC' " "SENS:FUNC 'THD' " "SENS:FUNC 'THDN' " "SENS:FUNC 'MDIST' " "SENS:FUNC 'DFD' " "SENS:FUNC 'DIM' " "SENS:FUNC 'WAF' " "SENS:FUNC 'POL' " "SENS:FUNC 'FFT' " "SENS:FUNC 'FILT' " "SENS:FUNC 'WAV' " "SENS:FUNC 'COHE' "	IECOUT 20, "INP:SEL CH1A" or IECOUT 20, "INP:SEL CH1I" or IECOUT 20, "INP:SEL CH2I" or IECOUT 20, "INP.SEL BOTH"	IECOUT 20, "SENS:DATA1?":IECIN 20,FuncA\$ IECOUT 20, "SENS:DATA2?":IECIN 20,FuncB\$
<b>Input PEAK or Input RMS</b>	IECOUT 20, "INP:SEL CH1"	IECOUT 20, "SENS2:DATA1?":IECIN 20,Ip\$
IECOUT 20, "SENS2:FUNC 'PEAK' " "SENS2:FUNC 'RMS' "	IECOUT 20, "INP:SEL CH2"	IECOUT 20, "SENS2:DATA2?":IECIN 20,Ip\$
	IECOUT 20, "INP:SEL CH1A" or IECOUT 20, "INP:SEL CH1I" or IECOUT 20, "INP:SEL CH2I" or IECOUT 20, "INP.SEL BOTH"	IECOUT 20, "SENS2:DATA1?":IECIN 20,IpA\$ IECOUT 20, "SENS2:DATA2?":IECIN 20,IpB\$
<b>Frequency measurement</b>	IECOUT 20, "INP:SEL CH1"	IECOUT 20, "SENS3:DATA1?":IECIN 20,Freq\$
IECOUT 20, "SENS3:FUNC 'FREQ' "	IECOUT 20, "INP:SEL CH2"	IECOUT 20, "SENS3:DATA2?":IECIN 20,Freq\$
	IECOUT 20, "INP:SEL CH1A" or IECOUT 20, "INP:SEL CH1I" or IECOUT 20, "INP:SEL CH2I" or IECOUT 20, "INP.SEL BOTH"	IECOUT 20, "SENS3:DATA1?":IECIN 20,FreqA\$ IECOUT 20, "SENS3:DATA2?":IECIN 20,FreqB\$

Measurement function	Channel setting	Selection and readout of measurement results
<b>Frequency and phase measurement</b> IECOUT 20, "SENS3:FUNC 'FQPH'" with two-channel measurements only	IECOUT 20,"INP:SEL CH1A" or IECOUT 20,"INP:SEL CH1I" or IECOUT 20,"INP:SEL CH2I" or IECOUT 20,"INP.SEL BOTH"	IECOUT 20,"SENS3:DATA1?":IECIN 20,Freq\$ IECOUT 20,"SENS4:DATA?":IECIN 20,Phas\$
<b>Frequency and group delay measurement</b> IECOUT 20, "SENS3:FUNC 'FQGR'" with two-channel measurements only	IECOUT 20,"INP:SEL CH1A" oder IECOUT 20,"INP:SEL CH1I" oder IECOUT 20,"INP:SEL CH2I" oder IECOUT 20,"INP.SEL BOTH"	IECOUT 20,"SENS3:DATA1?":IECIN 20,Freq\$ IECOUT 20,"SENS4:DATA?":IECIN 20,Grpl\$

### 3.15.8.1 Readout of Triggered Measurements

Readout of triggered measurement is demonstrated by way of an RMS measurement:

```

:
100 IEC OUT 20,"SENS:FUNC 'RMS'" : '           Sets RMS measurement
110 IEC OUT 20,"INPUT:SELECT CH1" : '         Sets channel 1
:
210 'One of three trigger modes can be selected
220 INPUT "Select trigger mode INIT [I], GET [G] or *TRG [T]:";Tg$
:
330 IEC OUT 20,"INIT:CONT OFF;*WAI" : '       Selects single-measurement mode
:
480 IF Tg$="I" THEN IEC OUT 20,"INIT" : GOTO In
490 IF Tg$="G" THEN IEC LAD 20: IEC GET :GOTO In
500 IF Tg$="T" THEN IEC OUT 20,"*TRG" : GOTO In
:
620In:
630 IEC OUT 20,"*WAI" : '           Sends next IEC/IEEE-bus command only after
640 '                               a result has been obtained.
650 IEC OUT 20,"SENS:DATA1?" : '       Selects result of channel 1
660 IEC IN 20,Mwert$ : '             Reads in measurement result
667 PRINT Mwert$ : '                 Outputs measurement result
:

```

### 3.15.8.2 Readout of Non-Triggered Measurements

Contrary to triggered measurements, results of non-triggered measurements are read from the buffer at maximum speed without considering settling so that the same value is displayed several times before a new value is output.

Since results of non-triggered measurements are read out as an exception, no detailed description will be given. Reading out triggered measurement results as described in section 3.15.8.1 **Readout of Triggered Measurements**, is to be preferred in any case.

```

:
190 IEC OUT 20,"*RST;*WAI":'           Sets up RMS measurement
200 IEC OUT 20,"DISP:ANN OFF":'       Switches off result display
210 IEC OUT 20,"SENS2:FUNC 'OFF'":'   Switches off PEAK measurement
220 IEC OUT 20,"SENS3:FUNC 'OFF'":'   Switches off frequency measurement
230 IEC OUT 20,"SENS:VOLT:APER:MODE AFAS":' Selects high measurement speed
240 IEC OUT 20,"INIT:CONT ON":'      Selects continuous measurements
250 IEC LAD 20: IEC GET :'           Triggers with Group Executive Trigger
260 '"*WAI" omitted!
270 IEC OUT 20,"SENS:DATA1?":'       Selects RMS result on channel 1
280 IEC IN 20,Mwert$: '              Reads in measurement result
:

```

### 3.15.9 Sweep Setting/Trigger

#### 3.15.9.1 Generator Sweep

With a generator sweep of the UPL, output frequency, output level, burst duration, etc. are swept between the start/stop values .

A sweep is triggered with INIT, \*TRG or GET (see section 3.6.7 **Triggering a Measurement/Sweep**).

```

:
50 IEC OUT 20,"SOUR:SWE:MODE AUTO;:SOUR:FREQ:MODE SWE1":'   Freq. sweep
60 IEC OUT 20,"SOUR:FREQ:STAR 100 HZ":'                     Sweep start frequency 100 Hz
70 IEC OUT 20,"SOUR:FREQ:STOP 10 KHZ":'                     Sweep stop frequency 10 kHz
80 IEC OUT 20,"SOUR:SWE:FREQ:POIN 15":'                     15 sweep points
90 IEC OUT 20,"SENS:FILT:AWE ON":'                           Selects A-weighting filter
100 IEC OUT 20,"DISP:TRAC:OPER CURV":'                       Selects trace display
110 IEC OUT 20,"INIT:CONT OFF;*WAI":' Triggers single sweep, waits for end
120 IEC OUT 20,"DISP:CONF AP":'                               Selects analyzer display with graphic window
130 IEC LAD 20: IEC GTL: '                                    Displays sweep curve
:

```

See also section 3.15.10.3 **Configuration for Maximum Sweep Speed** and 3.15.10.3.1 **Generator Sweep**.

### 3.15.9.2 External Sweep

With external sweep of UPL, measurement results are obtained by frequency and level variations at channel 1 or 2 of the analyzer input.

The example below illustrates an external frequency sweep.

```

:
300 '*** Setting parameters for external sweep
310 IEC OUT 20,"TRIG:SOUR CH1F": '          Setup for external frequency sweep
320 IEC OUT 20,"ARM:LEV:MIN 100 mV": '      Minimum level 100 mV
330 IEC OUT 20,"ARM:FREQ:STAR 100 Hz": '    Start frequency 100 Hz
340 IEC OUT 20,"ARM:FREQ:STOP 16 kHz": '    Stop frequency 16 kHz
350 IEC OUT 20,"TRIG:FREQ:VAR 4.5": '      Var. just below sweep step width
360 IEC OUT 20,"DISP:CONF AP": '          Selects graphic window
370 PRINT "External sweep is started - recording is in progress!"
380 IEC OUT 20,"INIT:CONT OFF;*WAI": '      Triggers external single sweep
390 IEC OUT 20,"SYST:BEEP:STAT ON": '      Waits for sweep end with dummy command
400 IEC LAD 20: IEC GTL : '                Displays curve
:

```

See also section 3.15.10.3 Configuration for Maximum Sweep Speed and 3.15.10.3.2 External Sweep.

### 3.15.9.3 RMS-Selektiv-Sweep

With the RMS selective sweep, the center frequency of a bandpass or bandstop filter is swept between the start/stop frequencies and an RMS measurement is carried out after each sweep step.

The sweep is triggered with "INIT", "\*TRG" or GET (see section 3.6.7 Triggering a Measurement/Sweep)

```

:
100 IEC OUT 20,"SENS:FUNC 'RMSS'":'        Setup for RMS selective measurement
110 IEC OUT 20,"SENS:BAND:MODE PPCT1":'    Bandwidth of bandpass filter 1%
120 IEC OUT 20,"SENS:FREQ:MODE SWE;:SENS:SWE:MODE AUTO":' Sweep setup
130 IEC OUT 20,"SENS:SWE:SPAC LOG;POIN 50":' Log. sweep with 50 points
140 IEC OUT 20,"SENS:FREQ:STAR 4000Hz;STOP 16000Hz":' Start/stop freq.
150 IEC OUT 20,"INIT:CONT OFF;*WAI":'      Triggers sweep and waits for end
160 IEC OUT 20,"DISP:TRAC:OPER CURV":'    Selects trace display
170 IEC OUT 20,"DISP:CONF AP":'          Selects analyzer panel with graphic window
180 IEC LAD 20: IEC GTL:'                Displays curve
:

```

See also section 3.15.10.3 Configuration for Maximum Sweep Speed and 3.15.10.3.3 RMS-selective Sweep.

### 3.15.10 Tuning - Setup for Maximum Measurement Speed

#### 3.15.10.1 Configuration for Maximum Measurement Speed

To obtain maximum measurement speed, all unnecessary measurements and result displays are to be avoided. This is demonstrated by way of a fast RMS measurement:

```

:
190 IEC OUT 20,"*RST;*WAI":'           Sets up RMS measurement
200 IEC OUT 20,"DISP:ANN OFF":'       Switches off result display
210 IEC OUT 20,"SENS2:FUNC 'OFF'":'   Switches off PEAK measurement
220 IEC OUT 20,"SENS3:FUNC 'OFF'":'   Switches off frequency measurement
230 IEC OUT 20,"SENS:VOLT:APER:MODE AFAS":' Selects high measurement speed
240 IEC OUT 20,"INIT:CONT OFF":'     Selects single measurement
250 IEC LAD 20: IEC GET : '           Triggers sweep with Group Execute Trigger
260 IEC OUT 20,"*WAI":' *WAI        Waits for measurement results
270 IEC OUT 20,"SENS:DATA1?":'       Selects RMS results on channel 1
280 IEC IN 20,Mwert$: '              Reads in measured value
:

```

#### 3.15.10.2 Adapting Measurement Speed to Signal Frequency

Table 3-14 Hints for matching measurement speed and signal frequency

Automatic adaptation of measurement speed to signal frequency	
IEC/IEEE-bus command	Used for
"SENSe[1]:VOLTage:APERture:MODE AFASt"	RMS and RMS selective measurements: Automatic matching of measurement time and signal frequency by taking into account the signal period. The measurement time is optimally adapted to the input signal. An algorithmic error of max. 1% may occur
"SENSe[1]:VOLTage:APERture:MODE AUTO"	RMS and RMS selective measurements: Same as AFASt but with an algorithmic error of max. 0.1%.

Fixed measurement speed	
IEC/IEEE-bus command	Used for
"SENSe[1]:VOLTage:APERTure:MODE SFAST"	RMS and RMS selective measurements: measurement time 50 ms
"SENSe[1]:VOLTage:APERTure:MODE FAST"	RMS, RMS selective and DC measurements: measurement time 200 ms
"SENSe[1]:VOLTage:APERTure:MODE SLOW"	RMS and RMS selective measurements: measurement time 1000 ms
"SENSe[1]:VOLTage:APERTure:MODE VALue" "SENSe[1]:VOLTage:APERTure xxx ms"	RMS-, RMS selective and DC measurements: measurement time freely selectable
<p>VALue is a <b>fixed integration time</b> irrespective of the signal period.</p> <p><b>RMS and RMS selective measurements:</b></p> <ul style="list-style-type: none"> <li>• If the measurement time is an integral multiple of the signal period, optimum integration and therefore a steady display is obtained.</li> <li>• If the measurement time is longer and not an integral multiple of the signal period, an integration is obtained with a beat effect in the display.</li> </ul> <p><b>DC measurements:</b></p> <p>If an AC voltage is superimposed on the DC, the measurement time as integration period has different effects with respect to the signal period of the AC voltage shows different effects:</p> <ul style="list-style-type: none"> <li>• If the measurement time is an integral multiple of the signal period, optimum integration is obtained. The AC voltage does not influence the DC measurement result and the display is steady.</li> <li>• If the measurement time is longer and not an integral multiple of the signal period, an integration is obtained with a beat effect in the display. The AC voltage has no effect on the DC measurement result.</li> <li>• If the measurement time is shorter than the signal period, the measurement result follows the signal curve. The AC voltage affects the DC measurement result.</li> </ul>	

Fixed monitor time	
IEC/IEEE-bus command	Used for
"SENSe[1]:VOLTage:INTVtime:MODE SFAST"	PEAK measurements: time 50 ms
"SENSe[1]:VOLTage:INTVtime:MODE FAST"	PEAK measurements: time 200 ms
"SENSe[1]:VOLTage:INTVtime:MODE SLOW"	PEAK measurements: time 1000 ms
"SENSe[1]:VOLTage:INTVtime:MODE FIXed"	QPK measurements: time 3000 ms
"SENSe[1]:VOLTage:INTVtime:MODE VALue" "SENSe[1]:VOLTage:INTVtime xxx ms"	PEAK and QPK measurements: time freely selectable  Generally no recommendation can be made as to the most suitable monitor time for peak values, as it depends on the input signal and on the measurement itself.

### 3.15.10.3 Configuration for Maximum Sweep Speed

#### 3.15.10.3.1 Generator Sweep

To obtain maximum sweep speed, switch off all "slowing-down" settings. Particularly the frequency measurement and settling of the low-distortion generator are very time-consuming. If permitted by the measurement, these functions should be switched off.

The following example illustrates which functions are to be switched on or off to obtain maximum sweep speed.

A typical example is a

- **single-channel linear frequency sweep** on channel 1 of
- **100 points,**
- **200 Hz to 4 kHz** and
- **RMS measurement** in
- **AUTO FAST.**

Each speed-reducing function can be switched off separately by means of a command after the \*RST command. In this case a single sweep should be triggered once with "INIT:CONT OFF;\*WAI" (program line 230) before sweeping is started to avoid the setting times of this command influencing the sweep time. The sweep performed at maximum speed is then triggered with another INIT command (program line 300).

```

:
100 IEC OUT 20, "*RST;*WAI"
110 IEC OUT 20, "INP:TYPE GEN1"
120 IEC OUT 20, "OUTP:SEL CH2"
130 IEC OUT 20, "SENS:VOLT:RANG 1V": ' Prevent ranging
140 IEC OUT 20, "SOUR:LOWD OFF": ' Low-distortion generator off
150 IEC OUT 20, "SENS:VOLT:APER:MODE GENT": ' Measurement speed GEN TRACK
160 IEC OUT 20, "SENS2:FUNC 'OFF'": ' Input peak measurement off
170 IEC OUT 20, "SENS3:FUNC 'OFF'": ' Frequency measurement off
180 IEC OUT 20, "DISP:ANN OFF": ' No display of measured values
190 IEC OUT 20, "SOUR:SWE:MODE AUTO;;SOUR:FREQ:MODE SWE1": 'Frequency sweep
200 IEC OUT 20, "SOUR:FREQ:STAR 200;STOP 4000": ' Sweep 200Hz to 4kHz
210 IEC OUT 20, "SOUR:SWE:FREQ:SPAC LIN": ' Linear sweep
220 IEC OUT 20, "SOUR:SWE:FREQ:POIN 100": ' 100 Sweep points
230 IEC OUT 20, "INIT:CONT OFF;*WAI": ' Triggers single sweep
240 IEC OUT 20, "SYST:BEEP:STAT OFF": ' Dummy command waits for sweep end
:
300 IEC OUT 20, "INIT;*WAI": ' Einzelswp mit max. Geschwindigkeit ausloesen
310 IEC OUT 20, "SYST:BEEP:STAT OFF": ' Dummy command waits for sweep end
:

```

The fastest way to set a suitable sweep is to load an ACTUAL SETUP in which the required settings have already been made.

```

:
100 IEC OUT 20, "MMEM:LOAD:STAT 0, 'C:\UPL\USER\MAXSWP.SAC';*WAI"
110 IEC OUT 20, "INIT;*WAI": ' Triggers single sweep
120 IEC OUT 20, "SYST:BEEP:STAT OFF": ' Dummy command waits for sweep end
:

```

The maximum sweep speed attained in this example is approx. 25 ms/step when an UPL with 386 board is used and approx. 8 ms/step when a 486 board is used.



### 3.15.10.3.2 External Sweep

The example below demonstrates the setup for a fast external frequency sweep with a sweep-signal sequence obtained, for instance, from a CD or tape.

#### Matching the external frequency sweep to the signal sequence:

- Set a start value which should corresponds to the expected lowest frequency of the sweep-signal sequence.
- Select a stop value slightly below the expected highest sequence frequency (approx. 0.1%) to provide a safe halt criterion.
- elect a variation that is approx. 5 to 10 % lower than the expected frequency variation of the signal sequence to ensure safe triggering and avoid unwanted intermediate values.

The example below illustrates the settings for matching the external sweep of the UPL to the signal sequence generated by a sweep generator for demonstration purposes.

Connect the sweep generator to UPL input UNBAL Ch1, and set and start a

- continuous logarithmic sweep of 100 Hz to 16.1 kHz,
- with a step width 5%,
- and 120-ms time tick

The external sweep parameters of the UPL are set as recommended above and the external single sweep is started.

- Start frequency of ext. sweep = 100 Hz (expected lowest frequency in this case 100 Hz)
- Stop frequency of ext. sweep = 16 kHz (0.1% below the expected highest frequency, in this case 16.1 kHz)
- Variation of ext. sweep = 4.5% (10% below the expected frequency variation of the sequence, in this case 5 %)

Each time the frequency varies by more than 4.5% on channel 1, UPL carries out an RMS measurement until a frequency greater than 16 kHz is measured. After this the external sweep is terminated and the sweep curve is displayed.

With the speed-increasing settings in lines 270 to 290 and the fast frequency measurement for the external sweep in line 310, a signal sequence with a **minimum time tick of 120 ms** can still be reliably measured. For all other settings a longer time is required.

```

:
260 *** Speed-increasing settings
270 IEC OUT 20,"DISP:ANN OFF": '                               Display Update off
280 IEC OUT 20,"SENS3:FUNC 'OFF'": '                           Frequency measurement off
290 IEC OUT 20,"SENS:VOLT:APER:MODE AFAS": '                   RMS meas. speed AUTO FAST
300 *** Setting of external sweep parameters
310 IEC OUT 20,"TRIG:SOUR CH1R": '                               Ext. sweep with fast freq. measurement
320 IEC OUT 20,"ARM:LEV:MIN 100 mV": '                           Measurement above 100 mV
330 IEC OUT 20,"ARM:FREQ:STAR 100 Hz": '                       Start frequency 100 Hz
340 IEC OUT 20,"ARM:FREQ:STOP 16 kHz": '                       Stop frequency 16 kHz
350 IEC OUT 20,"TRIG:FREQ:VAR 4.5": '                           Var. just below sweep step width
360 IEC OUT 20,"DISP:CONF AP": '                               Selects graphic window
370 PRINT "External sweep is started - recording goes on!"
380 IEC OUT 20,"INIT:CONT OFF;*WAI": '                         Triggers external single sweep
390 IEC OUT 20,"SYST:BEEP:STAT ON": '                           Dummy command waits for sweep end
400 IEC LAD 20: IEC GTL : '                                       Displays curve
:

```

### 3.15.10.3.3 RMS Selective Sweep

In the example below settings are made for a fast RMS selective sweep. The sweep speed mainly depends on the

- bandwidth of the set bandpass /bandstop filter and the
- center frequency.

The bandpass or bandstop filters are very steep filters with an attenuation of 100 dB. The higher the center frequency the wider the passband range and the faster the settling and therefore the RMS selective measurement.

The example below illustrates a fast RMS selective sweep of a 5-kHz squarewave signal produced by the UPL generator. The narrowband RMS measurement from 4 to 16 kHz yields a spectrum display of the fundamental with the 2nd and 3rd harmonic of the squarewave signal.

```

10 IEC TERM 10: IEC TIME 60000
20 IEC OUT 20,"*RST;*WAI;:DISP:MODE COLB;:INP:TYPE GEN2"
30 IEC OUT 20,"SOUR:FUNC SQU;:SOUR:FREQ 5000Hz;:SOUR:VOLT 1V"
70 IEC OUT 20,"SENS:FUNC 'RMSS'":'          Switches on RMS selective measurement
80 '*** Speed-increasing measures
90 IEC OUT 20,"SENS:VOLT:APER:MODE AFAS":'          Fast RMS measurement
100 IEC OUT 20,"SENS2:FUNC 'OFF'":'          Input-peak measurement off
110 IEC OUT 20,"SENS3:FUNC 'OFF'":'          Frequency measurement off
120 IEC OUT 20,"DISP:ANN OFF":'          Display Update off
130 '*** Settings for RMS selective sweep
140 IEC OUT 20,"SENS:BAND:MODE PPCT1":'          Bandpass filter 1%
150 IEC OUT 20,"SENS:FREQ:MODE SWE;:SENS:SWE:MODE AUTO":'          Auto sweep
160 IEC OUT 20,"SENS:SWE:SPAC LOG;POIN 50":'          Log. sweep over 50 points
180 IEC OUT 20,"SENS:FREQ:STAR 4000Hz;STOP 16000Hz":'          Start/stop frequency
190 '*** Settings for graphics display
200 IEC OUT 20,"DISP:TRAC:OPER CURV"
210 IEC OUT 20,"DISP:TRAC:Y:UNIT DBV;:DISP:TRAC:X:AUTO OFF"
220 IEC OUT 20,"DISP:TRAC:X:LEFT 3000Hz;RIGH 17000Hz":'          X scale
230 'Measuring the sweep time
240 Z1=TIME
250 IEC OUT 20,"INIT:CONT OFF;*WAI"
260 IEC OUT 20,"DISP:CONF AP":'          Selects analyzer panel with graphic window
270 Z2=TIME: IEC LAD 20: IEC GTL:'          Displays spectrum
280 PRINT (Z2-Z1)/100;" Sec pro Sweep": END

```

Speed-increasing measures become more effective towards higher center frequencies (> 5 kHz)!

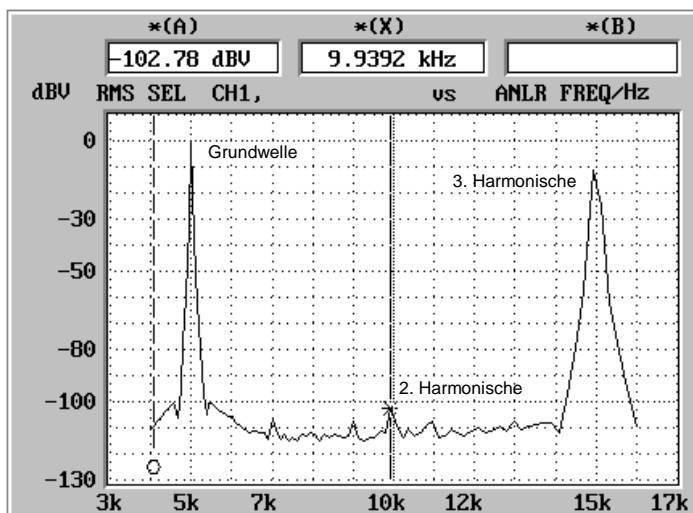

Fig. 3-9 Spectrum of 5-kHz squarewave obtained through RMS selective sweep

### 3.15.10.3.4 Measurement Speed with Reference to Sampling Mode

If the HIGH RATE sampling mode (CONF:DAI HRM) is used with option UPL-B29 (digital audio 96 kHz), the increased performance requirements caused by the higher clock rates lead to a certain reduction of the measurement speed as compared to the BASE RATE mode (CONF:DAI BRM). See also chapter 2.6.8 **Optimizing the Measurement Speed**, section 5, Optimized Utilization of DSP Performance with Reference to the Clock Rate.

## 3.15.11 List Management

### 3.15.11.1 Loading Lists into the UPL

#### 3.15.11.1.1 Loading Sweep Lists into the UPL

Depending on the application, data are loaded into the UPL by a variety of commands that can be looked up in section 3.10.6 Commands for Graphical Representation of Results. Loading the frequency values for a frequency sweep is used as an example for demonstrating the procedure.

Load command:

```
"SOURCE:LIST:FREQUENCY 100.0,300.0,500.0, ... ,20000"
```

permits a maximum of 1024 values to be loaded.

Use DATA and READ for handling a greater number of frequency values in program code:

```
:
8110 DATA 100,300,500,700,800,900,1000,2000,3000,4000,5000,6000,7000
8120 DATA 10000,13000,15000,17000,20000,0
8150 IEC OUT 20,"SOUR:SWE:MODE AUTO":' AUTO sweep
8160 IEC OUT 20,"SOUR:FREQ:MODE LIST1":' LIST sweep of frequencies
8170 Bef$="SOURCE:LIST:FREQ":' Lists block data of frequencies
8180 READ Frq
8190 Loop1:
8200 IF Frq<>0 THEN Bef$=Bef$+STR$(Frq)
8210 READ Frq: IF Frq<>0 THEN Bef$=Bef$+",": GOTO Loop1
8230 IEC OUT 20,Bef$: ' Outputs block command
:
```

#### 3.15.11.1.2 Loading and Display of Several Traces in the UPL

Not only curves generated in the UPL by a sweep or FFT, or those stored in a file can be graphically displayed but also any data sequences loaded into the UPL by the control program. All UPL capabilities for scaling and unit conversion are used for the graphic display.

The following routine demonstrates loading of three traces into the UPL and their graphic display.

```
:
200 '***** Loading traces *****
210 IEC OUT 20,"DISP:TRAC:COUN 3":' Sets number of traces to be loaded
220 IEC OUT 20,"DISP:TRAC:IND 0":' Selects trace with index 0
230 IEC OUT 20,"TRAC LIST1, 100,1000,5000,15000":' X values for trace 0
240 IEC OUT 20,"TRAC TRAC1, 0.001,0.01,0.01,0.001": 'Y values for trace 0
250 IEC OUT 20,"DISP:TRAC:IND 1":' Selects trace with index 1
260 IEC OUT 20,"TRAC LIST1, 100,1500,5500,15000":' X values for trace 1
270 IEC OUT 20,"TRAC TRAC1, 0.001,0.02,0.02,0.001": 'Y values for trace 1
280 IEC OUT 20,"DISP:TRAC:IND 2":' Selects trace with index 2
290 IEC OUT 20,"TRAC LIST1, 100,1800,6000,15200":' X values for trace 2
300 IEC OUT 20,"TRAC TRAC1, 0.001,0.03,0.03,0.001": 'Y values for trace 2
310 IEC OUT 20,"DISP:TRAC:OPER CURV":' Selects the display mode
320 IEC OUT 20,"DISP:TRAC:Y:AUTO ONCE":' Optimizes scale
```

```

330 IEC OUT 20,"DISP:CONF AP":'      Activates analyzer panel + graphic window
340 IEC LAD 20:IEC GTL:'              Displays curve
:
```

**Note:**

*If traces are loaded into the UPL under program control and a sweep is subsequently selected, the trace in the display will be erased and the sweep curve displayed.*

**3.15.11.1.3 Loading and Displaying of Trace Pairs in the UPL**

The program below demonstrates loading of three trace pairs into the UPL, the graphic display, subsequent selection of another unit, rescaling and changing from linear to logarithmic display on the X axis.

```

:
```

```

290 IEC OUT 20,"DISP:TRAC1:FEED 'SENS:DATA'":'      Enables trace A
300 IEC OUT 20,"DISP:TRAC2:FEED 'SENS:DATA'":'      Enables trace B
310 IEC OUT 20,"DISP:TRAC:COUN 3":'Three trace pairs
320 IEC OUT 20,"DISP:TRAC:IND 0":'                  Selects trace pair with index 0
330 IEC OUT 20,"TRAC LIST1, 100,1000,5000,15000":'  X values of trace A
340 IEC OUT 20,"TRAC TRAC1, 0.001,0.01,0.01,0.001":' Y values of trace A
350 IEC OUT 20,"TRAC LIST2, 100,1100,5100,15000":'  X values of trace B
360 IEC OUT 20,"TRAC TRAC2, 0.001,0.02,0.02,0.001":' Y values of trace B
370 IEC OUT 20,"DISP:TRAC:IND 1":'                  Selects trace pair with index 1
380 IEC OUT 20,"TRAC LIST1, 100,1500,5500,15000":'  X values of trace A
390 IEC OUT 20,"TRAC TRAC1, 0.001,0.03,0.03,0.001":' Y values of trace A
400 IEC OUT 20,"TRAC LIST2, 100,1600,5600,15000":'  X values of trace B
410 IEC OUT 20,"TRAC TRAC2, 0.001,0.04,0.04,0.001":' Y values of trace B
420 IEC OUT 20,"DISP:TRAC:IND 2":'                  Selects trace pair with index 2
430 IEC OUT 20,"TRAC LIST1, 100,1800,6000,15200":'  X values of trace A
440 IEC OUT 20,"TRAC TRAC1, 0.001,0.05,0.05,0.001":' Y values of trace A
450 IEC OUT 20,"TRAC LIST2, 100,1900,6100,15200":'  X values of trace B
460 IEC OUT 20,"TRAC TRAC2, 0.001,0.06,0.06,0.001":' Y values of trace B
470 IEC OUT 20,"DISP:TRAC:OPER CURV":'              Selects trace display
480 IEC OUT 20,"DISP:TRAC2:Y:EQU ON":'              Scaling of trace B same as for A
490 IEC OUT 20,"DISP:TRAC1:Y:AUTO ONCE":'           Autoscaling
500 IEC OUT 20,"DISP:CONF DP":'                      Selects DISPLAY panel with graphic window
510 IEC LAD 20: IEC GTL: HOLD 5000:'                 Result display for 5 s
520 IEC OUT 20,"DISP:TRAC1:Y:UNIT W":'              Conversion of Y values into Watt
530 IEC OUT 20,"DISP:TRAC1:Y:AUTO ONCE":'           Autoscaling
540 IEC LAD 20: IEC GTL:HOLD 5000:'                 Result display for 5 s
550 IEC OUT 20,"DISP:TRAC:X:SPAC LOG":'             Log display on X scale
560 IEC OUT 20,"DISP:TRAC1:Y:AUTO ONCE":'           Autoscaling
570 IEC LAD 20: IEC GTL
:
```

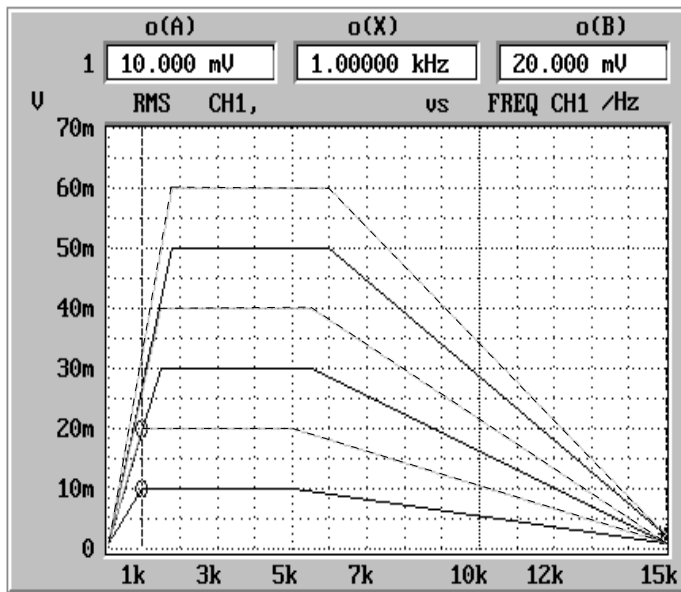

Fig. 3-10 Trace pairs loaded into UPL by control program

### 3.15.11.2 Readout of Data Lists from the UPL

When data lists are read from the UPL, in compliance with SCPI values are always transferred in the basic unit even if other units have been selected for the trace display. The table below shows the basic units for transferring data of various functions from the UPL to the controller.

Table 3-15 Basic units of data

Measurement function/sweep settings	Data with basic unit for analog/digital instruments
"SENS:FUNC 'RMS' "	V/FS
"SENS:FUNC 'RMSS' "	V/FS
"SENS:FUNC 'PEAK' "	V/FS
"SENS:FUNC 'QPE' "	V/FS
"SENS:FUNC 'DC' "	V/FS
"SENS:FUNC 'THD' "	%
"SENS:FUNC 'THDN' "	%
"SENS:FUNC:MMOD THDN NOIS	%
"SENS:FUNC:MMOD SNDR	% (große Werte)
"SENS:FUNC:MMOD LTHD LNOI	V/FS
"SENS:FUNC 'DFD' "	%
"SENS:FUNC 'DIM' "	%
"SENS:FUNC 'MDIS' "	%
"SENS:FUNC 'WAF' "	%
"SENS:FUNC 'POL' "	keine Daten
"SENS:FUNC 'FFT' "	V/FS
"SENS:FUNC 'WAV' "	V/FS
"SENS:FUNC 'COHE' "	%
"SENS:FUNC 'RUBB' "	V
"SENS2:FUNC 'PEAK' "	V/FS
"SENS2:FUNC 'RMS' "	V/FS

"SENSe2:FUNcTion 'DIGInpamp' "	V
"SENSe2:FUNcTion 'PHASetoref' "	UI
"SENS3:FUNC 'FREQ' "	Hz
"SENS3:FUNC 'FQPH' "	Grad
"SENS3:FUNC 'FQGR' "	s
"SOUR:FREQ:MODE ..."	Hz
"SOUR:VOLT:MODE ..."	V/FS
"SOUR:ONT:MODE ..."	s
"SOUR:INT:MODE ..."	s
"SENS:FREQ:MODE ..."	Hz

When reading out lists remember that with commands

- "SOUR:LIST:FREQ?"
- "SOUR:LIST:INT?"
- "SOUR:LIST:ONT?"
- "SOUR:LIST:VOLT?"
- "SENS:LIST:FREQ?"

always the X values of the set sweep are read, contrary to commands

- "TRAC? LIST1"
- "TRAC? LIST2"

which cause the X values of the current graphic display to be read.

**Note:**

Normally, X values are identical for both command groups. They are only different if **other than the sweep curve is subsequently** selected by means of program control or by loading a file while the sweep mode is on .

### 3.15.11.2.1 Readout of Lists of up to 1024 Values

A great number of application-specific commands are available for reading out sweep data, FFT data, data loaded from a file or by the control program (see section 3.10.6 Commands for Graphical Representation of Results). The procedure is illustrated by an example for reading out level values of a frequency sweep.

The readout procedure is as follows

```
"TRAC? TRAC" permits 1024 values to be read.
:
8270 IEC OUT 20,"INIT:CONT OFF;*WAI": '           Triggers a single sweep
:
8420 IEC OUT 20,"TRAC? TRAC": '           Reads in level data of trace A
8430 IEC IN 20,S$: '           S$ comprises an ASCII string with level values in the
8440 '           form "1.1234E-003,2.3456E-002,3.4567E-001 ..."
:
```

### 3.15.11.2.2 Readout of FFT Lists of more than 1024 Values

The number of values that can be transferred is limited to 1024 lines. If more than 1024 lines are to be read, the data have to be divided in blocks of 1024 values. The table in section 2.6.5.12 FFT informs on the number of lines of the selected FFT which are a function of FFT size and zooming.

In the R&S BASIC program below, the 7488 lines of a 8k-zoom FFT with 8 blocks each (7 x 1024 and 1 x 320 lines) are read and stored in the form of a string (eg "5.50884e-004,4.1273e-004,1.64638e-004,...") in files FFT\_Y1.TXT ... FFT\_Y8.TXT.

:

```
500 FOR Blkidx=0 TO 7
510 IEC OUT 20,"DISP:TRAC:IND"+STR$(Blkidx):'   Selects block index 0 to 7
520 '                                           Reads out FFT lines and stores in string Fftdat$
530 IEC OUT 20,"TRAC? TRAC"
540 IEC IN 20,Fftdat$: '                       Reads in FFT data as ASCII string
550 Filename$="FFT_Y"+RIGHT$(STR$(Blkidx+1),1)+".TXT":'   Defines file name
560 OPENO# 1,Filename$: PRINT# 1,Fftdat$: CLOSE# 1
570 NEXT Blkidx
      :
```

FFT line frequencies are read out in the same way with command  
"TRAC? LIST1"

### 3.15.11.2.3 FFT Lists with Suppressed Noise Floor

Since in most cases the noise floor of an FFT is of no interest, the number of lines can be considerably reduced by including only values exceeding a certain limit in the trace, eg 0.1 V.

To do so set the UPL as described below:

```

:
100 IECOUT 20,"DISPlay:TRACe:OPERation FFTErrors":'           Sets limits
110 IECOUT 20,"CALCulate:LIMit:UPPer:VALue 0.1V":'..         >0.1 V
:
510 IEC OUT 20,"DISP:TRAC:IND 0":'                             Block index 0
520 IEC OUT 20,"TRAC? TRAC":'                                 Stores FFT lines above 0.1 V
530 IEC IN 20,Fftdat$: '                                     as string data under Fftdat$
:

```

FFT lines frequencies are read out in the same way using command  
"TRAC? LIST1"

### 3.15.11.2.4 Readout of Several Traces from UPL

If several traces are displayed on the UPL ("DISP:TRAC:COUN > 1" set), the required trace can be selected with command "DISP:TRAC:IND 0 to 17" and read out with commands "TRAC? LIST1" and "TRACE? TRAC":

```

:
200 '***** Readout of traces *****'
220 IEC OUT 20,"DISP:TRAC:IND 0":'                               Selects trace with index 0
230 IEC OUT 20,"TRAC? LIST1":'                                   Selects X values of trace with index 0
240 IEC IN 20,X0$: '                                           Stores X values as ASCII string under X0$
250 IEC OUT 20,"TRAC? TRAC":'                                   Selects Y values of trace with index 0
260 IEC IN 20,Y0$: '                                           Stores Y values as ASCII string under Y0
270 IEC OUT 20,"DISP:TRAC:IND 1":'                               Selects trace with index 1
280 IEC OUT 20,"TRAC? LIST1":'                                   Selects X values of trace with index 1
290 IEC IN 20,X1$: '                                           Stores X values as ASCII string under X1$
300 IEC OUT 20,"TRAC? TRAC":'                                   Selects Y values of trace with index 1
310 IEC IN 20,Y1$: '                                           Stores Y values as ASCII string under Y1$
320 IEC OUT 20,"DISP:TRAC:IND 2":'                               Selects trace with index 2
330 IEC OUT 20,"TRAC? LIST1":'                                   Selects X values of trace with index 2
340 IEC IN 20,X2$: '                                           Stores X values as ASCII string under X1$
350 IEC OUT 20,"TRAC? TRAC":'                                   Selects Y values of trace with index 2
:

```



## 3.15.11.2.5 Readout of Trace Pairs from UPL

Trace pairs are read out in the way described in section 3.15.11.2.4 Readout of Several Traces from UPL, with the difference

"TRAC? LIST1" and "TRAC? TRAC1" reads out the X and Y values of trace A

"TRAC? LIST2" and "TRAC? TRAC2" reads out the X and Y values of trace B

```

:
200 '***** Readout of trace pairs*****'
220 IEC OUT 20,"DISP:TRAC:IND 0":'          Selects trace pair with index 0
230 IEC OUT 20,"TRAC? LIST1":'           Selects X values of trace A with index 0
240 IEC IN 20,Xa0$: '                     Stores X values as ASCII string under Xa0$
250 IEC OUT 20,"TRAC? TRAC1":'          Selects Y values of trace A with index 0
260 IEC IN 20,Ya0$: '                     Stores Y values as ASCII string under Ya0$
270 IEC OUT 20,"TRAC? LIST2":'          Selects X values of trace B with index 0
280 IEC IN 20,Xb0$: '                     Stores X values as ASCII string under Xb0$
290 IEC OUT 20,"TRAC? TRAC2":'          Selects Y values of trace B with index 0
300 IEC IN 20,Yb0$: '                     Stores Y values as ASCII string under Yb0$
310 '
320 IEC OUT 20,"DISP:TRAC:IND 1":'        Selects trace pair with index 1
330 IEC OUT 20,"TRAC? LIST1":'           Selects X values of trace A with index 1
340 IEC IN 20,Xa1$: '                     Stores X values as ASCII string under Xa0$
350 IEC OUT 20,"TRAC? TRAC1":'          Selects Y values of trace A with index 1
360 IEC IN 20,Ya1$: '                     Stores Y values as ASCII string under Ya0$
370 IEC OUT 20,"TRAC? LIST2":'          Selects X values of trace B with index 1
380 IEC IN 20,Xb1$: '                     Stores X values as ASCII string under Xb0$
390 IEC OUT 20,"TRAC? TRAC2":'          Selects Y values of trace B with index 1
400 IEC IN 20,Yb1$: '                     Stores Y values as ASCII string under Yb0$
410 '
420 IEC OUT 20,"DISP:TRAC:IND 2":'        Selects trace pair with index 2
430 IEC OUT 20,"TRAC? LIST1":'           Selects X values of trace A with index 2
440 IEC IN 20,Xa2$: '                     Stores X values as ASCII string under Xa0$
450 IEC OUT 20,"TRAC? TRAC1":'          Selects Y values of trace A with index 2
460 IEC IN 20,Ya2$: '                     Stores Y values as ASCII string under Xa0$
470 IEC OUT 20,"TRAC? LIST2":'          Selects X values of trace B with index 2
480 IEC IN 20,Xb2$: '                     Stores X values as ASCII string under Xa0$
490 IEC OUT 20,"TRAC? TRAC2":'          Selects Y values of trace B with index 2
500 IEC IN 20,Yb2$: '                     Stores Y values as ASCII string under Xa2$
:

```

### 3.15.12 Filter Settings

In the case of RMS measurements, the analyzer permits a maximum of 4 filters to be switched into the measurement path, 3 filters with PEAK and QPK measurements and one filter with THDN measurements. Fixed filters like CCITT, CCIR or WRUMble or user-defined filters can be used.

The example below illustrates a customized filters made up of a bandpass filter of 11 to 15 kHz and the two notch filters of 12 and 14 kHz.

```

:
300 IEC OUT 20,"*RST;*WAI":'                               *WAI waits for end of calibration
310 IEC OUT 20,"DISP:MODE COLB":'                           Coloured user interface
315 '----- User filter No. 1: Bandpass filter 11 to 15 kHz, Atten. 100 dB
320 IEC OUT 20,"SENS:UFIL1:BPAS ON"
330 IEC OUT 20,"SENS:UFIL1:PASS:LOW 11 KHZ"
340 IEC OUT 20,"SENS:UFIL1:PASS:UPP 15 KHZ"
350 IEC OUT 20,"SENS:UFIL1:ATT 100 DB"
355 '----- User filter No. 2: 12-kHz notch filter
360 IEC OUT 20,"SENS:UFIL2:NOTC ON"
370 IEC OUT 20,"SENS:UFIL2:CENT 12 KHZ"
380 IEC OUT 20,"SENS:UFIL2:WIDT 500 HZ"
390 IEC OUT 20,"SENS:UFIL2:ATT 100 DB"
395 '----- User filter No. 3: 14-kHz notch filter
400 IEC OUT 20,"SENS:UFIL3:NOTC ON"
410 IEC OUT 20,"SENS:UFIL3:CENT 14 KHZ"
420 IEC OUT 20,"SENS:UFIL3:WIDT 500 HZ"
430 IEC OUT 20,"SENS:UFIL3:ATT 100 DB"
435 'The 3 customized filters defined above are used for RMS
436 'measurements; the bandpass filter for increasing the filter slope
437 'is used twice.
440 IEC OUT 20,"SENS:FUNC 'RMS'"
450 IEC OUT 20,"SENS:FILT1:UFIL1 ON":'
460 IEC OUT 20,"SENS:FILT2:UFIL1 ON":'
470 IEC OUT 20,"SENS:FILT3:UFIL2 ON":'
480 IEC OUT 20,"SENS:FILT4:UFIL3 ON":'
:

```

Two bandpass filters for  
increasing the filter slope  
12-kHz notch filter  
14-kHz notch filter

Filter curve obtained in a sweep from 9 to 17 kHz:

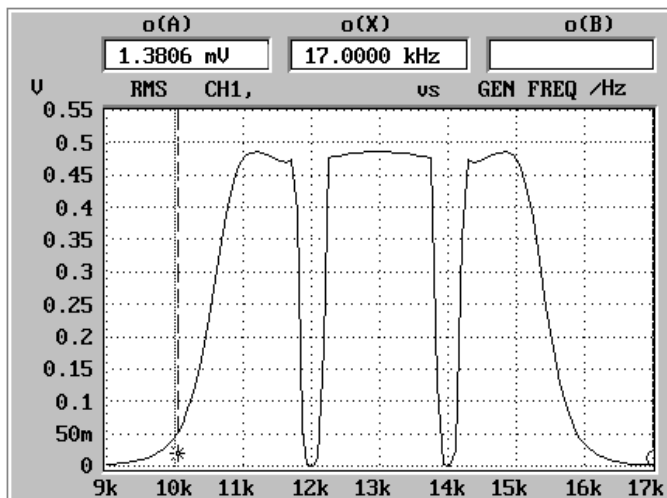

Fig. 3-11 Filter curve: steep bandpass filter + 2 notch filters

### 3.15.13 Finding a File

UPL provides no special command to find out whether a file has been stored on the UPL hard disk or on a floppy.

Remedy:

If an attempt to copy the file in a temporary file is not followed by an error message, the file already exists.

```

:
100 File$ = "'C:\UPL\USER\MY.SCO':" File of interest
110 IECOUT 20,"MMEM:COPY "+File$+", 'TMP.TMP'"
120 IECOUT 20,"SYST:ERROR?": IECIN 20,E$
130 IF LEFT$(E$,1)="0" THEN
140   PRINT "File available!"
150 ELSE
160   PRINT "File not available!"
170 ENDIF
:

```

### 3.15.14 Readout of Error Queue

The error queue can be read out after each command or by means of an SRQ interrupt routine if an error has occurred (see section 3.7.4.5 **Error Queue Query**)

The program below is a routine for reading out the error queue until it is empty.

```

:
1290Errqueue:
1300 IEC OUT 20,"SYST:ERR?": '   Reads out error queue until queue is empty
1310 IEC IN 20,E$
1320 IF LEFT$(E$,1)="0" THEN RETURN:'           Quits error routine
1330 PRINT "Contents of error queue: ";E$: GOTO Errqueue
:

```

### 3.15.15 Command Synchronization

The synchronization modes realized in the example below are described in section 3.6.8, Command Synchronization.

Use commands \*WAI, \*OPC? or \*OPC with SRQ to terminate a specific action before a new one is executed. Through suitable programming the controller can be made to wait for a specific action to be completed (see section 3.6.8.3 **Comparison of Synchronization Capabilities**).

There are two events in the UPL which have to be waited for before the next command can be executed:

- End of calibration
- End of measurement

Selection of an instrument with automatic calibration is used as an example for demonstrating the three synchronization methods. The following command should only be sent when the automatic calibration is completed. For more detailed information refer to section 3.6.8.1 **Wait for End of Calibration**.

### 3.15.15.1 Command Synchronization with \*WAI

```
IECOUT 20,"INSTRument2 A100;*WAI":'           Selects new analog instrument and
                                                waits with *WAI for end of calibration
```

### 3.15.15.2 Command Synchronization with \*OPC?

```
IECOUT 20,"INSTRument2 A100":'           Selects new analog instrument
IECOUT 20,"*OPC?":'                       Sends OPC?. Calibration is terminated when
IECIN 20,A$: '                             the response "1" is received.
```

### 3.15.15.3 Command Synchronization with \*OPC and SRQ

Command synchronization with \*OPC and SRQ is described in advance of section 3.15.16 Service Request, which should best be read through first. Waiting for end of calibration with \*OPC and SRQ after an instrument selection is again used as an example.

#### Procedure:

- set Operation Complete bit (OPC) in the Event Status Register,
- set ESB bit 5 in the Status Byte Register
- activate SRQ handler,
- call up change of instrument with automatic calibration,
- output synchronization command \*OPC,
- wait in a loop for SRQ (end of calibration).

```
1057 '***** Setting up SRQ *****
1058 IEC TERM 10:'                               Line Feed as terminator
1059 IEC TIME 10000.'                             IEC/IEEE-bus timeout 10 s
1060 IEC OUT 20,"*CLS"
1061 'Enable OPC (Operation Complete) in the Event Status Register
1062 '
1063 '
1064 '
1065 IEC OUT 20,"*ESE 1": '
1066 '
1067 'Trigger SRQ through entry in the Event Status Register (d5=1)
1068 '
1069 '
1070 '
1071 IEC OUT 20,"*SRE 96": '
1072 '
1073 ON SRQ1 GOSUB Srqintr:'   Activate SRQ handler of IEC/IEEE bus No. 1
:
1080 IECOUT 20,"INSTRument2 A100":' Instrument change with autom. calibr.
1090 IECOUT 20,"*OPC":'       Synchronization command
:
1100 REPEAT
1110 'Other tasks may be performed as long as no SRQ is appears.
1120 'Signalled by a count on screen.
1130 Count=Count+1: PRINT Count
1140 UNTIL Srqflag=0:'       Flag = 1 when calibration is completed
:
2000 '** Standard SRQ interrupt routine shown in section 4.15.1.2 **
2010 Srqintr:
2020 IEC SPL 20,Sb%: '       Reads in Status Byte via Serial Poll
2040 :
```

### 3.15.16 Service Request

As can be seen from the introduction to the SRQ standard routine below, a Service Request routine requires an extended initialization of the UPL.

The SRQ standard routine uses Serial Poll for processing SRQ . This SRQ routine is used in almost all demo programs but for the sake of clarity it is not listed each time (remark in program code). The program example in section 3.15.16.2 SRQ Interrupt Routine with Parallel Poll, demonstrates SRQ handling by means of Parallel Poll which should be used to speed up identification of the instrument raising the SRQ when several IEC/IEEE-bus instruments are connected.

Same as with all other program examples it is assumed that IEC/IEEE-bus address 20 is set on the UPL to be controlled.

#### 3.15.16.1 SRQ Interrupt Routine with Serial Poll

The examples below for initializing an SRQ and the SRQ interrupt routine are suggestions which can be modified as required by the specific application.

Serial Poll SRQ and the Serial Poll SRQ interrupt routine are initialized in this or a similar form in almost all program examples.

##### 3.15.16.1.1 Initialization of Serial Poll SRQ

```

:
100 '***** Initializing Serial Poll SRQ *****
110 IEC TERM 10:' IEC/IEEE-bus terminator = Line Feed
120 IEC TIME 10000: ' IEC/IEEE-bus waiting time 10 s
130 IEC OUT 20,"*CLS":'Resets Status Register
140 'Enables error bits in the Event Status Register
150 '
160 '
170 '
180 IEC OUT 20,"*ESE 61": '
190 '
200 'Enables d5 for SRQ trigger through Event Status Register
210 '
220 '
230 '
240 IEC OUT 20,"*SRE 96": '
250 '
260 Srqflag=0
270 ON SRQ1 GOSUB Srqintr: ' Activates SRQ handler
:

```

Event Status Register							
d7	POW	USR	CME	EXE	DDE	QUE	d0
	0	0	1	1	1	1	0

Status Byte Register						
d7	SOR	RQS	ESB	SQR		d0
	0	1	1	0	0	0

### 3.15.16.1.2 Serial Poll SRQ Routine

The following standard SRQ interrupt routine is used in almost all the program examples. It displays the reason for the SRQ and the contents of the error queue on the controller monitor and signals to the main program with `Srqflag = 1`, that a SRQ has occurred.

```

1000Srqrintr:
1010 ' *****
1020 ' ***** Standard SRQ Interrupt Routine *****
1030 ' *****
1040 IEC SPL 20,Sb%: ' Read-in of Status Byte
1050 IF (Sb% AND 64)=0 THEN GOTO Ret: ' No response in the case of false
alarm
1060 Srqflag=1
1070 PRINT "Status Byte Register = ";Sb%
1080 IF (Sb% AND 1) THEN PRINT " SRQ->Not used"
1090 IF (Sb% AND 2) THEN PRINT " SRQ->Not used"
1100 IF (Sb% AND 4) THEN PRINT " SRQ->Not used"
1110 IF (Sb% AND 8) THEN PRINT " SRQ->Questionable-status bit"
1120 IF (Sb% AND 16) THEN PRINT " SRQ->Not used"
1130 IF (Sb% AND 32) THEN PRINT " SRQ->Event-status bit"
1140 IF (Sb% AND 64) THEN PRINT " SRQ->Summary bit"
1150 IF (Sb% AND 128) THEN PRINT " SRQ->Operation-status bit"
1160 '
1170 IEC OUT 20,"*ESR?": ' Read-in of Status Register
1180 IEC IN 20,Es$
1190 PRINT "Event Status Register = ";Es$
1200 IF (VAL(Es$) AND 1) THEN PRINT " ESR->Operation-complete bit"
1210 IF (VAL(Es$) AND 2) THEN PRINT " ESR->Not used"
1220 IF (VAL(Es$) AND 4) THEN PRINT " ESR->Query-error bit"
1230 IF (VAL(Es$) AND 8) THEN PRINT " ESR->Device-dep. error bit"
1240 IF (VAL(Es$) AND 16) THEN PRINT " ESR->Execution-error bit"
1250 IF (VAL(Es$) AND 32) THEN PRINT " ESR->Command-error bit"
1260 IF (VAL(Es$) AND 64) THEN PRINT " ESR->User-request bit"
1270 IF (VAL(Es$) AND 128) THEN PRINT " ESR->Power-on bit"
1280 '
1290Errqueue:
1300 IEC OUT 20,"SYST:ERR?": ' Readout of error queue until queue is empty!
1310 IEC IN 20,E$
1320 IF LEFT$(E$,1)="0" THEN GOTO Ret
1330 PRINT "Contents of Error Queue:"
1340 PRINT " ";E$: GOTO Errqueue
1350 '
1360Ret: ON SRQ1 GOSUB Srqrintr: RETURN:' Reactivates SRQ!

```

### 3.15.16.2 SRQ Interrupt Routine with Parallel Poll

#### 3.15.16.2.1 Initialization of Parallel Poll SRQ

```

:
100 '***** Initialization of Parallel Poll SRQ *****
110 IEC TERM 10: ' IEC/IEEE-bus terminator = Line Feed
120 IEC TIME 10000: ' IEC/IEEE-bus waiting time 10 s
130 IEC OUT 20,"*CLS": ' Resets Status Register
140 IEC OUT 20,"*ESE 121": ' Enables OPC,DDE,EXE,CMD in the Event Status Reg.
150 IEC OUT 20,"*SRE 32": ' Enables Event Status bit as SRQ event
160 IEC OUT 20,"*PRE 255": ' Enables all Parallel Poll lines
170 IEC PCON 20,1,6: 'UPL identifies itself with 1 on line 6
180 IEC PCON 10,1,3: 'Device with address 10 ident. itself with 1 on line 3
190 ON SRQ1 GOSUB Srqintr: ' SRQ handler activated
:

```

#### 3.15.16.2.2 Parallel Poll SRQ Routine

```

740 '*****
750 '***** Standard Parallel-Poll SRQ Interrupt Routine *****
760 '*****
770Srqintr:
790 PRINT "SRQ has occurred!"
800 IEC PPL Pp%
810 IF (Pp% AND 32)<>0 THEN GOSUB UPLsrq
820 IF (Pp% AND 4)<>0 THEN GOSUB Adr10srq
825 ON SRQ1 GOSUB Srqintr: RETURN: ' Reactivates SRQ
826 '
830UPLsrq:
840 '*****
850 '***** SRQ sent by UPL *****
860 '*****
1040 IEC SPL 20,Sb%: ' Read-in of Status Byte
1060 Srqflag=1
1070 PRINT "Status Byte Register = ";Sb%
1080 IF (Sb% AND 1) THEN PRINT " SRQ->Not used"
1090 IF (Sb% AND 2) THEN PRINT " SRQ->Not used"
1100 IF (Sb% AND 4) THEN PRINT " SRQ->Not used"
1110 IF (Sb% AND 8) THEN PRINT " SRQ->Questionable status"
1120 IF (Sb% AND 16) THEN PRINT " SRQ->Not used"
1130 IF (Sb% AND 32) THEN PRINT " SRQ->Event Status"
1140 IF (Sb% AND 64) THEN PRINT " SRQ->Summary"
1150 IF (Sb% AND 128) THEN PRINT " SRQ->Operation Status"
1160 '

```

```

1170 IEC OUT 20,"*ESR?": ' Read-in of Event Status Register
1180 IEC IN 20,Es$
1190 PRINT "Event Status Register = ";Es$
1200 IF (VAL(Es$) AND 1) THEN PRINT " ESR->Operation complete"
1210 IF (VAL(Es$) AND 2) THEN PRINT " ESR->Not used"
1220 IF (VAL(Es$) AND 4) THEN PRINT " ESR->Query error"
1230 IF (VAL(Es$) AND 8) THEN PRINT " ESR->Device-dep. error"
1240 IF (VAL(Es$) AND 16) THEN PRINT " ESR->Execution error"
1250 IF (VAL(Es$) AND 32) THEN PRINT " ESR->Command error"
1260 IF (VAL(Es$) AND 64) THEN PRINT " ESR->User request"
1270 IF (VAL(Es$) AND 128) THEN PRINT " ESR->Power on"
1280 '
1290Errqueue:
1300 IEC OUT 20,"SYST:ERR?": ' Read-out of error queue until it is empty
1310 IEC IN 20,E$
1320 IF LEFT$(E$,1)="0" THEN RETURN
1330 PRINT "Contents of error queue:"
1340 PRINT " ";E$: GOTO Errqueue
1250 RETURN
1260 '
1270Adr10srq:
1280 '*****
1290 '***** SRQ sent by device with the address 10 *****
1300 '*****
1310 IEC SPL 10,Sb%: ' Reset SRQ conditions for device with address 10
1320 'SRQ evaluation for device with the address 10
1330 '
1340 '
1350 RETURN

```

### 3.15.17 Readout of Cursor Position and Values

The values of a curve displayed on the UPL can be read by the controller, no matter whether the curve has been generated by a sweep or FFT or loaded into the UPL from a file or the controller. To do so the o- or \* cursor has to be positioned as required. The value at the cursor crossing the curve or the difference value can be read out.

The great number of commands available for positioning the cursor are listed below.

To simplify the program examples for the various cursor display modes and the respective intercept points, the cursor position is indicated directly in the form of a value.



Table 3-16 Positioning the cursor on the displayed curve

Positioning the cursor for curve display	
Positioning the o cursor:	Positioning the *-cursor:
<p><b>"DISP:TRAC:CURS1:POS:MODE MIN1"</b> Sets the horizontal o-cursor to the minimum value of <b>curve A</b> on the X axis.</p>	<p><b>"DISP:TRAC:CURS2:POS:MODE MIN1"</b> Sets the horizontal *-cursor for modes "DISP:TRAC:CURS2:POS:MODE N12 D12 C12" to the minimum value of <b>curve A</b> on the X axis .</p> <p>Sets vertical *-cursor for modes "DISP:TRAC:CURS2:POS:MODE HL1 HL2 HLD1 HLD2" to minimum of <b>curve A</b> on the Y axis.</p>
<p><b>"DISP:TRAC:CURS1:POS:MODE MAX1"</b> Sets horizontal o-cursor to maximum of <b>curve A</b>.</p>	<p><b>"DISP:TRAC:CURS2:POS:MODE MAX1"</b> Sets horizontal *-cursor for modes ⌚ "DISP:TRAC:CURS2:POS:MODE N12 D12 C12" to maximum of <b>curve A</b> on the X axis.</p> <p>Sets vertical *-cursor for modes "DISP:TRAC:CURS2:POS:MODE HL1 HL2 HLD1 HLD2" to maximum of <b>curve A</b> on the Y axis.</p>
<p><b>"DISP:TRAC:CURS1:POS:MODE MIN2"</b> Sets horizontal o-cursor to minimum of <b>curve B</b>.</p>	<p><b>"DISP:TRAC:CURS2:POS:MODE MIN2"</b> Sets horizontal *-cursor for modes "DISP:TRAC:CURS2:POS:MODE N12 D12 C12" to maximum of <b>curve B</b> on the X axis.</p> <p>Sets vertical *-cursor for modes "DISP:TRAC:CURS2:POS:MODE HL1 HL2 HLD1 HLD2" to minimum of <b>curve B</b> on the Y axis.</p>
<p><b>"DISP:TRAC:CURS1:POS:MODE MAX2"</b> Sets horizontal o-cursor to maximum of <b>curve B</b>.</p>	<p><b>"DISP:TRAC:CURS2:POS:MODE MAX2"</b> Sets horizontal *-cursor for modes "DISP:TRAC:CURS2:POS:MODE N12 D12 C12" to maximum of <b>curve B</b> on the X axis.</p> <p>Sets vertical *-cursor for modes ⌚ "DISP:TRAC:CURS2:POS:MODE HL1 HL2 HLD1 HLD2" to maximum of <b>curve B</b> on the Y axis.</p>
<p><b>"DISP:TRAC:CURS1:POS:MODE VALue"</b> <b>"DISP:TRAC:CURS1:POS 1000kHz"</b> Sets horizontal o-cursor for modes "DISP:TRAC:CURS1:POS:MODE N12 D12 C12" to specified position on the X axis.</p>	<p><b>"DISP:TRAC:CURS2:POS:MODE VALue"</b> <b>"DISP:TRAC:CURS2:POS 1000kHz"</b> Sets horizontal *-cursor for modes "DISP:TRAC:CURS1:POS:MODE N12 D12 C12" to specified X position.</p> <p>Sets vertical *-cursor for modes ⌚ "DISP:TRAC:CURS2:POS:MODE HL1 HL2 HLD1 HLD2" to specified position on the Y axis.</p>

Table 3-17 Positioning the cursor for FFT spectrum display

Positioning the cursor for FFT spectrum display	
Positioning the o-cursor:	Positioning the *-cursor:
"DISP:TRAC:CURS1:POS:MODE MARKer1" Sets vertical o-cursor to <b>X position</b> of marker if the latter was switched on with "DISP:TRAC1 2:MARK:MODE MAX CURS".	"DISP:TRAC:CURS2:POS:MODE MARKer1" Sets vertical *-cursor to <b>X position</b> of marker if the latter was switched on with "DISP:TRAC1 2:MARK:MODE MAX CURS".
"DISP:TRAC:CURS1:POS:MODE NEXTmarker" Sets vertical o-cursor to <b>X position</b> of next harmonic if harmonics display was switched on with DISP:TRAC1 2:MARK:HARM ON.	"DISP:TRAC:CURS2:POS:MODE NEXTmarker" Sets vertical *-cursor to <b>X position</b> of next harmonic if harmonics display was switched on with "DISP:TRAC1 2:MARK:HARM ON".
"DISP:TRAC:CURS1:POS:MODE IMAX1" Sets vertical o-cursor to <b>X position</b> of highest Y value of <b>FFT curve A</b> .	"DISP:TRAC:CURS2:POS:MODE IMAX1" Sets vertical *-cursor to <b>X position</b> of highest Y value of <b>FFT curve A</b> .
"DISP:TRAC:CURS1:POS:MODE IMAX2" Sets vertical o-cursor to <b>X position</b> of highest Y value of <b>FFT curve B</b> .	"DISP:TRAC:CURS2:POS:MODE IMAX2" Sets vertical *-cursor to <b>X position</b> of highest Y value of <b>FFT curve B</b> .

**Note:**

Positioning of \*-cursor partly depends on the set cursor mode "DISP:TRAC:CURS2:POS:MODE N12|D12|C12|HL1|HL2|HLD1|HLD2". Function and effect of the individual cursor modes can be seen from the following diagrams and the associated program line 110

**Abbreviations used in the diagrams below:**

- o(A) = Y value at crosspoint of vertical o-cursor on curve A
- o(B) = Y value at crosspoint of vertical o-cursor on curve B
- o(X) = X value of vertical o-cursor
- \*(A) = Y value at crosspoint of vertical \*-cursor on curve A
- \*(B) = Y value at crosspoint of vertical \*-cursor on curve B
- \*(X) = X value of vertical \*-cursor
- \*(Y) = Y value of horizontal \*-cursor
- \*(X)AL = X value at left crosspoint of horizontal \*-cursor on curve A
- \*(X)AR = X value at right crosspoint of horizontal \*-cursor on curve A
- \*(X)BL = X value at left crosspoint of horizontal \*-cursor on curve B
- \*(X)BR = X value at right crosspoint of horizontal \*-cursor on curve B

Cursor data for traces can be read out without restrictions as from UPL program version 2.10 onwards.!

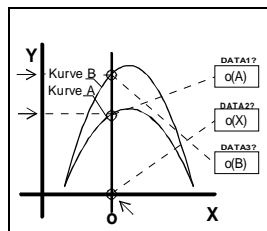

```

100 IEC OUT 20,"DISP:TRAC:CURS1 ACT": ' Activates o-cursor 1
110 IEC OUT 20,"DISP:TRAC:CURS1:MODE N12"
120 IEC OUT 20,"DISP:TRAC:CURS1:POS:MODE VAL": 'at 1000 Hz
130 IEC OUT 20,"DISP:TRAC:CURS1:POS 1000 Hz"

```

Analogously, **CURS2** activates the **\*-cursor** yielding the values **\*(A)**, **\*(X)** and **\*(B)**

Fig. 3-12 Cursor data o(A), o(X), o(B), \*(A), \*(X), \*(B)

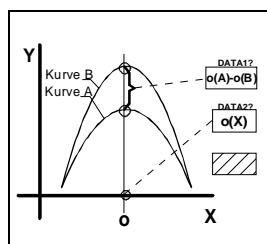

```

100 IEC OUT 20,"DISP:TRAC:CURS1 ACT": ' Activates o-cursor 1
110 IEC OUT 20,"DISP:TRAC:CURS1:MODE D12"
120 IEC OUT 20,"DISP:TRAC:CURS1:POS:MODE VAL": 'at 1000 Hz
130 IEC OUT 20,"DISP:TRAC:CURS1:POS 1000 Hz"

```

Analogously, **CURS2** activates the **\*-cursor** yielding the values **\*(A) - \*(B)** and **\*(X)**

Fig. 3-13 Cursor data o(A)-o(B), o(X), \*(A)-\*(B), \*(X)

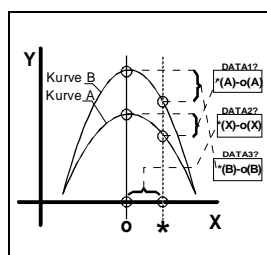

```

100 IEC OUT 20,"DISP:TRAC:CURS1 ACT;CURS2 ACT": 'Activates
o- and *-cursors
110 IEC OUT 20,"DISP:TRAC:CURS2:MODE C12"
120 IEC OUT 20,"DISP:TRAC:CURS1:POS:MODE VAL": 'o-cursor 1 kHz
130 IEC OUT 20,"DISP:TRAC:CURS1:POS 1000 Hz"
140 IEC OUT 20,"DISP:TRAC:CURS2:POS:MODE VAL": '*-cursor 2 kHz
150 IEC OUT 20,"DISP:TRAC:CURS2:POS 5000 Hz"

```

Fig. 3-14 Cursor data \*(A)-o(A), \*(X)-o(X), \*(B)-o(B)

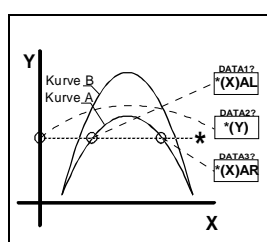

```

100 IEC OUT 20,"DISP:TRAC:CURS2 ACT": ' Activates *-cursor
110 IEC OUT 20,"DISP:TRAC:CURS2:MODE HL1"
120 IEC OUT 20,"DISP:TRAC:CURS2:POS:MODE VAL": 'Positions *-
cursor to
Y value 0.2 V
130 IEC OUT 20,"DISP:TRAC:CURS2:POS 0.2 V"

```

Analogously, cursor ...**CURS2:MODE HL2** yields values **\*(X)BL**, **\*(Y)** and **\*(X)BR** for **curve B**.

Fig. 3-15 Cursor data \*(X)AL, \*(Y), \*(X)AR

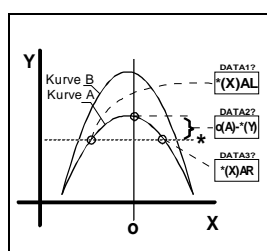

```

100 IEC OUT 20,"DISP:TRAC:CURS1 ACT;CURS2 ACT": 'Activates
o- and *-cursors
110 IEC OUT 20,"DISP:TRAC:CURS2:MODE HLD1"
120 IEC OUT 20,"DISP:TRAC:CURS1:POS:MODE VAL": 'Positions
o-cursor on 1000 Hz
130 IEC OUT 20,"DISP:TRAC:CURS1:POS 1000.0 Hz"
140 IEC OUT 20,"DISP:TRAC:CURS2:POS:MODE VAL": 'Positions
*-cursor on Y value 0.2 V.
150 IEC OUT 20,"DISP:TRAC:CURS2:POS 0.2 V"

```

Fig. 3-16 Cursor data \*(X)AL, o(A)-\*(Y), \*(X)AR

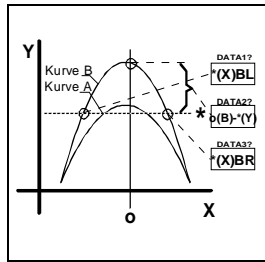

```

100 IEC OUT 20, "DISP:TRAC:CURS1 ACT;CURS2 ACT": 'Activates
                                     o- and *-cursors
110 IEC OUT 20, "DISP:TRAC:CURS2:MODE HLD2"
120 IEC OUT 20, "DISP:TRAC:CURS1:POS:MODE VAL": 'Positions
                                     o-cursor on 1000 Hz
130 IEC OUT 20, "DISP:TRAC:CURS1:POS 1000.0 Hz"
140 IEC OUT 20, "DISP:TRAC:CURS2:POS:MODE VAL": 'Positions
                                     *-cursor on Y value 0.2 V
150 IEC OUT 20, "DISP:TRAC:CURS2:POS 0.2 V"

```

Fig. 3-17 Cursor data \*(X)BL, o(B)-\*(Y), \*(X)BR

### Readout of cursor values

**DATA1?**, **DATA2?** and **DATA3?** values are read in with the following commands:

```

IECOUT 20, "DISP:TRAC:CURS:DATA1?": IEC IN 20, "D1$
IECOUT 20, "DISP:TRAC:CURS:DATA2?": IEC IN 20, "D2$
IECOUT 20, "DISP:TRAC:CURS:DATA3?": IEC IN 20, "D3$

```

**Values are output with the unit indicated in the display.**

### 3.15.18 Call a BASIC-Macro

With the UPL, setting and measurement sequences can be written as BASIC programs or recorded using the built-in program generator (see 3.15.3 Command Logging - Converting B10 into IEC/IEEE-Bus Commands). Option UPL-K2 (Universal Autorun Control) is required. The generated BASIC programs can be stored (preferred file extension: .BAS) and called and used in various ways (see Macro operating).

The following example illustrates how a BASIC macro is called by means of an IEC/IEEE-bus control program in the programming language C and the IEC/IEEE-bus driver GPIB.COM from National Instruments:

#### Example 1:

#### **BASIC macro transfers a measurement result in a measurement-result buffer to the control program**

##### **BASIC macro:**

A short program is written under Universal Autorun Control UPL-B10 to trigger a level in channel 1. To demonstrate that any data can be transferred to the IEC/IEEE-bus control program as floating-point values via the measurement-result buffers, the level of channel 1 (line 30) is copied into the measurement-result buffer of channel 2 (line 40), from where it is read with the aid of the IEC/IEEE-bus control program.

This BASIC macro is stored in the UPL under the file name LEV\_CH1.BAS.

```

10 UPL OUT "INIT:CONT OFF;*WAI"
20 UPL OUT "**TRG;*WAI"
30 UPL OUT "SENS:DATA?": UPL IN A$: ' level of channel 1 ...
40 UPL OUT "SENS:DATA2 "+A$: '... copying into buffer of channel 2
50 END

```

##### How to proceed:

- Press the F3 key to switch from the UPL user interface to Universal Autorun Control.
- Type the five lines shown above.
- Store program with SAVE LEV\_CH1.BAS.
- Press the F3 key again to return to UPL user interface.

The following IEC/IEEE-bus control program calls the BASIC macro in the UPL with the command SYST:PROG:EXEC 'LEV\_CH1.BAS'. There is a delay until serial polling indicates that bit 14 (RUN) has changed from 1 to 0 in the OPERation register; this indicates that the BASIC macro has been executed.

The measurement result is read from channel 2's measurement-result buffer and displayed on the screen.

#### IEC/IEEE-bus control program in controller:

```

/*****
* A BASIC program in UPL triggering a level-measurement result in channel 1
* To be started as a BASIC macro from the controller
* Measurement result to be output at the controller
*****/
#include <stdio.h>
#include <string.h>
#include <stdlib.h>
#include <conio.h>
#include <bios.h>
#include "C:\NI-GPIB\C\DECL.H"

void report_error(int fd, char *errmsg)
{
    fprintf(stderr, "Error %d: %s\n", iberr, errmsg);
    if (fd != -1) {
        printf("Cleanup: taking board off-line\n");
        ibonl(fd,0);
    }
    getch();
    exit(1);          /* abort program */
}

void befout (int upl, char *befstr)
{
    ibwrt(upl, befstr, (long)strlen(befstr));
    if (ibsta & ERR)
        report_error (upl, "Could not initialize UPL");
}

void queryin (int upl, char* reading)
{
    ibrd(upl, reading, 20L);
    if (ibsta & ERR)
        report_error (upl, "Could not read data from UPL");
    reading[ibcnt-1] = '\0'; /* Overwrites line feed with string terminator */
}

void main()
{
    int    upl;          /* File descriptor for UPL */
    int    i;
    char   reading[20]; /* UPL measurement results */
    long   count = 0;
    char   stb;

    if ((upl = ibdev(0, 20, 0, T10s, 1, 0)) < 0)
        report_error (upl, "Could not initialize UPL");

    befout (upl, "*ESE 0"); //Disables information from event status register
    befout (upl, "*SRE 0"); //Disables SRQ
}

```

```

/* The 1 -> 0 transition of bit 14 (RUN) in the OPERation register
   should set bit 7 (OPER) in the STB. The STB is read by means
   of serial poll until the event has occurred. */

befout (upl,"STAT:OPER:NTR 16384"); /* Enables 1->0 transition of bit 14 */
befout (upl,"STAT:OPER:PTR 0");    /* Disables 0->1 transition of bit 14
*/
befout (upl,"STAT:OPER:ENAB 16384"); /* Enables bit 14 for STB */

/* The BASIC program LEV_CH1.BAS in the UPL working directory writes
   the level measured in channel 1 to the measurement-result buffer of
   channel 2
   to demonstrate data transfer via the measurement-result buffers. */

for (i=1; i <= 10; i++)
{ /* Reads 10 measurement results via the BASIC macro LEV_CH1.BAS */
  /* Reading the EVENT part of the OPERation register deletes the
     OPER bit in the status byte register! */
  befout (upl,"STAT:OPER:EVEN?");
  queryin (upl,reading);

  befout (upl,"SYST:PROG:EXEC 'LEV_CH1.BAS'"); // Starts the BASIC macro

  /* When the RUN bit (bit 14) in the OPERation register changes from 1 to
     0, the BASIC macro has been executed and the measurement
     result can be read from the measurement-result buffer. */
  stb = 0;
  while ((stb & 0x80) == 0) // Serial poll is performed until
  { // bit 7 (OPER) in the STB is set to 1.
    ibrsp (upl,&stb); // Serial poll of the status byte register
    if ((count++ % 100) == 0) // Progress counter while
      printf ("+" ); // waiting for bit 7 = 1 */
  }

  /* The level of channel 1 can be read from the channel-2 measurement-
     result buffer, where it was stored by the BASIC macro. */
  befout (upl,"SENS:DATA2?");
  queryin (upl,reading);
  printf ("\n%s\n",reading);
}

printf ("Any key:\n");
getch ();
ibonl(upl, 0); /* Take UPL off-line */
}

```

#### Data transfer between BASIC macro and controller via the measurement-result buffers:

The measurement-result buffers can be written to so as to transfer data between the BASIC macro and the controller. The measurement results calculated by the macro can thus then be displayed in the UPL environment, which is familiar to the user.

Furthermore, fast exchange of floating-point parameters and floating-point measurement results between the UPL macro and the controller is possible via the measurement-result buffers. The following commands are available for the data exchange:

```

SENS1:DATA1, SENS1:DATA2
SENS2:DATA1, SENS2:DATA2
SENS3:DATA1, SENS3:DATA2

```

**Note:**

If the measurement results are not to be overwritten by the UPL measurement task, make sure the measurement task is halted, ie no measurement or sweep is being performed, while the measurement results are being written.

**Example 2:****BASIC macro transfers a set of data in a block buffer to the control program****BASIC macro:**

A short program is written under Universal Autorun Control UPL-B10. This program writes any set of data into the block buffer specially generated for BASIC macros. The data are then read from this buffer by the IEC/IEEE-bus control program.

This BASIC macro is stored in the UPL under BLK.BAS.

```
10 DIM A(1000): Frq=100: A(0)=X
20 FOR I=1 TO 999: ' 1000 log. frequency values ...
30 Frq=Frq*1.00503: A(I)=Frq: ' ... 100 Hz to 15 kHz
40 NEXT I
50 UPL BLOCKOUT A(0),1000
60 UPL OUT "SYST:PROG"
70 END
```

Proceed as for example 1.

The following IEC/IEEE-bus control program calls the BASIC macro in the UPL with the command SYST:PROG:EXEC 'BLK.BAS'. There is a delay until serial polling indicates that bit 14 (RUN) in the OPERATION register has changed from 1 to 0. This shows that the BASIC macro has been executed.

The block data are read from the block buffer and displayed on the screen.

**IEC/IEEE-bus control program in the controller:**

First part of program as in example 1

```
:
:
befout (upl,"SYST:PROG:EXEC 'BLK.BAS'"); // Starts the BASIC macro
stb = 0;
while ((stb & 0x80) == 0) // Serial poll is performed until
{
    // bit 7 (OPER) in the STB is set to 1.
    ibrsp (upl,&stb);
    if ((count++ % 100) == 0) // Progress counter while
        printf ("_"); // waiting for bit 7 = 1 */
}

/* Determines number of values in the block buffer */
befout (upl, "SYST:PROG:POIN?");
queryin (upl,reading);
points = atoi (reading);
printf ("\nBlock buffer contains %d values. Display values...\n",points);
getch();

/* Read values from block buffer */
befout (upl,"SYST:PROG?"); /* Fetch contents from block buffer.
    The values are available as ASCII characters separated
    by commas */
ibeos (upl,0x142C); //Stringterminator = ','
for (i = 0; i < points-1; i++)
```

```

    { // Each value is read up to the comma
      queryin (upl,reading);
      fltvalfield[i] = atof (reading);
    }
    // Before the last value has been read, the string terminator ...
    ibeos (upl,0x140A); //... is reset to AF.
    queryin (upl,reading);
    fltvalfield[i] = atof (reading);

    // Values are output on the screen.
    for (i = 0; i < points; i++)
      printf ("%d: %f\n", i+1, fltvalfield[i]);

printf ("Any key:\n");
getch ();
ibonl(upl, 0); /* Take UPL off-line */
}

```

### 3.15.19 Third analysis - Output of Block Data

Example of Programming for Universal Autorun Control UPL-B10:

The following program example shows the settings for the third analysis measurement function of a noise signal (1/3 OCTAVE measurement function in ANALYZER panel).

#### **Important!**

*The current level values of the 1/3 octave analysis are available under Scan Count 1 (line 200), the maximum level values of the max. hold function (line 60) under Scan Count 2 (line 210). The frequency list is queried with TRAC? LIST (line 140), the max. hold level values with TRAC? TRAC (line 260).*

```

10 REM ***** Third analysis - read out of Block Data *****
20 UPL OUT "RST": ' UPL default setup
30 UPL OUT "SOUR:FUNC RAND": ' Noise signal for generator
40 UPL OUT "INP:TYPE GEN2": ' Internal connection to generator channel 2
50 UPL OUT "SENS:FUNC 'THIR'": ' Switches on Third Analysis
60 UPL OUT "SENS:VOLT:INTV:MODE FOR": ' Max-hold function switched on
70 UPL OUT "DISP:TRAC:OPER FFTL": ' FFT data in tabular form
80 UPL OUT "INIT:CONT OFF": ' Selects single-measurement mode
90 UPL OUT "*TRG;*WAI": ' Triggers single-measurement
100 UPL OUT "TRAC:POIN? LIST": ' Request count of frequency values
110 UPL IN A$: Count=VAL(A$): ' Read out count of frequency values
120 PRINT "Count of freq. values: ";Count: INPUT "Go on.....";A$
130 DIM X(Count): ' Field for frequency values
140 UPL OUT "TRAC? LIST": ' Read out frequency values
150 UPL BLOCKIN X(0): ' Loads frequency block data into the data field X
160 FOR I=0 TO Count-1
170 PRINT X(I);"Hz ": ' Display frequency values
180 NEXT I
190 UPL OUT "DISP:TRAC:OPER SPEC": ' COUNT selection only avail. in SPEC
200 REM UPL OUT "DISP:TRAC:COUN 1": ' Choose current values of T. Analysis
210 UPL OUT "DISP:TRAC:COUN 2": ' Choose Max-hold values of Third Analysis
220 UPL OUT "TRAC:POIN? TRAC": ' Request count of level values
230 UPL IN A$: Count=VAL(A$): ' Read out count of level values
240 PRINT : PRINT "Count of level values: ";Count: INPUT "Go on.....";A$
250 DIM Y(Count): ' Field for level values
260 UPL OUT "TRAC? TRAC": ' Read out Max-hold level values
270 UPL BLOCKIN Y(0): ' Loads level block data into the data field Y
280 FOR I=0 TO Count-1
290 PRINT Y(I);"V ": ' Display level values
300 NEXT I
310 END

```



### 3.15.20 Binary Data via IEC/IEEE-Bus Interface

Using the IEC bus command `MMEMory:DATA 'filename', #<lele><le><Binärdaten>`, it is possible to transfer any binary data and files from the host to the UPL.

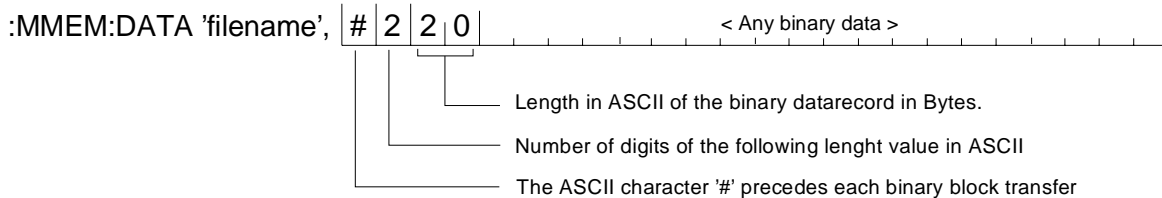

Using the IEC bus command `MMEMory:CHECK? 'filename'`, a digital signature can be calculated on the transferred binary data record in order to check whether an error occurred.

To ease the file transfer from host to the UPL not only experienced C- and IEC bus programmers the DOS programs `IEC_BT.EXE`, `RS232_BT.EXE` and `UPMD5.EXE` are provided from UPL version 2.0.

#### First Steps

After the installation of a new UPL software version 2.0 or higher, the following two EXE files are stored in the `C:\UPL\IEC_EXAM` directory (the EXE files can be run under DOS):

<code>IEC_BT.EXE</code>	(copied by a process controller from a file and transferred to UPL via the IEC/IEEE bus)
<code>RS232_BT.EXE</code>	(kopiert von einem Steuerrechner aus eine Datei über RS232-Schnittstelle zum UPL)
<code>UPMD5.EXE</code>	(generates the unique signature of a file)

The associated source code

`IEC_BT.C`  
`RS232_BT.BAS`  
 is stored too.

To be able to transfer a file from a process controller to the UPL via the IEC/IEEE-bus interface or RS232 control, the files `IEC_BT.EXE`, `RS232_BT.EXE` and `UPMD5.EXE` must be copied to a floppy disk and transferred from the disk to the process controller. The disk can be copied either on the UPL under DOS or, with the UPL measurement software running, from the FILE Panel using the commands 'Copy' and 'To'.

Important: The program `UPMD5.EXE` must be in the directory from which `IEC_BT.EXE` or `RS232_BT.BAS` is started, or in a directory specified under `PATH`.

#### Transfer of File to UPL via IEC/IEEE-Bus Interface

The program `IEC_BT.EXE` allow the transfer of any file to the UPL **via the IEC/IEEE-bus interface**.

This is done by transmitting then IEC bus command `MMEM:DATA` followed by then contents of the file to the UPL. The filename is specified interactively.

The source file `IEC_BT.C` is written in the programming language C. The source file provides information on the transfer procedure and the call-up of the MD5 signature method. `IEC_BT` can be adapted to user's requirements.

For the signature method to be executed, an IEC/IEEE-bus driver from National Instruments must be installed in the process controller, and the setting `Remote via IEC BUS` selected in the `OPTIONS` Panel of the UPL.

After `IEC_BT` is called up, the program tries to find

- an UPL connected to the IEC/IEEE bus. When an UPL has been found, measurements on UPL are stopped to obtain maximum transfer speed.
- The path and name of the file to be transferred are requested, as well as the path and name of the target file to be generated in the UPL.

- The program generates a temporary file with the name TEMP.OUT, which contains the IEC/IEEE-bus command required for the UPL as well as the data record to be transferred.
- TEMP.OUT is transferred to the UPL, followed by a final NL. The transfer rate between 30 and 100 Kbytes per second depends on the process controller and the UPL configuration. The file TEMP.OUT remains stored in the process controller after it is transferred so that it can be read if necessary by means of an editor capable of handling binary characters.
- At the end of the transfer, a signature is generated both of the original file stored in the process controller and the file generated in the UPL (see MD5 signature method). If the signatures agree, it can be assumed that the two files are completely identical and no transmission errors have occurred.

## Transmitting a File to UPL via RS232 Interface

see 3.17.5 Binary Data via RS232 Interface

### MD5 Signature Method

MD5 stands for "Message Digest 5" (coding and processing rule), an algorithm recognised world-wide which is used for generating a 128-bit checksum (Signature) of a data record.

To check whether a file was transferred error-free from the process controller to the UPL, the MD5 signature method can be used to generate the digital signature of the file on the process controller prior to the transfer. After the transfer of the file to the UPL via the IEC/IEEE bus, a digital signature is generated on the UPL. If the two signatures agree, it can be assumed that the contents of the files are identical and the transfer was therefore error-free. Moreover, it can be determined in this way whether any subsequent modifications have been made to the file.

The program UPMD5.EXE generates a 16-byte hexadecimal signature of any file. The signature is displayed as a 32-digit ASCII character string on the screen.

Example:

The signature of the file IEC\_BT.C is to be generated:

```
UPMD5 IEC_BT.C
```

ASCII character string displayed on the screen:

```
0d45494a3e3e262609e20050b5274f58
```

If the signature of a file is needed for further processing in a program, the signature can be written to a file instead of being displayed on the screen:

Example:

```
UPMD5 IEC_BT.C > IEC_BT.CHK
```

UPMD5.EXE can conveniently be called up as "child process" from its IEC/IEEE-bus or RS232 control program in order to evaluate the signature.

As an example in programming language C, here are the lines of source code IEC\_BT.C:

```
// Calculate MD5 checksum of host file. Pipe result to chkfile
sprintf (syststr,"UPMD5.EXE %s > %s",hostfile, chkfile);
// UPMD5.EXE child process prints checksum to chkfile
err = system (syststr); // Call MD5 data security child process
```

Example in QuickBASIC see source code RS232\_BT.BAS lines 53 and 54

```
shellcmd$ = "UPMD5.EXE " + hostfina$ + "> " + hostcheckfina$
```

```
SHELL (shellcmd$)
```

To fetch the signature of a file stored on the UPL via the IEC/IEEE bus or under RS232 control, the command

```
"MMEMory:CHECK? 'filename' "
```

is to be sent to the UPL.

The 32-digit signature of the requested file will be sent in return.

If 'filename' is specified without giving the path, the file will be searched in the current working directory of the UPL. The current working directory of the UPL is the directory specified under `Work Dir` in the FILE Panel of the UPL. The source code for the MD5 signature method is available on the Internet under [www.faqs.org/rfcs/rfc1321.html](http://www.faqs.org/rfcs/rfc1321.html)



## 3.16 Automatic Control of UPL with R&S BASIC

### **Important:**

*The software described below is an accessory for UPL and available under the designation UPL-B10 . It is not part of the equipment supplied with UPL.*

The program examples in the paths C:\UPL\B10\_EXAM\EXAM1.BAS ff of the UPL software can be directly run on the UPL with Universal Sequence Controller UPL-B10. Files with the extension .SAC are setup files required by the examples for setting the UPL. Files with the extension .TXT provide the program code of the examples as an ASCII file and can be accessed by any editor.

### 3.16.1 Use

Executing frequent test sequences in a fast and reproducible way, summing up the results and creating a valuable documentation, these are the applications of the UPL universal sequence controller using R&S BASIC. These automatic measurements, consisting of generator and analyzer functions of the UPL, are used for a full characterization of instruments and components in production or the test shop and for ensuring and monitoring the characteristics of system and transmission devices.

A universal sequence controller for automatic measurements does not only have to control the instrument functions, but must also be able to evaluate the measurement results and branch in the program. Besides, operator prompting with confirmations and indications is expected. Furthermore, synchronization with a time base or external events may be required. Thus, some programming is sometimes required, but it should be as simple as possible. Therefore, a complete BASIC interpreter with optimally integrated commands is used for operation of the measuring instrument. A simple keystroke permits to change between normal operation of the measuring instrument and BASIC. The command extensions for the instrument control feature the same structure as the IEC/IEEE-bus commands, which in turn comply with the international SCPI standard.

### 3.16.2 Scope of Functions

The UPL provides about 600 elements (ie functions in the programming language) and almost as many keywords as parameters. Therefore, users not wishing to do any programming, but also experts will appreciate the integrated program generator. Every input via front panel or keyboard for setting the UPL is recorded in logging mode and added to the program as a complete program line. Simple test sequences are thus completely programmed without having typed a single line. There is no need to check the correct syntax, the created program can be easily read due to the standard SCPI notation and is thus simple to modify and supplement.

R&S BASIC with easy-to-handle IEC/IEEE-bus commands that are optimally incorporated into the syntax can also control further IEC/IEEE-bus devices without the need for an external controller. (This requires the Remote Control option UPL-B4). Likewise, it is straightforward to operate the serial interface and write and read files for connection with peripheral devices or other programs.

For graphical output, BASIC can fully make use of the UPL software: Graphs with sophisticated scaling and labelling, bargraphs, bargraphs with trailing pointers, all of them also with automatic scaling depending on the measured value, are still available. In addition, the graphics commands belonging to BASIC can also be used.

If the UPL is to be controlled by an external controller in a test system, two REPLACE commands can be used to convert all UPL IN/OUT instructions into IEC/IEEE commands (IEC IN/OUT). This constitutes the basic program for controlling the UPL.

### 3.16.3 Preparation for Use

If the Universal Sequence Controller UPL-B10 is ordered together with the UPL it is immediately ready for use. When retrofitted, it has to be enabled by means of an installation key. A key matching the serial number of the UPL is supplied to the user to activate the software.

Subsequently, a memory model for BASIC can be selected by calling UPLSET. The user has to indicate how much memory he wants to reserve for the BASIC program and BASIC data (variables). Since the UPL cannot simultaneously be remote-controlled via the IEC/IEEE bus and the Universal Sequence Controller UPL-B10, the user must choose between the two modes by means of UPLSET. The files CONFIG.SYS and UPL.BAT are thus changed.

-UPLSET contains a menu through which the user is guided:

➤ Enter "UPLSET" and "↵" after the prompt c:>.

The selected operating mode is maintained even after instrument switch-off.

To estimate the required memory, the following empirical values are given: A typical BASIC line requires about 25 bytes. A 13k program memory is thus sufficient for about 500 lines or 10 pages of program. The remaining empty memory can be polled in BASIC with FRE(1). A variable in BASIC requires about 15 bytes (depending on the length of the name), and a field with floating-point numbers requires 8 bytes for each index. FRE(o) indicates the remaining storage area.

The memory should not be oversized, since the program may be limited in its speed from a certain size onwards (see also Section 3.16.4.11 UPL/Basic Memory Management - UPL-B10). If the preset values are not exceeded, the UPL operates at full speed.

In the case of first installation, the UPL must be booted anew; otherwise this is only necessary when the memory model is changed. UPLSET can also be called in order to poll about the currently active memory allocation. If the UPL is to operate again as a measuring instrument controlled externally via IEC/IEEE bus, UPLSET can be used to return to this mode.

### 3.16.4 Operation

In the following, a distinction is made between BASIC and the UPL program, the latter including all routines except BASIC (i.e. the test, readout, graphics output and input routines).

#### 3.16.4.1 Switchover between UPL and BASIC Entry Mode

- **Switchover from UPL to BASIC entry mode:**

Use function key **F3** on the **external keyboard** or **BACKSP** on the front panel. With BASIC in the entry mode, the fields for reading out measured values are displayed at the upper edge irrespective of whether full graphics display is selected in the UPL or not. The field below down to the softkeys is available to BASIC.

Possible error messages after pressing the F3 key: When the message "BASIC not installed" is displayed, BASIC has not been installed at all or incorrectly. "Memory not available" indicates that a memory size exceeding the available space has been selected with UPLSET.

- **Entry in the BASIC mode:**

All characters can be entered from the external keyboard as required. A limited control is also possible from the UPL front panel:

Keys of the front-panel key blocks DATA/PANEL and EDIT as well as the CURSOR keys have the common functions.

Exceptions:

SELECT = blank

+/- = - (minus)

The keys of the CONTROL block as well as HELP, the tabulator and PgUp/Dn keys in the CURSOR/VARIATION block have no function.

Letters cannot be output with the front-panel keys but the entry of numerals opens up plenty of possibilities for controlling a BASIC program without the burden of an external keyboard.

While BASIC waits for a line entry (as after pressing of the "↵"-key), the UPL program continues to run in the background and the measurement results are displayed. The effects of the settings made by BASIC can thus be observed immediately. However, after the first character has been entered, the UPL program is not called up any more. No measurements are performed and the printer spooler (HCOPY) does not run in the background until the entry is terminated with "↵".

**Note:**

*When the UPL is controlled with BASIC, printing with H COPY is considerably slowed down as the available computing time must be divided up. There will be more time for the printout if the measurement is stopped using the STOP key on the front panel.*

- **Switching back from BASIC to UPL entry mode:**

Key **F3** on the **external keyboard** or the keys **ENTER** and then **LOCAL** on the **front panel**.

When switching back to UPL control the panels are completely restored to show the current settings as there may have been changes under BASIC. BASIC is inactive but the last-set status will be retained.

### 3.16.4.2 First Steps (Readout of Measurement Results)

Program example:

Triggering 10 measurement results and output on the screen.

- Press key F3 of the external keyboard from the UPL user interface. The result display field appears at the top of the screen, the softkey lines at the bottom. "R&S-BASIC version..." is displayed in the screen center.
- Enter the following program (including line numbers 10-90).

```

10 UPL OUT "*RST": '                               UPL default setting
20 UPL OUT "INP:TYPE GEN2": 'Internal connection to generator channel 2
30 FOR I=1 TO 10
40 UPL OUT "INIT:CONT OFF;*WAI": '               Triggers a single measurement
50 UPL OUT "SENS:DATA?": Requests function test result from channel 1
60 UPL IN M$: '                                   Reads in measurement result
70 PRINT M$: '                                   Prints measurement result
80 NEXT
90 END

```

- Start the program with F6:

Due to the default setting made with \*RST (see Appendix A **UPL Default Setup**), the UPL generator produces a 1-kHz sinewave signal with a level of 0.5 V.

Command INP:TYPE GEN2 internally links generator channel 2 and analyzer channel 1 so that cabling between inputs and outputs is not required for this first test. The UPL analyzer performs 10 RMS measurements and the results are displayed on the UPL screen.

**Note:**

*To display a measurement result on the screen it must first be triggered (line 40). After triggering a settled result is available which can be requested (line 50), read out (line 60) and displayed on the UPL screen (line 70).*

- Return to manual operation: Press F3 on the external keyboard or ENTER and then LOCAL on the front panel.

### 3.16.4.3 Logging Mode

Function key F2 switches the logging mode on or off. The respective mode is indicated in the bottom righthand corner above the softkeys. In the case of "on", all entries used for setting the UPL are appended to the BASIC program as a command line. After switching to the BASIC mode, these new lines are displayed automatically and may be modified.

The BASIC commands for automatic control of the UPL differ only slightly from the commands for remote control via the IEC/IEEE bus. The program can easily be converted into the other commands using the BASIC command REPLACE (eg for controlling the UPL with an external controller). See also UPL-specific modifications of the BASIC manual, paragraph REPLACE. A detailed example is given in section 3.15.3 Command Logging - Converting B10 into IEC/IEEE-Bus Commands.

### 3.16.4.4 Differences to IEC/IEEE-Bus Remote Control

The differences between the R&S BASIC commands of the universal sequence controller and the R&S BASIC commands of the IEC/IEEE-bus control are illustrated by way of examples:

#### Delimiters of character strings, Timeout

R&S BASIC command	R&S IEC/IEEE-bus command
A delimiter need not be specified for the transfer of a character string.	10 IEC TERM 10 Controller expects LF as delimiter for an UPL response
Waits indefinitely for a response. However, in special cases the time can be monitored by querying bit d0 (OPC) of the Event Status Register in a loop until the bit assumes the value 1 which signals that a measurement result is available. The program example is given under "Other differences to IEC/IEEE-bus remote control" further down in this section.	10 IEC TIME 5000 The controller does not wait longer than 5 s for a response from the UPL before an IEC/IEEE-bus timeout is signalled.

#### Output of commands

R&S BASIC command	R&S IEC/IEEE bus command
10 <b>UPL OUT</b> "SOUR:FREQ 1000Hz" (sets generator frequency)  Transfers a character string (constant in quotes, variable denoted with \$ or a character string expression) to the UPL program.	10 IEC OUT 20, " SOUR:FREQ 1000Hz "

#### Reading in responses

R&S BASIC command	R&S IEC/IEEE-bus command
100 UPL OUT "SENS:DATA2?" 110 <b>UPL IN</b> A\$ (transfers the measured value of channel 2 to the variable A\$ for processing)  Takes a character string from the UPL program. This may be a measured value or a queried setting. The information to be taken must first be defined in a query (command with question mark).	100 IEC OUT 20, "SENS:DATA2?" 110 IEC IN 20, A\$



Output of block data

R&S BASIC command	R&S IEC/IEEE-bus command
<pre>10 DIM A(20) 20 Frqval = 20 30 FOR I = 0 TO 19 40 A(I) = Frqval 50 Frqval = Frqval*1.44 60 NEXT I 70 UPL BLOCKOUT A(0),20 80 UPL OUT "sour:list:freq" (transfer of 20 values for a frequency list sweep to the UPL)</pre> <p><b>UPL BLOCKOUT &lt;array(i)&gt;[,n]</b></p> <p>Stores block data in a reserved communication range of the UPL so that they can be transferred subsequently from BASIC to the UPL with an UPL OUT "...." command. This applies, for instance, to the transfer of lists or values for graphic display. The index <i>i</i> indicates the value from which onwards the data field is to be transferred. <i>n</i> defines the number of values. If <i>n</i> is not specified, the quantity defined with DIM will be used.</p>	<pre>10 DIM A(20) 20 ' Combines block data to a string 30 Bef\$="SOUR:LIST:FREQ" 40 Frqval=20 50 FOR I=0 TO 19 60 Bef\$=Bef\$+STR\$(INT(Frqval)) 70 IF I&lt;19 THEN Bef\$=Bef\$+", " 80 Frqval=Frqval*1.44 90 NEXT I 100 IEC OUT 20,Bef\$</pre>

Reading out block data

R&S BASIC command	R&S IEC/IEEE-bus command
<pre>10 DIM A(200) 20 UPL OUT "TRAC? TRAC" 30 UPL BLOCKIN A(0) 40 UPL OUT "TRAC:POIN? TRAC" 50 UPLIN A\$:Count = VAL(A\$) (loads a sweep list in the form of block data from the UPL into field A() of BASIC and loads the data into Count)</pre> <p><b>UPL BLOCKIN &lt;array(i)&gt;</b></p> <p>loads block data (ie lists or a measurement sequence) from the UPL program into a data field (index variable) for further processing. Same as with UPL IN the data to be read must first be defined in a query (sour:list:freq?). <i>i</i> denotes the index from which the first value of a block is stored. The list is always used in full length, ie a sufficiently large data field has first to be defined with DIM.</p>	<pre>10 DIM A (200) 20 IEC OUT 20,"TRAC:POIN? TRAC" 30 IEC IN 20,Count\$: Count=VAL(Count\$) 40 IEC OUT 20,"TRAC? TRAC" 50 IEC TERM 44: ' Sets string term. to ',' (0x2C = 44d) 60 FOR I=0 TO Count-2: ' Reads in n - 1 values 70 IEC IN 20,A\$: DIM(I) = VAL(A\$) 80 NEXT I 90 ' Reads last value 100 IEC TERM 10: ' Resets string term. to LF 110 IEC IN 20,A\$: DIM(Count-1) = VAL(A\$)</pre>

Switchover to UPL user interface

R&S BASIC command	R&S IEC/IEEE-bus command
<p><b>UPL GTL (Go To Local)</b></p> <p>With this command BASIC is quit and the UPL screen is displayed. Control is also transferred to the UPL and entries can be made in the UPL panels. To return to BASIC the F3 key has to be pressed.</p> <p>This means that in the program mode this command has the same function as the F3 key (switchover from BASIC to UPL). If the operator now presses F3, control is switched back and BASIC continues with the command that follows UPL GTL in the program. When entered in the BASIC direct mode, this command has the same function as the F3 key.</p> <p><b>Note:</b>  <i>After a BASIC program has been started with RUN, key F3 is disabled. It is enabled again only after END, STOP or abort (with Ctrl/Break) in the BASIC entry mode.</i></p> <p><b>UPL GTL U (Go To Local, temporarily with UPL screen)</b></p> <p>This command is required when the UPL display should be used under BASIC. Thus an ongoing sweep or FFT can be monitored (provided a measurement was started before, the display is continuously updated) or values computed in BASIC are to be displayed. (These values have to be transferred first from BASIC to UPL using the UPL BLOCKOUT command).</p> <p>The panel displayed at the left of the graphics window can be used by BASIC for PRINT outputs. A line must not be longer than 26 characters, however, as otherwise the graphics window will be overwritten. After the UPL GTL U command, the screen scroll is stopped to avoid the graphic display being shifted and destroyed when the first or the last line is reached (in the case of uncontrolled PRINT outputs). Status lines 1 and 2 cannot be used either as this space is occupied by the UPL display.</p> <p>With this command the BASIC display is stored and the UPL screen displayed. Control is not transferred to the UPL, however, and entries cannot be made in the UPL panels. Immediately after display of the UPL screen, control is handed back to BASIC without the BASIC display being restored.</p> <p>Use the GTL B command described below to restore the BASIC display. After an UPL GTL U command and before terminating the program with END, STOP or abort (with Ctrl/Break or in case of a fault) the operator should restore the BASIC display as otherwise no entries can be made, eg in the UPL full-screen mode. As an aid for the operator, the BASIC display is automatically restored when the BASIC entry mode is reached (entry of commands or program instructions) with the consequence that UPL GTL B is performed immediately when UPL GTL U command is entered in the direct mode and the entry has no effect.</p> <p><b>UPL OUT "DISP:ACT ON   OFF"</b></p> <p>This command is of interest in conjunction with GTL U. The OFF state prevents the graphics display being updated after every control command as this might be disturbing and slow down program execution. With ON the display is completely restored and then continually updated. The OFF and ON commands are to be used together as a pair as otherwise the UPL graphics display is not restored, not even when the UPL is manually controlled.</p>	<p>IEC LAD 20  IEC GTL</p>

<p><b>UPL GTL B (set BASIC screen)</b></p> <p>This command is only needed with UPL GTL U. It restores the BASIC screen displayed before the UPL display set up with UPL GTL, UPL GTL U or with the F3 key (change from BASIC to UPL control).</p> <p><b>UPL GTL G (draw UPL graphic)</b></p> <p>This command is needed when the UPL graphics display is to be used under BASIC. The display is restored but not subsequently updated as is the case with UPL GTL U. Thus values computed in BASIC, for instance, can be displayed (the values have to be transferred first from BASIC to the UPL using the UPL BLOCKOUT command). The operator can make full use of the UPL graphics display with scales and labels.</p> <p>The graphics display must be switched on of course (with command UPL OUT "disp:conf ...." using parameters xP or P, or previously in manual control). Note: Upon loading a setup, the 3-panel display may be selected which has the effect of switching off the graphics display. In case of doubt check the setting by changing to the UPL mode.</p> <p>When the result output has been activated (set to display) using UPL OUT "disp:ann on" also the measurement results in the display field at the screen top are updated.</p> <p>Contrary to F3, UPL GTL or UPL GTL U, the BASIC screen is not stored and the UPL display set up, but the UPL graphics display is integrated in the BASIC screen. Like any other graphic drawn under BASIC, the display is shifted together with the text when the cursor reaches the top or bottom edge. The graphic may also be overwritten by text (in this case the background is blanked) irrespective of whether this is useful or not.</p> <p>When the display is shifted, which can always be prevented by adequately positioning the cursor (see section 3.16.4.8 STRINX.SYS Driver for Screen and Keyboard - UPL-B10), parts of the graphics display remain visible at the upper or lower edge of the scroll window as the scrolled parts are shifted in multiples of the text size, which do not correspond to the UPL graphic displayed.</p> <p>Since the UPL graphic has become part of the BASIC screen it is always restored when the UPL display is switched over to BASIC with the F3 key. It is cleared together with the BASIC text screen using the sequence PRINT "Esc[2J". CLEAR also clears the screen or parts thereof (see section 3.16.4.5 UPL-specific Modifications to the Basic Manual - UPL-B10 under CLEAR).</p>	
--	--

**Further differences to IEC/IEEE-bus remote control:**

- An SRQ procedure cannot be programmed in R&S BASIC of the Universal Sequence Controller UPL-B10, ie the control program cannot perform other tasks while waiting for measurement results or error messages from the UPL. Error queue or the status registers must be queried cyclically in the control program.
- Since the UPL does not generate an SRQ for the Universal Sequence Controller UPL-B10, there is no need to determine the sender or source of the SRQ by means of a serial or parallel poll. This should not be mixed up with the possibility of using the UPL as an IEC/IEEE-bus controller and to control other instruments on the IEC/IEEE bus from the Universal Sequence Controller UPL-B10 (described in the manual R&S BASIC Interpreter supplied with the UPL-B10 option).
- Line messages like REN, GET, DCL, etc are not possible.
- The line message EOI denoting the end of a binary block cannot be used. Binary block data cannot be received. The command " FORMat REAL" is ineffective. Block data can only be received with command UPL BLOCKIN described above.

- In R&S BASIC of the Universal Sequence Controller UPL-B10 all common commands referring to SRQ control are not relevant. Respective information can be obtained from the table under 3.9 Common Commands.

An exception is the \*OPC command. Although mainly intended to trigger an SRQ when a measurement result is relevant, under R&S BASIC this command may be used to wait for a measurement result in a loop by querying the bit d0 of the Event Status Register:

Example:

```
110 UPL OUT "*OPC;*TRG": ' Triggers measurement result
120 Brk=0: I=0
130 WHILE (Brk=0) AND (I<=100)
140   UPL OUT "*ESR?"
150   I=I+1: UPL IN Esr$: IF (VAL(Esr$) AND 1)<>0 THEN Brk=1: ' Queries OPC
160 WEND
170 IF I>100 THEN PRINT "Timeout": STOP
180 UPL OUT "SENS:DATA?": ' Requests measured value
190 UPL IN M$: PRINT M$: ' Reads and output measured value
```

- Common commands (3.13.1) and addressed commands (3.13.2) are not available for the Universal Sequence Controller UPL-B10.
- All registers and commands of the status reporting system which are not related to SRQ generation can be used:

*STB?	not usable
*SRE	not usable
*PRE	not usable
*IST?	not usable
<b>*ESR?</b>	<b>usable</b>
*ESE	not usable
<b>STATus:OPERation?</b>	<b>usable</b>
<b>STATus:QUEStionable?</b>	<b>usable</b>
<b>STATus:XQUEstionable?</b>	<b>usable</b>
<b>SYSTEM:ERRor?</b>	<b>usable</b>

- Note:**

*If UPL with Universal Sequence Controller UPL-B10 is used as a controller for **other IEC/IEEE-bus devices** (described in the R&S BASIC Interpreter manual supplied with the UPL-B10 option), and should **again** be controlled by another controller as a talker/listener **on the IEC/IEEE bus**, IEC/IEEE-bus control must be released by the Universal Sequence Controller UPL-B10 with command IECRLC (IEC ReLease Control) .*

### 3.16.4.5 UPL-Specific Modifications to the BASIC Manual

There are only a few modifications to the supplied standard BASIC manual which result from different conditions. In the part of the manual dealing with process controllers, the BASIC manual of the PSA and PAT controller versions is valid.

#### Softkey labelling and function keys

As against the standard BASIC manual, the function keys are shifted by 4 keys as F1 to F4 are assigned different functions in the UPL. The softkey labelling has been adapted accordingly for the UPL. Switchover between alphanumeric and graphics mode ( F8) is not provided in the UPL.

#### BYE

is a synonym for EXIT; description see under EXIT.

#### CLEAR [ 1 | 2 | 3 ]

This command clears the screen or parts of it. The size of the parts corresponds to the UPL panels or fields. The commands always clear the indicated parts irrespective of whether they are assigned UPL fields or not.

Without parameter specified, the upper part of the screen is cleared, however without the output field for measured values.



CLEAR 1 clears the output field for measured values



CLEAR 2 clears the field at the left of the graphic display.



CLEAR 3 clears the UPL graphics.



**COLOR**

should not be modified to avoid changing of the UPL graphics output. The colours are assigned as follows:

Pen	UPL colour mode	UPL b/w mode
0	white	white (background)
1	dark grey	white
2	white	black
3	red	black
4	grey	grey
5	yellow	light grey
6	dark grey	dark grey
7	yellow	dark grey
8	green	grey
9	green	black
10	blue	black
11	green	black
12	yellow	grey
13	cyan	dark grey
14	black	black
15	black	black (preselected colour)

**COPYOUT**

is not supported. See GSAVE "LPT1".

**EXIT (Synonym for BYE)**

leaves the BASIC mode and returns to the UPL input mode and not to MS-DOS.

**GRAPHIC**

The interface name for putting out graphics on the screen is no longer GRAPH but GRAPX with the UPL.

**GSAVE on LPT**

is not supported. Instead, the HCOP:DEST <> remote-control command should be used for a printout of the display.

**HELP**

is not supported as a command.

**HOLD****Note:**

*During the wait time the routines are not continued. Therefore, with long times, the wait time should better be implemented with a loop using TIME.*

**REPLACE**

To allow also the comma to be contained in the REPLACE command as part of the string (and not as separator between the new and the old string), it has to be preceded by a backslash (\,).

**Example 1:**

```
old program: 100 UPL OUT A$
REPLACE UPL OUT, IEC OUT 20,
new program: 100 IEC OUT 20,A$
```

**Example 2:**

```
old program: 100 IEC IN 20, A$
REPLACE IEC IN 20\,, UPL IN
new program: 100 UPL IN A$
```

**SCREEN**

is not supported; SCREEN 18 (VGA mode with 16 colours/grey shades) is always set.

**SET**

The colour of the pen is selected from the colours described above under COLOR.

**SHELL**

is only supported with restrictions, since the remaining memory of approx. 60 Kbytes is too small; the MS-DOS command interpreter together with the program called must not exceed this memory size. However, this is the case with the internal and a few external MS-DOS commands (dir, del, md, cd etc, see MS-DOS manual).

**VIEWPORT**

The upper limit for y2 should be 294 so that the upper field remains vacant for readout of the measured values. In principal, there are no restrictions to the BASIC graphics commands, it is up to the user whether the area used by the UPL graphics is overwritten.

**WINDOW**

The preselected values are 0,639,0,293.

**ZOOM**

is not supported

### 3.16.4.6 BASIC Screen

The screen contains 30 text lines, 5 at the lower edge being reserved for softkeys and two lines for status indication. One status line is used by BASIC, the other is available to the user (see labels of status lines and softkeys).

Two modes are provided for the upper 25 lines: either BASIC uses all lines or the UPL builds up a field for the output of measured values at the top edge, where the measurement results are continuously updated. This field comprises 7 text lines and reduces the BASIC text window to 18 lines. The second mode is activated using UPL OUT "disp:ann on".

Inside the 25/18-line window, the text is scrolled when the cursor reaches the top or bottom edge. If this window contains a graphic, the latter is shifted as well. This also applies to graphics drawn by the UPL software. However, since the graphics are slightly larger than the text window, which is variable in steps of 16 pixels only (text size), they seem to be somewhat "torn". By positioning the text appropriately, the user must ensure not to write outside the text window (which causes a shift).

The command PRINT "Esc (2)" clears the 18- or 25-line window depending on the mode. The CLEAR command (without parameter) only clears the 18-line window (without the area reserved for the output of measured values). The BASIC extensions CLEAR 1½ 2½ 3 clear the panel fields or the output field for measured values irrespective of whether they contain UPL panels or not (see section 3.16.4.5 UPL-specific Modifications to the Basic Manual - UPL-B10).

If text is entered for BASIC, BASIC does not get the keyboard entries but reads out the screen contents. If graphics are superimposed on this text, it is possible that the character is not identified and BASIC responds with an error message. Even the space between the last character and the right-hand screen edge is significant if it can be interpreted as a blank or character. Therefore, the user should write at a "clean" position, or go to a position by scrolling the text before writing.

### 3.16.4.7 Control Commands Unsuitable for Logging

The control commands are described in detail in the UPL manual, classified according to their function and then in alphabetical order. Furthermore, almost all commands can be logged in manual operation, the commands being created in the correct notation and added to the program.

Commands for reading out measured values and control commands via the front-panel keys in the CONTROL block cannot be logged. They are briefly summed up in the following.

CONTROL key commands:

START	UPL OUT "init:cont on"
	UPL OUT "init"
SNGL	UPL OUT "init:cont off"
STOP	UPL OUT "abort"
HCOPY	UPL OUT "hcop"
LCD ON/OFF	UPL OUT "disp:enab on" adv. off
OUTPUT ON/OFF	-----
LOCAL	UPL GTL

Commands for reading out single measurement results:

Function CH1:	UPL OUT "sens:data?":UPL IN Aα
Function CH2:	UPL OUT "sens:data2?":UPL IN Aα
Input PEAK CH1:	UPL OUT "sens2:data?":UPL IN Aα
Input PEAK CH2:	UPL OUT "sens2:data2?":UPL IN Aα
Freq CH1:	UPL OUT "sens3:data?":UPL IN Aα
Freq CH2:	UPL OUT "sens3:data2?":UPL IN Aα
Phase:	UPL OUT "sens4:data2?":UPL IN Aα

Commands for reading out block data:

Trace A:	UPL OUT "trac? trac1":UPL BLOCKIN A(0)
Trace B:	UPL OUT "trac? trac2":UPL BLOCKIN B(0)
X values:	UPL OUT "trac? list1":UPL BLOCKIN X(0)
Z values:	UPL OUT "trac? list2":UPL BLOCKIN Z(0)

Command for synchronization:

UPL OUT "\*/WAI"



### 3.16.4.8 Driver for Screen and Keyboard STRINX.SYS

An internationally standardized software interface based on the ANSI standard X 3.41-1774 is provided for addressing the screen. This standard defines all functions required to operate a terminal. The most important functions of this standard as well as certain functions mainly required for operating the BASIC editor are implemented in the STRINX device driver.

This driver is loaded when booting the operating system, if  
`DEVICE = C:\UPL\DRIVER\STRINX.SYS`  
 is contained in the configuration file CONFIG.SYS.

The following function groups are supported:

- Cursor control
- Labelling of status lines and softkeys
- Clearing screen areas
- Editing screen
- Setting the video attributes.

If the appropriate ANSI sequence can be assigned parameters P1; P2 ...; Pn, they must be entered as decimal numbers with one or two digits. The individual parameters are separated by semicolons.

The STRINX.SYS driver is to be used exclusively for programming in R&S BASIC. With this driver, the UPL is largely compatible with the PSA. ANSI.SYS has to be loaded for programs using the control sequences of the ANSI standard.

#### Cursor Control

The cursor can be set to absolute or relative positions. The output of new characters is continued starting at the set position.

Table 3.18 Cursor Control (UPL-B10)

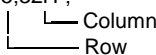
Cursor function	Sequence	Example in BASIC
Free positioning (one parameter may be omitted)	ESC[P <sub>1</sub> ; P <sub>2</sub> H *)	? "E <sub>c</sub> [05;32H"; 
Shift cursor by P <sub>n</sub> positions ↑ Shift cursor by P <sub>n</sub> positions ↓ Shift cursor by P <sub>n</sub> positions → Shift cursor by P <sub>n</sub> positions ← (P <sub>n</sub> with one digit only)	ESC[P <sub>n</sub> A ESC[P <sub>n</sub> B ESC[P <sub>n</sub> C ESC[P <sub>n</sub> D	? "E <sub>c</sub> [5A"; ? "E <sub>c</sub> [3B"; ? "E <sub>c</sub> [3C"; ? "E <sub>c</sub> [5D";
Shift cursor by one position ↑ ↓ with scrolling	ESC[ : A ESC[ : B	? "E <sub>c</sub> [ :A"; ? "E <sub>c</sub> [ :B";
Store cursor position / recall cursor position	ESC[ s ESC[ u	? "E <sub>c</sub> [s"; ? "E <sub>c</sub> [u";
Switch off cursor Switch on cursor	ESC[ h ESC[ l	? "E <sub>c</sub> [h"; ? "E <sub>c</sub> [l";

\*) ESC means the key "Esc" or the keyboard code 1BH or 27 decimal

**Labelling of Status Lines and Softkeys**

Table 3.19 Labelling of Status Lines and Softkeys (UPL-B10)

Function	Sequence	Example in BASIC
Label status lines	ESCQP <sub>n</sub> TEXT	?”E <sub>c</sub> Q3TEXT”
Label softkeys	ESCRP <sub>n</sub> TEXT	?”E <sub>c</sub> R4TEXT”

**Note:**

*The sequences must be terminated by LF (ASCII code 10).*

Softkeys 1 to 4 cannot be labelled as they have been assigned important basic functions that must be available in all program states.

Status and softkey lines are labelled as follows:

Table 3.20 Labelling of Softkeys (UPL-B10)

Screen lines	VGA graphics mode *)
First	25 Q1 26 Q2, Q 27 Q3 28 Q4, softk.
Last	29 Q5

\*) Compatible with PSA mode

If one of the softkeys is labelled, the PSA compatibility mode is switched on (return with sequence "ESC[1j"). The keyboard codes are converted to the corresponding values of the PSA according to the following table:

Table 3.21 Labelling of Softkeys, Conversion table (UPL-B10)

PSA code	PC comp. scan code	Keyboard labels	
		German keyboard	American keyboard
0E0H	3B	F1	F1
0E1H	3C	F2	F2
0E2H	3D	F3	F3
0E3H	3E	F4	F5
0E4H	3F	F5	F4
0E5H	40	F6	F6
0E6H	41	F7	F7
0E7H	42	F8	F8
0E8H	43	F9	F9
0E9H	44	F10	F10
0EAH	45	F11	F11
0EBH	46	F12	F12
0B7H	47	Pos 1 7	Home
0B8H	48	↑ 8	↑
0B9H	49	Bild ↑ 9	Pg Up
0B4H	4B	← 4	←
0B6H	4D	→ 6	→
0B1H	4F	Ende 1	End
0B2H	50	↓ 2	↓
0B3H	51	Bild ↓ 3	Pg Dn
0B0H	52	Einfg 0	Ins
0AEH	53	Entf .	Del

**Editing the screen**

Table 3.22 Editing the screen (UPL-B10)

Action	Sequence	Example
Insert blank lines	ESC[ P <sub>n</sub> L	?”E <sub>c</sub> [ 5L”
Delete lines	ESC[ P <sub>n</sub> M	?”E <sub>c</sub> [ 3M”

**Clearing Screen Area**

Table 3.23 Clearing Screen Area (UPL-B10)

Cursor function	Sequence	Example in R&S BASIC
Clear screen, Cursor ↵	ESC[ 2J	?”E <sub>c</sub> [ 2J”
Clear complete video RAM, Cursor ↵	ESC[ 3J	?”E <sub>c</sub> [ 3J”
Clear from cursor to end of screen	ESC[ J	?”E <sub>c</sub> [ J”
Clear from cursor to end of line	ESC[ K	?”E <sub>c</sub> [ K”
Clear status and softkey lines <b>Note:</b> The sequence must be terminated by LF.	ESC[ y	?”E <sub>c</sub> [ y”

**Setting the colours**

Colours may be assigned to each character output on the screen. The colours are also set via the ANSI interface.

Table 3.24 Setting the colours (UPL-B10)

Colour	b/w	Sequence	Example in R&S BASIC
light grey	light grey	ESC[ 91m	?”E <sub>c</sub> [ 91m”
light grey	light grey	ESC[ 92m	?”E <sub>c</sub> [ 92m”
yellow	white	ESC[ 93m	?”E <sub>c</sub> [ 93m”
----	----	ESC[ 94m	?”E <sub>c</sub> [ 94m”
blue	black	ESC[ 95m	?”E <sub>c</sub> [ 95m”
dark grey	dark grey	ESC[ 96m	?”E <sub>c</sub> [ 96m”
black	black	ESC[ 97m	?”E <sub>c</sub> [ 97m”
black	black	ESC[ 98m	?”E <sub>c</sub> [ 98m”

### 3.16.4.9 Operation of Serial Interfaces COM1 and COM2

The transmission rate, parity bit, number of data and stop bits as well as the error handling mode of the serial interfaces can be configured using the MS-DOS MODE program, which is described in section **2.17 Connecting External Devices** or in the DOS manual (DOS commands). Configuration is made either automatically on calling the AUTOEXEC.BAT program, in the operating system by means of an entry via the keyboard, or in BASIC using the SHELL command. Example:

```
10 SHELL "mode com2: baud=24 parity=e data=7 stop=1 retry=n >NUL"
```

The last instruction for rerouting to the NUL device ensures that MODE does not output the response on the screen, but suppresses it.

The serial interface designated COM1 or COM2 is prepared for the output using the PRINT# command. As with every PRINT command, CR and LF are added to the string to be output if the line is not terminated by a comma or semicolon. Example:

```
10 OPENO #1, "com1:"
20 PRINT #1, A$
```

If the acknowledge lines DSR and CTS are not active, the operating system outputs the error message "ERROR 74 IN LINE xx: DOS: write fault".

The interfaces are prepared for reception using the OPEN command. With the subsequent INPUT# command, characters are read in until a CR is received. If the sending device continues to transmit characters, these characters must immediately be read in using the next INPUT# command, otherwise they are lost and an error is signalled. Timing becomes more critical the higher the transmission rates. If no characters are received (timeout), a zero is stored every 100 ms.

Example:

```
10 OPENI #1, "com1:"
20 INPUT #1, A$
```

The entry described above is for line-oriented text as characters are accepted until reception of CR. However, if the number of characters is known, the INPUT\$( ) function ensures that any character and almost any number of characters can be received.

Example:

```
10 OPENI #1, "com2:"
20 A$=INPUT$( 100, #1)
```

Precisely 100 characters are read in. If less characters are received, the device waits 100 ms (specified timeout) for every expected character (and enters zero).

To wait for the start of the transmission, a character can be entered in a loop until the character is no longer zero.

Example:

```
20 REPEAT
30 A$=INPUT( 1, #1)
40 UNTIL ASC( A$) > 0
40 INPUT #1, B$
50 B$=A$+B$
```

**3.16.4.10 UPL-Specific Error Messages From BASIC**

- ERROR 83: 'Instrument command allowed in this context'  
The command is not allowed in this instrument state and depends on other settings.  
( 'Execution error' with IEC/IEEE-bus control)
- ERROR 84: 'Instrument param not within valid range'  
The value of the command parameter is illegal.
- ERROR 85: 'Instrument unit not allowed in this context'  
The indicated unit is not allowed (in this state).
- ERROR 87: 'Instrument option not installed'  
The option required for this command is not fitted.
- ERROR 88: 'Instrument ??? user error'  
A user-correctable error has occurred during command execution (eg file not found).
- ERROR 89: 'Instrument ??? system error'  
An error has occurred in the MS-DOS or UPL software during command execution.
- ERROR 90: 'Instrument invalid header string'  
The actual command was not recognized (possibly because of a notation error).
- ERROR 91: 'Instrument invalid parameter string'  
The parameter of the command (string) is invalid.
- ERROR 92: 'Instrument invalid unit string'  
The unit of the command (string) is invalid.

### 3.16.4.11 UPL/BASIC Memory Management

The user need not be familiar with all the details, as the user automatically receives the CONFIG.SYS to be used and associated batch files with the program UPLSET described in section 3.16.3.

Since the memory available to MS-DOS programs is limited, the overlay technique is used in the UPL program. Furthermore, BASIC requires memory for the user program and its data (variables). These memory areas are assigned the parameters

- bp<n> for the program memory and
- bd<n> for the data memory.

Example:

```
upl_ui -bp16 -bd8
```

reserves 16k main memory for the program and 8k for the data, BASIC itself needing about 3k for its own management.

The minimum values are about 8k program and 4k data. BASIC can manage a maximum of 64k. However, with a size of about 2 times 32 k, the overlay memory for the UPL program decreases, reducing the program speed. More details cannot be given, since the available total memory, which may be occupied by resident programs and device drivers, may be very different.

The memory management of the UPL program is to be briefly explained in the following so that an experienced user can optimize his own configuration. The program and data memory used for BASIC is first reserved in the UMB area. If this is not possible (because the line DOS=HIGH,UMB is missing in the CONFIG.SYS, or too many other programs have been loaded into this area by LOADHIGH or DEVICEHIGH), the space in the conventional memory (below 640k) is used. If the remaining memory for the UPL program thus becomes too small, no memory is reserved for BASIC at all. The attempt to switch to BASIC then produces the error message "not enough memory for BASIC".

In memory models 64k plus 32k (or 32k plus 64k) also the device drivers are loaded into the UMB area. With 64k plus 64k the upper memory is completely full and the device drivers have to be stored in the conventional memory.

If space is to be used in the conventional memory, the size of the overlay memory is reduced. The UPL program may be restricted in its speed from a certain size onwards, which also depends on the memory required by other resident programs.

When executing BASIC, other instruments can also be controlled via the IEC/IEEE-bus interface. In this case, the UPL is the system controller via BASIC, i.e. it can no longer be remote-controlled by an external controller. The parser program UPL\_IEC.EXE is no longer needed and must not be loaded any more when starting the UPL. Instead, BASIC requires the following device drivers:

STRINX.SYS	as BASIC editor
IECX.SYS	as IEC/IEEE-bus controller
GRAPHX.SYS	for the BASIC commands for graphics output
BEEPX.SYS	for audio outputs.

### 3.17 Remote Control via RS-232 Interface

As from UPL version 1.0 onwards, when an option UPL-B4 is purchased, remote control is not only possible via the IEC/IEEE bus but also via the RS-232 interface at the COM2 port at the rear of the instrument.

#### 3.17.1 Preparation for Use

To activate the COM2 interface of the UPL for remote control select

Remote via	COM2
------------	------

in the options panel.

To allow communication between controller and UPL via the RS-232 interface, the parameters of the two COM2 interfaces must be matched. The UPL parameters can be set with

COM2	PARAMETER	-----
Baud Rate	2400	... 56000
Parity	EVEN   ODD   NONE	
Data Bits	7   8	
Stop Bits	1   2	
Handshake	XON/XOFF   RTS/CTS	

in the options panel.

The meaning of the parameters can be seen in section 2.15.1 IEC/IEEE-bus Address

Use a zero-modem cable with the following assignment for interconnecting controller and UPL (2 x 9-pin female connector, R&S Order No. 1050.0346). This cable is suitable for RTS/CTS and XON/XOFF handshake.

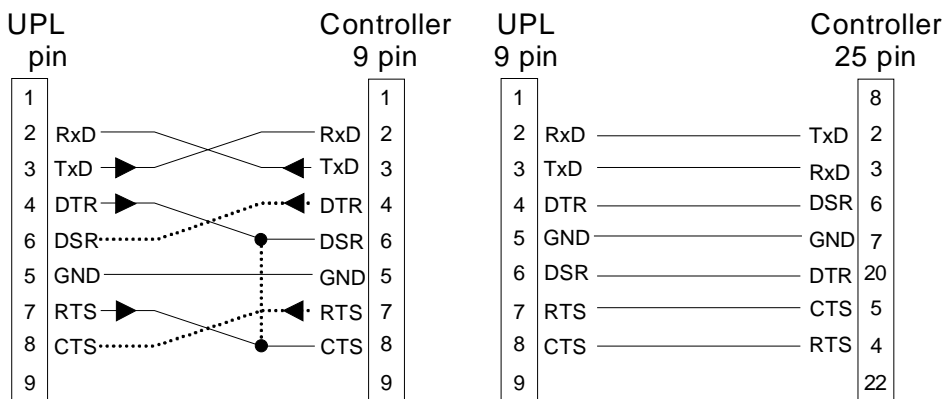

Fig. 3-18 Universal RS-232 cable, suitable for RTS/CTS and XON/XOFF handshake

**RTS (request to send)** is an output of the UPL which is set to TRUE (+12V) upon UPL switch-on. With **handshake = RTS/CTS** selected, UPL sets RTS to FALSE (-12V) when the UPL buffer is full during a data transmission from the controller to the UPL. In this case the controller must stop data transmission immediately until the contents of the data buffer have been processed by the UPL and RTS has been reset to TRUE. Normally, the RTS line of the UPL is connected to the CTS line of the controller. With **handshake = XON/XOFF**, RTS is not served by the UPL and remains set to TRUE.



**DTR (data terminal ready)** is an output of the UPL which is set to TRUE (+12V) upon UPL switch-on and which does not change. If the RS-232 interface of the controller requires the DSR (data set ready) input to be set to TRUE, it is best to connect DTR of the UPL to DSR of the controller. With **Handshake = XON/XOFF** selected, RTS of UPL is always TRUE. Thus DSR and CTS of the controller could be linked by means of a jumper on the PC connector (see dotted line).

**CTS (clear to send)** of the UPL is an input. If the UPL wishes to send data to the controller or plotter with **handshake = RTS/CTS** selected, it first checks whether the addressed device is ready to receive data. State-of-the-art devices normally signal their readiness to receive via the RTS output (older devices often via the DTR output). If the CTS input of the UPL is TRUE (+12V), UPL starts data transmission. If the data buffer of the addressed device is full, the RTS output is reset and the CTS input of the UPL is set to FALSE (-12V). As soon as the data buffer of the addressed device is empty, the device resets the RTS output and thus the CTS input of the UPL to TRUE and UPL continues data transmission. With **handshake = XON/XOFF** selected, the CTS input of the UPL is irrelevant and the connection CTS - - - RTS (dash-point line) is not required.

**DSR (data set ready)** of the UPL is an input which is not evaluated however. The line DSR - · · - · DTR (dash-dot-dot line) is not required.

### 3.17.2 Switchover to Remote Control

After power-up, the UPL is always in the manual operating mode (LOCAL state) and can be controlled from the front panel or a keyboard. Control is switched to REMOTE as soon as a signal is identified at the RS-232 interface via COM2 in the remote control mode. During remote control the front-panel keys are disabled. The UPL remains in the REMOTE control mode.

### 3.17.3 Return to Manual Operation

UPL remains in the REMOTE control mode until switched to manual mode by means of the LOCAL key on the front panel or command SYSTem:GTL. A change from manual to remote control and vice versa does not change the instrument settings.

### 3.17.4 First Steps (Readout of Measurement Results)

A simple test of the RS-232 interface can first be performed with DOS commands from the PC.  
Example:

- Connect the COM1 interface of the PC and the COM2 interface of the UPL using the zero-modem cable. If the COM1 interface of the PC is assigned to a mouse, the mouse may be connected to the COM2 interface of the PC using the adapter cable (9 → 25-way) normally supplied with the mouse.
- Set UPL in the OPTIONS panel to remote control using the RS-232 interface. The standard parameters of the COM2 interface, 9600 baud, even parity, 7 data bits, 1 stop bit, are set in the UPL. This standard setting is made when the BACKSPACE key is pressed during UPL switch-on (loading DEFAULT setup), *UPL -d* is entered at the DOS level and after (new) installation of an UPL software. On switching the UPL off and on or upon loading a setup, the "Remote via" settings and the parameters of the serial COM2 interface remain unchanged.

Remote via	COM2
:	
:	
PARAMETER	-----
Baud Rate	9600
Parity	EVEN
Data Bits	7
Stop Bits	1
Handshake	RTS/CTS

- Adapt the COM1 interface of the PC to the COM2 interface of the UPL with DOS command *mode*:  
*mode com1*  
*:9600,e,7,1*
- Create an ASCII file with the name COMOUT.TXT at the PC using the DOS editor, which comprises the characters **"\*RST"** (set UPL to default setting).
- Send the contents of file COMOUT.TXT to the COM1 interface:
- *copy COMOUT.TXT com1*:

UPL goes to the REMOTE mode and to the default setting.

- Although the described method allows control of the UPL, data cannot be read out as the copy command of DOS requires received characters to be terminated with the delimiter CTRL Z (1A hex) and UPL terminates its responses with a Line Feed (0A hex).

The following program examples demonstrate UPL control and read-out of measurement results via the RS-232 interface. For the three examples the RS-232 interface parameter should be set as described in section 3.17.4.

Because of the default setting with **"\*RST"** (see Appendix A **UPL Default Setup**), the UPL generator produces a 1-kHz sinewave signal with a level of 0.5 V.

Command **"INP:TYPE GEN2"** internally links generator channel 2 and analyzer channel 1 so that no cabling of outputs and inputs is required. The UPL analyzer performs 10 RMS measurements and the results are displayed in the result field and on the controller screen.

**Note:**

A measurement result must be triggered before it can be displayed on the screen (**"INIT:CONT OFF;\*WAI"**). After triggering, a settled result is available which can be queried, (**"SENS1:DATA1?"**), read in (**comin**) and displayed on the screen of the controller. (**PRINT . . .**).

### 3.17.4.1 Readout of Measurement Results in QuickBASIC

Enter the following program listing in Microsoft QuickBASIC (most of the PCs will use **QuickBASIC** under MS-DOS on the PC) and start with Shift-F5:

In QuickBASIC a maximum transfer rate of 19200 baud can be set (**OPEN**  
**"COM1:19200,E,7,1,RB100"** FOR RANDOM AS #1).

Since QuickBASIC does not support the hardware handshake RTS/CTS the size of the communication buffer (**RB value** in byte) had to be adapted to the expected data quantity and the controller speed: the slower the controller the larger the data quantity and the higher the RB value.

Every output string must be terminated with an LF (line feed) so that UPL is able identify the end of the command. In this program example the line feed is added generally to the output string in the **Comout** output routine (**PRINT #1, A\$; CHR\$(10)**).

```

*****
* Triggering and output of 10 measurement results *
*****
DECLARE FUNCTION Comin$ ( )
DECLARE SUB Comout (A$)

OPEN "COM1:9600,E,7,1,RB100" FOR RANDOM AS #1: ' Parameter of COM1
'The size of the communication buffer (RB value in bytes) has to be
'adapted to the expected data quantity: The slower the controller the larger
the data quantity and the higher the RB value.
'For a single measurement result a few bytes will be sufficient,
'for a block data transfer of 1024 Y values of an FFT in ASCII
'format with a total length of more than 12000 bytes approx. RB5000
is required.
Comout ("*RST;*WAI"): ' Loads default setup
Comout ("INP:TYPE GEN2"): 'Connects analyzer input to generator output
FOR I = 1 TO 10
  Comout ("INIT:CONT OFF;*WAI"): ' Triggers and waits for result
  Comout ("SENS1:DATA1?"): ' Queries measurement result of channel 1
  PRINT Comin$: ' Reads out and outputs measurement result
NEXT I
CLOSE
END

FUNCTION Comin$
'*** Reading the response string of UPL at COM1 ***
' UPL terminates each output string with NL (CHR$(10)).
' Characters are read from the COM1 interface until NL is received.
X$ = ""
NZ: Z$ = INPUT$(1, 1): ' Reads single characters from COM1
IF Z$ <> CHR$(10) THEN X$ = X$ + Z$: GOTO NZ: ' Next character
Comin$ = X$: ' Returns complete string
END FUNCTION

SUB Comout (A$) STATIC
'*** Output of ASCII string at the COM1 interface ***
PRINT #1, A$; CHR$(10): 'Each string must be terminated with NL (CHR$(10)).
END SUB

```

### 3.17.4.2 Readout of Measurement Results in R&S BASIC

Enter the following program listing in R&S BASIC and start with F2 (RUN).

When R&S BASIC is already installed on the controller, the COMX.SYS device driver allows the maximum UPL transmission rate of 56000 baud (OPENI# 1, "com1:56000,e,7,1,2000") to be used.

Every output string must be terminated with LF so that the UPL is able to identify the end of a command (eg "INP:TYPE GEN2"+CHR\$(10);).

```

10 *****
30 * Triggering and output of 10 measurement results *
40 *****
50 OPENO# 2,"com1:"
60 OPENI# 1,"com1:9600,e,7,1,2000": ' Set COM1 parameter
70 PRINT# 2,"*RST"+CHR$(10);: ' Sets default setup with internal connection
80 PRINT# 2,"INP:TYPE GEN2"+CHR$(10);: ' between generator and analyzer
90 FOR I=1 TO 10: ' Outputs 10 individually triggered measurement results
100 PRINT# 2,"INIT;*WAI"+CHR$(10);: ' Triggers measurement result
110 PRINT# 2,"SENS:DATA?" +CHR$(10);: ' Selects measurement result
120 GOSUB Comin: ' Reads out measurement result

```

```

130 PRINT Instr$: '                               Outputs measurement result
140 NEXT I
150 END
160 '
170 '***** Reading in the UPL response *****'
180 Comin:
190 C$="": Instr$=""
200 Nexchar:
210 C$=INPUT$(1,#1): '                             Reads individual characters
220 IF C$=CHR$(10) THEN RETURN : 'Terminates reading when an LF is received
230 Instr$=Instr$+C$: GOTO Nexchar: 'Links individual characters to a string

```

### 3.17.4.3 Readout of Measurement Results in Borland-C 3.0

Enter the following program listing in Borland-C 3.0 and start with CTRL-F9 (RUN).

In Borland-C 3.0 a maximum transmission rate of 9600 baud can be set.

Each output string must be terminated with a line feed so that UPL can identify the command end (eg "INP:TYPE GEN2\n").

```

#include <stdlib.h>
#include <stdio.h>
#include <string.h>
#include <bios.h>
#include <dos.h>
#include <conio.h>

/*****
/*                               Declarations                               */
*****/

#define COM_1 0
#define COM_2 1
#define SETTINGS (_COM_9600 | _COM_CHR7 | _COM_STOP1 | _COM_EVENPARITY)

/*The following settings can be made in bios.h: */
// _COM_CHR7      0x02      /* 7 data bits */
// _COM_CHR8      0x03      /* 8 data bits */
// _COM_STOP1     0x00      /* 1 stop bit */
// _COM_STOP2     0x04      /* 2 stop bits */
// _COM_NOPARITY  0x00      /* no parity */
// _COM_EVENPARITY 0x18      /* even parity */
// _COM_ODDPARITY 0x08      /* odd parity */
// _COM_110       0x00      /* 110 baud */
// _COM_150       0x20      /* 150 baud */
// _COM_300       0x40      /* 300 baud */
// _COM_600       0x60      /* 600 baud */
// _COM_1200      0x80      /* 1200 baud */
// _COM_2400      0xa0      /* 2400 baud */
// _COM_4800      0xc0      /* 4800 baud */
// _COM_9600      0xe0      /* 9600 baud */

```

```

/*****
/* Initialization of interface */
/*****
void init_com(int port)
{
    _bios_serialcom(_COM_INIT, port, SETTINGS);}

/*****
/* Output of character */
/*****
void outp_char(int port,char c)
{
    _bios_serialcom(_COM_SEND, port, c);
}

/*****
/* Reading a character */
/*****
int inp_char(int port,char *to_rec)
{
    unsigned int status;

    while (1)
    { /* Read until a character of error-free status is received */
        status = (_bios_serialcom(_COM_RECEIVE, port, 0) & 0x9fff);
        if ((status & 0x9f00) == 0)
        {
            *to_rec = (char)status;
            return (0);
        }
    }
}

/*****
/* Output of string */
/*****
void comout(int port, char *strptr)
{
    while (*strptr != '\0')
        outp_char(port,*strptr++);
}

/*****
/* Read string until a line feed is received */
/*****
void comin (int port, char *recptr)
{
    int idx = 0;
    char c = 0;

    while (1)
    {
        inp_char (port,&c);
        recptr[idx] = c;
        if (c == '\n') // Abort when LF is received
            break;
        idx++;
    }
    recptr[idx] = '\0'; // Overwrite NL with '\0'
}

```

```

/***** Main program *****/
/* Triggering and output of 10 measurement results */
/*****
int main ()
{
char recstring[100];
int i;

init_com(COM_1);

comout (COM_1, "*RST;*WAI\n");
comout (COM_1, "INP:TYPE GEN2\n");

for (i = 1; i <= 10; i++)
{
comout (COM_1, "INIT;*WAI\n");
comout (COM_1, "SENS:DATA?\n");
comin (COM_1, recstring);
printf ("%s\n",recstring);
}
printf ("Continue: ");
getch ();
return (1);
}

```

### 3.17.5 Binary Data via RS232 Interface

#### First steps

To obtain the programs RS232\_BT.EXE and RS232\_BT.BAS, which are required for a transmission of binary data via RS232 interface, proceed as described under 3.15.20 Binary Data via IEC/IEEE-Bus Interface.

#### Transmitting a File to UPL via RS232 Interface

RS232\_BT.BAS is written in the programming language QuickBASIC from Microsoft, which are under MS-DOS on most PCs.

The source file RS232\_BT.BAS runs under QuickBASIC and can be adapted to the user's needs whenever necessary.

For transmitting binary data via RS232\_BT.EXE, the following settings must be made in the OPTIONS panel of UPL:

Remote via	COM2	
COM2 PARAMETER	-----	
Baud Rate	19200	(max. permissible baudrate for QuickBASIC)
Parity	NONE	(required for binary transmission)
Data Bits	8	(required for binary transmission)
Stop Bits	1	
Handshake	RTS/CTS	

When transmitting binary data via the RS232 interface, the XON/XOFF handshake must **not** be set in the OPTIONS panel of UPL, since XON/XOFF functions by means of exchanging binary characters, which may affect characters in the binary data stream.

As an RS232 cable connecting UPL and the control PC, a modem-bypass cable with R&S order number 1050.0346 should be used, or a cable with a pin assignment as described in 3.17.1 Preparation for Use, Fig. 3-42.

After RS232\_BT has been called, the program requests the following:

- Selection of the desired interface COM1 or COM2 at the controller as well as the desired baud rate (make sure the baud rate selected in UPL is used). The program now attempts to contact the UPL. If this is successfully done, UPL measurements are halted to attain maximum transmission speed.
- Path and file name of the file to be transmitted are polled as well as the name of the file to be generated with this content in the UPL working directory.
- The program now generates a temporary file with the name TEMP.OUT, which contains the RS232 command required for UPL and the data set to be transmitted.
- TEMP.OUT is now transmitted to UPL. As the transmission takes considerably more time than via IEC/IEEE bus, the program has a progress bar. The file TEMP.OUT is retained in the controller also after the transmission is completed so that it can be viewed by means of an editor with binary capability.
- Following the transmission, signatures are generated (see MD5 signature technique) using the original file on the controller and the file stored in UPL. If these two files have the same signatures, it may be assumed with great certainty that the file are absolutely identical and no transmission errors have occurred.

### MD5 Signature Method

To check whether a file was transferred error-free from the process controller to the UPL, the MD5 signature method can be used, see 3.15.20 Binary Data via IEC/IEEE-Bus Interface. UPMD5.EXE can conveniently be called up as "child process" (SHELL) from its RS232 control program in order to compute the signature with the signature of the file transmitted to the UPL.

```
Example in QuickBASIC see source code RS232_BT.BAS lines 53 and 54
shellcmd$ = "UPMD5.EXE " + hostfina$ + "> " + hostcheckfina$
SHELL (shellcmd$)
```

To fetch the signature of a file stored on the UPL under RS232 control, the command "MMEMory:CHECK? 'filename'" is to be sent to the UPL.

### 3.17.6 Differences to Remote Control via IEC/IEEE Bus

- A command line sent to the UPL must always be terminated with <New Line> (ASCII code 10, decimal). Since the character <Carriage Return> (ASCII code 13, decimal) before the delimiter is a filler without significance, the combination <Carriage Return> <New Line> is also permissible.
- **ASCII strings** sent by the UPL as a response to the controller via the RS-232 interface are always terminated with <New Line> (ASCII code 10, decimal).  
**Block data in binary form** are sent to the controller via the RS-232 interface without delimiter. The number of bytes can be seen from the digits sent ahead of the block data:

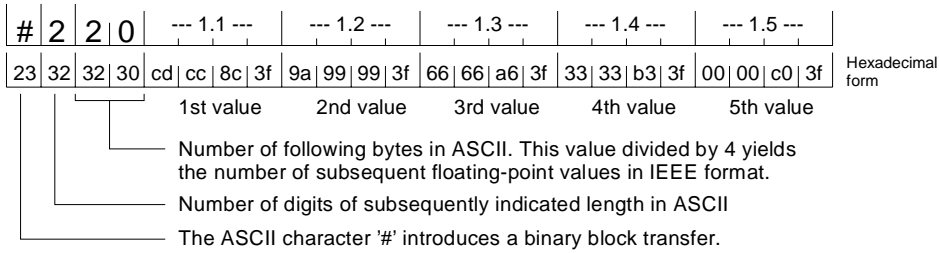

Program examples 3.17.4.1 Readout of Measurement Results in QuickBASIC and 3.17.4.3 Readout of Measurement Results in Borland-C 3.0 illustrate the readout of binary block data.

- With remote control via RS-232 all the common commands related to SRQ control are not useful. This can be seen in the table under 3.9 Common Commands . An exception is the \*OPC command. The main task of this command is to trigger an SRQ when a measurement result is available, but in the case of RS-232 control, it may be used to wait in a loop for a measurement result by querying bit d0 of the Event Status Register, see 3.17.4.1 Readout of Measurement Results in QuickBASIC.
- Common commands (3.13.1) and addressed commands (3.13.2) are not used in RS-232 control.
- With RS-232 remote control, an SRQ procedure cannot be programmed, ie the control program is not able to carry out another task while it waits for measurement results or error messages from the UPL. Error queue or status register must be queried cyclically in the control program.
- Since an SRQ routine is not available, there is no need to determine the sender or the source of an SRQ in a serial or parallel poll.
- Line messages like REN, GET, DCL, etc are not possible.
- The line message EOI denoting the end of a binary block cannot be used. If binary data are to be received nevertheless, the expected block length must be used instead. Remember that data bits = 8 and parity = NONE must be set for the receipt of binary data.
- All registers and commands of the status reporting system not referring to SRQ generation may be used:

*STB?	not usable
*SRE	not usable
*PRE	not usable
*IST?	not usable
*ESR?	<b>usable</b>
*ESE	not usable
STATus:OPERation?	<b>usable</b>
STATus:QUESTionable?	<b>usable</b>
STATus:XQUESTionable?	<b>usable</b>
SYSTem:ERRor?	<b>usable</b>





## 4 Maintenance and Troubleshooting

### 4.1 Maintenance

#### 4.1.1 Mechanical Maintenance

- Clean the front panel and keys using a soft, damp cloth soaked with a liquid detergent, if required.
- Cleaning the LC display: do not use any acid solutions or abrasive cleaners (otherwise the anti-reflecting coat is damaged)! We recommend that standard cleaners as are used for optical devices such as glasses, objectives and the like or water mixed with some rinsing liquid be used for cleaning.

#### 4.1.2 Electrical Maintenance

The UPL requires no electrical maintenance.

### 4.2 Function Test

Upon switch-on of the UPL the following self-tests are performed:

- Self-test on the computer. On the detection of any error the AT warning tone codes (see Table 4-1) will be audible. The system start is aborted, the UPL cannot be operated. With an external keyboard connected, the subsequent memory test can be aborted by pressing the "ESC" key.

Table 4-1 AT warning tone codes

AT-warning tone	Meaning
1	DRAM refresh failure
2	Parity Circuit failure
3	Base 64kB RAM failure
4	System Timer failure
5	Processor Failure
6	Keyboard Controller-Gate A20 error
7	Virtual Mode Exception Error
8	Display Memory R/W Test Failure *)
9	ROM-BIOS CheckSum Failure

\*) non-fatal error

- Self-test on all boards of the measurement hardware including all options installed (recognized by the UPL itself). The self-test is carried out while the switch-on picture is being displayed on the screen and also during normal measurement procedures - however to a limited extent. On the detection of an error a message is displayed, which specifies the type of error, the name of the defective board and, if possible, a hint for the user how to eliminate the defect.

## 4.3 Troubleshooting

Error messages displayed after the self-tests or during a measurement usually contain a hint as to the cause of trouble and its elimination (see Section 2.3.6 Error Messages). If the cause is a defective board, it should be replaced (see 4.4 Replacing the Boards). For more details on the theory of operation of the measurement hardware boards and instructions on further fault locating, please refer to the Service Manual (order designation 1030.7551.24).

### 4.3.1 BIOS-SETUP

It depends on the UPL model and the time of delivery, which controller boards and hard disk drives are supplied with the instrument. Thus, the operating menu for setting the SETUP parameters and the parameters, too, differ accordingly.

Operation of the setup menu is not explained since it may be obtained from the operator guidance lines.

#### Calling the SETUP menu

- Switch off the instrument, connect external keyboard.
- Switch on, press "DEL" key (or ENTF key with German keypad) and hold until the SETUP menu is displayed.
- Select menu item for setting the setup (e.g., "RUN CMOS SETUP", "STANDARD-SETUP", ...)
- Set according to the board and hard disk installed. The parameters to be entered are listed in the paragraphs below.

**Note:** *The setup menus assume an English keypad to be connected. With a German keypad, Y and Z have been exchanged compared to the English one (notice with acknowledging requests).*

**Caution:** *If the SETUP is not set correctly, this may lead to malfunction of the instrument! In this case, switch off the instrument, press "INS" key (or "Einfg" key with German keypad) and hold, switch on the instrument and release key with start of the memory test. The SETUP is thus reset to default values.*

#### SETUP for UPL 05 with 80486 DX4/75 Board

Table 4-2 Standard Setup (UPL05)

Date/Time	Current date /time
Floppy A	1,44 MB
Floppy B, Slave Disk	not installed
Hard Disk	use DETECT MASTER (s. u.)

The parameters for the hard disk need not be entered. The setup program determines the parameters when calling the "DETECT MASTER" function in the UTILITY menu.

Table 4-3 Advanced Setup (UPL 05)

Typematic Rate	30
System Keyboard	Absent
Primary Display	VGA/EGA
Above 1MB Memory Test	Enabled
Memory Test Tick Sound	Enabled
Hit "DEL" Message Display	Enabled
Extended BIOS RAM Area	0:300
Halt for "F1" if any Error	Disabled
System Boot Up Num Lock	On
Numeric Processor Test	Enabled
Floppy Drive Seek At Boot	Disabled
System Boot Up Sequence	C:, A:
Password Checking	Setup
Video Shadow C000, 32K	Enabled
Shadow C800, 32K	Enabled
Shadow D000, 32K	Disabled
Shadow D800, 32K	Disabled
Shadow E000, 32K	Disabled
Shadow E800, 32K	Disabled
Internal Cache	Enabled
Internal Cache Write Mode	Wrt-Thru
External Cache	Enabled
Video ROM Cache C000, 32k	Enabled
System ROM Cache F000, 64k	Enabled
Non Cachable Area #1 Size	Disabled
Non Cachable Area #1 Base	Disabled
Non Cachable Area #1 Type	DRAM
Non Cachable Area #2 Size	Disabled
Non Cachable Area #2 Size	Disabled
Non Cachable Area #2 Type	DRAM
IDE Block Mode	Disabled
Primary Master IDE LBA Mode	Disabled
Primary Slave IDE LBA Mode	Disabled
Secondary IDE Drives Preset	None
Secondary Master IDE LBA Mode	Disabled
Secondary Slave IDE LBA Mode	Disabled

Table 4-4 Chipset Setup (UPL 05)

System Auto Configuration	Enabled
Bus Frequency	7.159 MHz
System DRAM Speed	Fastest
DRAM Write Cycle Pulse Time	1T
DRAM Write Cycle Wait State	1 ws
Cache Burst Read Cycle Time	1T
Cache Write Cycle Time	2T
16 Bit 0 Wait State Override	Disabled
16 Bit I/O Read Cmd Delay	Disabled
16 Bit Read Cyc Reduction	Disabled
DRAM Burst Write Mode	Disabled
Slow Refresh	Disabled
Hidden Refresh	Enabled
Local Bus Latch Timing	T3
Local Bus Ready (LRDY *)	Sync.
16 Bit I/O Recovery Time	5 Clks
16 Bit Memory, I/O Wait State	1 ws
8 Bit I/O Recovery Time	16 Clks
8 Bit Memory, I/O Wait State	4 ws

**Note on memory expansion, if fitted:**

The SIMM modules used have 72 contacts (PS2-SIMMs). 1Mx36 or 4Mx36 modules with an access time of 70 ns may be used.

**SETUP for UPL 02 with 80386/40-Board**

Table 4-5 Standard Setup (UPL 02)

Floppy Drive A	1.44 MB
System Keyboard	Not Installed
Harddisk C	use AUTODETECT HARDDISK (s.u.)
Harddisk D	Not installed
Primary Display	VGA/EGA

The parameters for the hard disk need not be entered. The setup program determines the parameters when calling the AUTO DETECT HARDDISK function.

Table 4-6 Advanced Setup (UPL 02)

Above 1MB Memory Test	Enabled
Memory Test Tick Sound	Disabled
Hard Disk Type 47 Area	0:300
System Boot Up Num Lock	Off
Floppy Drive Seek At Boot	Disabled
System Boot Up Sequence	C:, A:
External Cache	Enabled
Internal Cache	Disabled
Password Checking	Setup
IDE Block Mode	Disabled
IDE Standby Mode	Disabled
Chip Away Virus	Disabled

Table 4-7 Chipset Setup (UPL 02)

Cache Read Option	3--1--1--1
Cache Write Option	1 WS
DRAM Waitstates	1 WS
Keyboard Clock Select	9.5 MHz
AT Clock	CPUCLK/5
16 Bit I/O Recovery Time	5/3 BCLK
CoProcessor Ready	No Delay
Non Cachable Area \#1 Size	Disabled
Non Cachable Area \#1 Base	Disabled
Non Cachable Area \#1 Type	DRAM
Non Cachable Area \#2 Size	Disabled
Non Cachable Area \#2 Size	Disabled
Non Cachable Area \#2 Type	DRAM
Memory Remapping	Enabled
Alle Shadow Optionen	Enabled

- Store setup

**Note on memory expansion, if fitted :**

The SIMM modules used have 72 contacts (PS2-SIMMs). 1Mx36 or 4Mx36 modules with an access time of 70 ns may be used..

**4.3.2 Others**

**Fault symptom:**

- After switch-on, the UPL is not in the same state as it was before switch-off. The last entries have been omitted.
- The following error message is displayed:  
"CMOS CHECKSUM ERROR. "

**Cause:**

Battery of test hardware discharged, since the instrument has long since been switched on.

The UPL contains a CMOS memory which stores all settings of all active panels and the data of the recorded traces. The settings of the other panels and the previous states of the active panels is saved on the hard disk, in addition. These data are still available after a failure of the battery. A capacitor bank is used as backup for the CMOS RAM when the instrument is switched off.

**Error recovery:**

Have the instrument switched on for at least four hours. The battery is then recharged and the settings are retained after switch-off.

**Fault symptom:**

The UPL does not respond in a sensible way or not at all on key depressions or IEC bus commands.

**Cause:**

The combination of previous settings resulted in an inadvertent program run causing the software to "crash".

**Error recovery:**

Restart the UPL!

Depending on the desired instrument setup take the following steps:

Restart the UPL with the instrument setup most recently stored in the CMOS-RAM.

This setup may be correct despite the faulty response of the UPL. To avoid having to enter again the settings most recently made, have a try at starting the UPL with this setup.

- Turn power switch off and on. (No further action possible).

In case the procedure stated above fails, restart the UPL with its default setup.

- Connect external keyboard (see 1.1.6 Connecting an External Keyboard).
- Turn power switch off and on.
- When the UPL switch-on logo is displayed, abort the UPL program by pressing ESC and enter the DOS operating system level, where you can restart the UPL with its default setting by entering the command

UPL -d and confirm by pressing ENTER

The setup "DEFAULT.SET" in the "c:\upl\setup" directory supplied together with the UPL is loaded.

LOAD INSTRUMENT STATE in the FILE panel allows the loading of a setup which was stored by the user (see 2.9.1.1).

Further notes on software faults can be looked up in Section 2.3.6 Error Messages.

## A UPL Default Setup

The default setup of the UPL is triggered by means of the settings below:

Manual setting in the FILE panel:	IEC/IEEE bus:
LOAD INSTRUMENT STATE Mode DEF SETUP	*RST

A precondition for the validity of basic settings is that the parameter link is switched off (see **2.15.8 Transfer of Parameters** (Parameter Link Function)).

### A.1 Default Settings of Generator

#### INSTRUMENT — ANALOG

- Channel(s) 2 = 1

*For setting GENERATOR → ANALOG (default setting) the following applies:*

- Output UNBAL
- Max Volt 12.000 V
- Ref Freq 1000.0 Hz
- Ref Volt 1.0000 V

*For setting GENERATOR → DIGITAL the following applies:*

- Src Mode AUDIO DATA Further selections: JITTER ONLY | PHASE | COMMON ONLY
- PhaseToRef 0.0000 %FRM with Src Mode PHASE only
- Channel(s) 2 = 1 not with Src Mode COMMON ONLY
- Unbal Out AUDIO OUT
- Cabel Sim OFF
- Sync To AUDIO IN
- Sample Frq 48 kHz
- Sync Out GEN CLK
- Type WORD CLK
- Ref Out REF GEN
- Data ALL ZERO
- Audio Bits 20 with Src Mode AUDIO DATA | PHASE only
- Unbal Vpp 1.0000 V
- Bal Vpp 0.0000 V
- Max Volt 1.0000 FS with Src Mode AUDIO DATA | PHASE only
- Ref Freq 1000.0 Hz

- PROTOCOL STATIC
- Ch Stat. L ZERO
- Ch Stat. R EQUAL L

- AUX GEN OFF with SRC Mode AUDIO DATA | PHASE only

*For setting AUX GEN → ANALOG OUT the following applies:*

- Channel(s) 2 = 1
- Output UNBAL
- SWEEP CTRL OFF
- Anlg Freq 1000.0 Hz
- Anlg Ampl 0.1000 V

The auxiliary generator (AUX GEN) has its own sweep system designed similar to the sweep system of the function generator. The function for a 2-dimensional sweep (Z axis), ie simultaneous frequency and level sweep, is not implemented. The default setting of commands is largely identical to the SWEEP CTRL points described for FUNCTION SINE in the section "Functions common to all generators".



*For setting AUX GEN → COMMON MODE the following applies:*

- SWEEP CTRL OFF
- Comm Freq 1000.0 Hz
- Comm Ampl 0.1000 V

*For setting AUX GEN → JITTER the following applies:*

- SWEEP CTRL OFF
- Jitt Freq 1000.0 Hz
- Jitt Ampl 0.1000 UI

**Functions common to all generators**

**FUNCTION SINE**

- Frq Offset OFF
- Low Dist ON ANALOG generator. If low-dist. generator option not installed: OFF
- DC Offset OFF with ON: 0.0000 FS or: 0.0000 V
- Dither OFF with DIGITAL generator

*For setting Dither ON the following applies:*

- PDF 0.0001 FS with DIGITAL generator
- Equalizer GAUSS with DIGITAL generator
- Equal.File OFF
- Equal.File R&S\_EXAM.VEQ with equalizer ON
- SWEEP CTRL OFF
- FREQUENCY 1000.0 Hz
- VOLTAGE 0.5000 V[FS]

*For setting SWEEP CTRL → AUTO SWEEP or MANU SWEEP the following applies:*

- Next Step ANLR SYNC with AUTO SWEEP only
- X Axis FREQ
- Z Axis OFF

*With X or Z axis → FREQ selected*

- FREQUENCY
- Spacing LOG POINT
  - Start 20000 Hz
  - Stop 20.000 Hz
  - Points 30
  - VOLTAGE 0.5000 V [FS]

*With X or Z axis → VOLT selected*

- FREQUENCY 20000 Hz
  - Equalizer OFF
  - Equal.File R&S\_EXAM.VEQ with equalizer ON
- VOLTAGE
- Spacing LIN POINTS
  - Start 0.0100 V[FS]
  - Stop 0.5000 V[FS]
  - Points 30

For setting SWEEP CTRL → AUTO LIST or MANU LIST the following applies:

- Next Step ANLR SYNC with AUTO LIST only
- X Axis FREQ
- Z Axis OFF

With X or Z axis → FREQ selected

- FREQ.FILE R&S\_EXAM.SPF with X or Z axis → FREQ selected

With X or Z axis → VOLT selected

- FREQUENCY 1000.0 Hz
- VOLT.FILE R&S\_EXAM.SPV

**FUNCTION STEREO SINE** with INSTRUMENT DIGITAL only

- Frq Offset OFF
- DC Offset OFF with ON: 0.0000 FS
- Dither OFF

For setting Dither ON the following applies

- PDF 0.0001 FS
- PDF GAUSS
- Equalizer OFF
- Equal.File R&S\_EXAM.VEQ with Equalizer ON
- Freq Mode FREQ&PHASE
- Volt Mode VOLT&RATIO
- SWEEP CTRL OFF
- FREQUENCY 1000.0 Hz
- Phas Ch2:1 0.0000 °
- VOLT CH1 0.5000 FS
- Volt Ch2:1 4.0000 :1

For setting Freq Mode → FREQ CH1&2

- Freq Ch1 1000.0 Hz
- Freq Ch2 1000.0 Hz

For setting Volt Mode → VOLT CH1&2

- Volt Ch1 0.5000 FS
- Volt Ch2 0.5000 FS

For setting von SWEEP CTRL → AUTO SWEEP or MANU SWEEP the following applies:

- Next Step ANLR SYNC with AUTO SWEEP only
- X Axis FREQ
- Z Axis OFF

For setting Freq Mode → FREQ&PHASE

with X- or Z-Axis → FREQ selected

- FREQUENCY
- Spacing LOG POINT
  - Start 20000 Hz
  - Stop 20.000 Hz
  - Points 30
  - Phas Ch2:1 0.0000 °

For setting Freq Mode → FREQ CH1&2

with X- or Z-Axis → FREQ selected

- FREQUENCY
- Spacing LOG POINT
  - Start 20000 Hz
  - Stop 20.000 Hz
  - Points 30
  - Freq Ch2 1000.0 Hz

*For setting Volt Mode → VOLT&RATIO  
with X- or Z-Axis → VOLT selected*

```
VOLTAGE CH1
. Volt Ch2:1 4.0000 :1
. Spacing LIN POINTS
. Start 0.0100 FS
. Stop 0.5000 FS
. Points 30
```

*For setting Volt Mode → VOLT CH1&2  
with X- or Z-Axis → VOLT selected*

```
VOLTAGE CH1
. Spacing LIN POINTS
. Start 0.0100 FS
. Stop 0.5000 FS
. Points 30
. Volt Ch2 0.5000 FS
```

*For setting von SWEEP CTRL → AUTO LIST or MANU LIST the following applies:*

```
. Next Step ANLR SYNC with AUTO LIST only
. X Axis FREQ
. Z Axis OFF
```

*For setting Freq Mode → FREQ&PHASE  
with X- or Z-Axis → FREQ selected*

```
. FREQ FILE R&S_EXAM.SPF
. Phas Ch2:1 0.0000 °
. VOLT CH1 0.5000 FS
. Volt Ch2:1 4.0000 :1
```

*For setting Freq Mode → FREQ CH1&2  
with X- or Z-Axis → FREQ selected*

```
. FREQ FILE R&S_EXAM.SPF
. Freq Ch2 1000.0 Hz
. VOLT CH1 0.5000 FS
. Volt Ch2:1 4.0000 :1
```

*For setting Volt Mode → VOLT&RATIO  
with X- or Z-Axis → VOLT selected*

```
. Freq Ch1 21000 Hz
. Freq Ch2 1000.0 Hz
. Volt Ch2:1 4.0000 :1
. VOLT FILE R&S_EXAM.SPF
```

*For setting Volt Mode → VOLT CH1&2  
with X- or Z-Axis → VOLT selected*

```
. Freq Ch1 21000 Hz
. Freq Ch2 1000.0 Hz
. VOLT FILE R&S_EXAM.SPF
. Volt Ch2 0.5000 FS
```

**FUNCTION MULTISINE**

```
. DC Offset OFF with ON: 0.0000 FS or 0.0000 V
. Spacing USER DEF
. 10.000 Hz
. Mode DEFINE VOLT
. Equalizer OFF
. Crest Fact OPTIMIZED
. Equal.File R&S_EXAM.VEQ with equalizer ON
. No of Sin 2
```

- Multisine CHOICE ...
- TOTAL GAIN 0.0000 dB
- TOTAL PEAK 1.0000 V[FS]
- TOTAL RMS 1.0000 V for INSTRUMENT ANLG only
- Ampl Var OFF

*For setting Ampl Var → SINE*

- Mod Freq 10.000 Hz
- Variation 0.0000 %

*For setting Ampl Var → BURST*

- ON TIME 0.0100 s
- INTERVAL 1.0000 s

*For setting "No of Sin 17" and Crest Fact → OPTIMIZED the following applies:*

Multisine		
	Frequency	Voltage
1	1000.0 Hz	0.5000 V [FS]
2	40.000 Hz	0.5000 V
3	60.000 Hz	0.0000 V
4	120.00 Hz	0.0000 V
5	250.00 Hz	0.0000 V
6	310.00 Hz	0.0000 V
7	500.00 Hz	0.0000 V
8	1000.0 Hz	0.0000 V
9	2000.0 Hz	0.0000 V
10	4000.0 Hz	0.0000 V
11	6290.0 Hz	0.0000 V
12	8000.0 Hz	0.0000 V
13	10000 Hz	0.0000 V
14	12500 Hz	0.0000 V
15	14000 Hz	0.0000 V
16	16000 Hz	0.0000 V
17	18000 Hz	0.0000 V

*For setting "No of Sin 17" and Crest Fact → , OPTIMIZED the following applies::*

Multisine			
	Frequency	Phase	Voltage
1	1000.0 Hz	0.0000 °	0.5000 V [FS]
2	40.000 Hz	0.0000 °	0.5000 V
3	60.000 Hz	0.0000 °	0.0000 V
4	120.00 Hz	0.0000 °	0.0000 V
5	250.00 Hz	0.0000 °	0.0000 V
6	310.00 Hz	0.0000 °	0.0000 V
7	500.00 Hz	0.0000 °	0.0000 V
8	1000.0 Hz	0.0000 °	0.0000 V
9	2000.0 Hz	0.0000 °	0.0000 V
10	4000.0 Hz	0.0000 °	0.0000 V
11	6290.0 Hz	0.0000 °	0.0000 V
12	8000.0 Hz	0.0000 °	0.0000 V
13	10000 Hz	0.0000 °	0.0000 V
14	12500 Hz	0.0000 °	0.0000 V
15	14000 Hz	0.0000 °	0.0000 V
16	16000 Hz	0.0000 °	0.0000 V
17	18000 Hz	0.0000 °	0.0000 V

**FUNCTION SINE BURST | SINE<sup>2</sup> Burst**

- DC Offset OFF with ON: 0.0000 FS or 0.0000 V
- Equalizer OFF
- Equal.File R&S\_EXAM.VEQ with Equalizer ON
- SWEEP CTRL OFF
- FREQUENCY 1000.0 Hz
- VOLTAGE 0.5000 V [FS]

*For setting SWEEP CTRL → AUTO SWEEP or MANU SWEEP the following applies:*

- Next Step ANLR SYNC with AUTO SWEEP only
- X Axis VOLT
- Z Axis OFF

*With X or Z axis → VOLT selected*

```
FREQUENCY    1000.0 Hz
VOLTAGE
· Spacing    LIN POINTS
· Start      0.0100 V[FS]
· Stop       0.5000 V[FS]
· Points     30
· Low Level  0.0000 V [FS]    for SINE BURST only
· ON TIME   0.0100 s
· INTERVAL  1.0000 s
· BurstOnDel 0.0000 s
```

*With X or Z axis → FREQ selected*

```
FREQUENCY
· Spacing    LIN POINT
· Start      20000. Hz
· Stop       20.000 Hz
· Points     30                points 2 for SINE2 burst
· VOLTAGE   0.0100 V [FS]
· Low Level  0.0000 V [FS]    for SINE BURST only
· ON TIME   0.0100 s
· INTERVAL  1.0000 s
· BurstOnDel 0.0000 s
```

*With X or Z axis → ON TIME selected*

```
· FREQUENCY  20000 Hz
· VOLTAGE    0.0100 V [FS]
· Low Level  0.0000V [FS]    for SINE BURST only
ON TIME
· Spacing    LIN POINTS
· Start      0.0010 s
· Stop       0.2000 s
· Points     30
· INTERVAL  1.0000 s
· BurstOnDel 0.0000 s
```

*With X or Z axis → INTERVAL selected*

```
· FREQUENCY  20000 Hz
· VOLTAGE    0.0100 V [FS]
· Low Level  0.0000V [FS]    for SINE BURST only
· ON TIME    0.0010 s
INTERVAL
· Spacing    LIN POINTS
· Start      1.0000 s
· Stop       0.0200 s
· Points     30                points 2 for SINE2 burst
· BurstOnDel 0.0000 s
```

*For setting SWEEP CTRL → AUTO LIST or MANU LIST the following applies:*

```
· Next Step  ANLR SYNC    with AUTO LIST only
· X Axis     FREQ
· Z Axis     OFF
```

*With X or Z axis → VOLT selected*

```
· FREQUENCY  1000.0 Hz
· VOLT FILE  R&S_EXAM.SPV
· Low Level  0.0000 V [FS]    for SINE BURST only
· ON TIME    0.0100 s
· INTERVAL  1.0000 s
```

- BurstOnDel 0.0000 s

*With X or Z axis → FREQ selected*

- FREQ FILE R&S\_EXAM.SPF
- VOLTAGE 0.5000 V
- Low Level 0.0000 V [FS] for SINE BURST only
- ON TIME 0.0100 s
- INTERVAL 1.0000 s
- BurstOnDel 0.0000 s

*With X or Z axis → ON TIME selected*

- FREQUENCY 1000.0 Hz
- VOLTAGE 0.5000 V [FS]
- Low Level 0.0000 V [FS] for SINE BURST only
- ONTIM FILE R&S\_EXAM.SPO
- INTERVAL 1.0000 s
- BurstOnDel 0.0000 s

*With X or Z axis → INTERVAL selected*

- FREQUENCY 1000.0 Hz
- VOLTAGE 0.5000 V [FS]
- Low Level 0.0000 V [FS] for SINE BURST only
- ON TIME 0.0100 s
- INTV FILE R&S\_EXAM.SPI
- BurstOnDel 0.0000 s

**FUNCTION MOD DIST**

- Frq Offset OFF
- DC Offset OFF with ON: 0.0000 FS or 0.0000 V
- SWEEP CTRL OFF
- UPPER FREQ 4000.0 Hz
- LOWER FREQ 40.000 Hz
- Volt LF:UF 4.0000 :1
- TOTAL VOLT 1.0000 V

*For setting SWEEP CTRL → AUTO SWEEP or MANU SWEEP the following applies:*

- Next Step ANLR SYNC with AUTO SWEEP only
- X Axis FREQ
- Z Axis OFF

*With X or Z axis → FREQ selected*

UPPER FREQUENCY

- Spacing LOG POINTS
- Start 20000. Hz
- Stop 4000.0 Hz
- Points 30
- LOWER FREQ 40.000 Hz
- VOLT LF:UF 4.0000 :1
- TOTAL VOLT 1.0000 V [FS]

*With X or Z axis → VOLT selected*

TOTAL VOLTAGE

- UPPER FREQ 20000 Hz
- LOWER FREQ 40.000 Hz
- VOLT LF:UF 4.0000 :1

TOTAL VOLTAGE

- Spacing LIN POINTS
- Start 0.0100 V[FS]
- Stop 0.5000 V[FS]
- Points 30

*For setting SWEEP CTRL → AUTO LIST or MANU LIST the following applies:*

- Next Step ANLR SYNC with AUTO LIST only
- X Axis FREQ
- Z Axis OFF

*With X or Z axis → FREQ selected*

- UPP F.FILE R&S\_EXAM.SPF if X or Z axis → FREQ selected
- LOWER FREQ 40.000 Hz
- VOLT LF:UF 4.0000 :1
- TOTAL VOLT 1.0000 V [FS]

*With X or Z axis → VOLT selected*

- UPPER FREQ 4000.0 Hz
- LOWER FREQ 40.000 Hz
- VOLT LF:UF 4.0000 :1
- TOT V.FILE R&S\_EXAM.SPV

**FUNCTION DFD**

- Frq Offset OFF
- DC Offset OFF with ON: 0.0000 FS or 0.0000 V
- MODE IEC 268

*For setting the IEC 268 mode the following applies:*

- Equalizer OFF
- Equal.File R&S\_EXAM.VEQ with Equalizer ON
- SWEEP CTRL OFF
- MEAN FREQ 12500. Hz
- DIFF FREQ 80.000 Hz
- TOTAL VOLT 1.0000 V

*For setting the IEC 118 mode the following applies:*

- Equalizer OFF
- Equal.File R&S\_EXAM.VEQ with Equalizer ON
- SWEEP CTRL OFF
- UPPER FREQ 12500. Hz
- DIFF FREQ 80.000 Hz
- TOTAL VOLT 1.0000 V

*For setting SWEEP CTRL → AUTO SWEEP or MANU SWEEP the following applies:*

- Next Step ANLR SYNC with AUTO SWEEP only
- X Axis FREQ
- Z Axis OFF

*With X or Z axis → VOLT selected*

- MEAN FREQ 12500 Hz
  - DIFF FREQ 80.000 Hz
- TOTAL VOLTAGE
- Spacing LIN POINTS
  - Start 0.0100 V[FS]
  - Stop 0.5000 V[FS]
  - Points 30

UPPER FREQ with IEC 118 mode selected

*With X or Z axis → FREQ selected*

- MEAN FREQUENCY
- Spacing LIN POINTS
  - Start 20000 Hz
  - Stop 200.0 Hz
  - Points 30
  - DIFF FREQ 80.000 Hz
  - TOTAL VOLT 0.0100 V [FS]

UPPER FREQUENCY with IEC 118 mode selected

*For setting SWEEP CTRL → AUTO LIST or MANU LIST the following applies:*

- Next Step ANLR SYNC
- X Axis FREQ
- Z Axis OFF

with AUTO LIST only

*With X or Z axis → VOLT selected*

- MEAN FREQ 12500 Hz
- DIFF FREQ 80.000 Hz
- TOT V.FILE R&S\_EXAM.SPV

UPPER FREQUENCY with IEC 118 mode selected

*With X or Z axis → FREQ selected*

- MEAN F.FILE R&S\_EXAM.SPF
- DIFF FREQ 80.000 Hz
- TOTAL VOLT 1.0000 V [FS]

UPP F . FILE with IEC 118 mode selected

**FUNCTION      RANDOM**

- DC Offset OFF
- Domain TIME
- PDF GAUSS
- VOLT PEAK 1.0000 V [FS]
- VOLT RMS 0.2550 V

with ON: 0.0000 FS or 0.0000 V

in analog generator only

*For setting Domain FREQ the following applies:*

- Spacing USER DEF
- 10.000 Hz
- Shape WHITE
- Lower Freq 10.000 Hz
- Upper Freq 20000. Hz
- Equalizer OFF
- Equal.File R&S\_EXAM.VEQ
- VOLT PEAK 1.0000 V [FS]
- VOLT RMS 1.0000 V
- Ampl Var OFF

with equalizer ON

in analog generator only

*For setting Ampl Var → SINE*

- Mod Freq 10.000 Hz
- Variation 0.0000 %

*For setting Ampl Var → BURST*

- ON TIME 0.0100 s
- INTERVAL 1.0000 s



<b>FUNCTION</b>	<b>ARBITRARY</b>	
. DC Offset	OFF	with ON: 0.0000 FS or 0.0000 V
. Shape File	R&S_EXAM.TTF	
. VOLT PEAK	1.0000 V [FS]	
. VOLT RMS	1.0000 V	in analog generator only
. Ampl Var	OFF	

*For setting Ampl Var → SINE*

. Mod Freq 10.000 Hz  
. Variation 0.0000 %

*For setting Ampl Var → BURST*

. ON TIME 0.0100 s  
. INTERVAL 1.0000 s

FUNCTION	POLARITY	
. DC Offset	OFF	with ON: 0.0000 FS or 0.0000 V
. VOLTAGE	0.5000 V [FS]	

FUNCTION	FSK	
. DC Offset	OFF	with ON: 0.0000 FS or 0.0000 V
. VOLTAGE	0.5000 V[FS]	

FUNCTION	RANDOM+ANLR	
. DC Offset	OFF	with ON: 0.0000 FS bzw. 0.0000 V
. Spacing	USER DEF 10.000 Hz	
. Lower Freq	350.00 Hz	
. Upper Freq	550.00 Hz	
. Crest Fact	OPTIMIZED	

*For setting Crest Fact → Value:*  
1.0000

. RND PEAK	1.0000 V FS
. RND RMS	0.3869 V FS
. Loop Chan	1
. Loop Gain	0.0000 *

FUNCTION	MODULATION	
. DC Offset	OFF	with ON: 0.0000 V   FS
. Mode	FM	
. Mod Freq	1000.0 Hz	
. Deviation	0.5000 %	
. Carr Freq	40.000 Hz	
. Carr Volt	0.5000 V FS	

*For setting Mode → AM*

. Mod Freq	1000.0 Hz
. Mod Depth	0.5000 %
. Carr Freq	40.000 Hz
. Carr Volt	0.5000 V FS

FUNCTION	DC
. SWEEP CTRL	OFF
. VOLTAGE	1.000 V FS

*For setting von SWEEP CTRL → AUTO SWEEP or MANU SWEEP the following applies:*

. Next Step	ANLR SYNC	
. X Axis	VOLT	only Volt
VOLTAGE		
. Spacing	LIN POINTS	
. Start	0.0100 V FS	
. Stop	0.5000 V FS	
. Points	30	

*For setting von SWEEP CTRL → AUTO LIST or MANU LIST the following applies:*

. Next Step	ANLR SYNC	
. X Axis	VOLT	only Volt
. VOLT FILE	R&S_EXAM.SPF	

**FUNCTION**      **CODED AUDIO**      for INSTRUMENT DIGITAL only

. Format          AC-3  
. Chan Mode      2/0 192kb/s  
. SWEEP CTRL    OFF

*SWEEP Setting like Function SINE*

. Vari Mode      FREQUENCY  
. FREQUENCY    1000.0 Hz  
. TOTAL VOLT    0.1000 FS

## A.2 Default Settings of Analyzer

### INSTRUMENT — ANLG 22kHz

For setting ANALYZER ANLG 22 kHz and ANLG 110 kHz the following applies.

- Min Freq 10 Hz 20 Hz for ANLG 110kHz only
  - Ref Imped 600.00  $\Omega$
  - Channel(s) 1
  - Ch1 Coupl AC
  - Ch1 Input BAL
  - Ch1 Imped 600  $\Omega$
  - Ch1 Common FLOAT
  - Ch1 Range AUTO
- } The same settings apply with channel 2 selected

For setting ANALYZER DIGITAL the following applies:

- Meas Mode AUDIO DATA
- Min Freq 10 Hz for Meas Mode AUDIO DATA only
- Channel(s) 1 for Meas Mode AUDIO DATA only
- Input BAL (XLR)
- Sync To AUDIO IN for Meas Mode AUDIO DATA only
- Sample Frq 48 kHz for Meas Mode AUDIO DATA only
- Audio Bits 20 for Meas Mode AUDIO DATA only
- Jitter Ref VARI (PLL) for Meas Mode JITTER/PHAS only

### START COND — AUTO

- Delay 0.0000 s

For setting START COND TIME TICK the following applies:

- Time 1.0000 s
- Points 30

For setting START COND FREQ CH1 | FREQ CH2 the following applies:

- Delay 0.0000 s
- Min Volt 0.0100 V [FS]
- Start 1000.0 Hz
- Stop 10000. Hz
- Variation 10.000 %
- Settling OFF

For setting START COND VOLT CH1 | VOLT CH2 the following applies:

- Delay 0.0000 s
- Start 0.0100 V [FS]
- Stop 1.0000 V [FS]
- Variation 10.000 %
- Settling OFF

For setting START COND LEV TRG CH1 | LEV TRG CH2 the following applies:

- Delay 0.0000 s
- Start 0.0100 V [FS]
- Stop 1.0000 V [FS]
- Variation 10.000 %
- Settling OFF

For setting START COND TIME CHART the following applies:

- Time 1.000 s
- Points 30

*For setting START COND FRQ FST CH1 | FRQ FST CH2 the following applies:*

- Delay 0.0000 s
- Min Volt 0.0100 V [FS]
- Start 1000.0 Hz
- Stop 10000 Hz
- Variation 10.000 %
- Settling OFF

*For setting START COND FREQ CH1|2 | FRQ FST CH1|2 and Settling EXPONENTIAL ½ FLAT the following applies:*

- Samples 3
- Tolerance 1.0000 %
- Resolution 0.0010 Hz

*For setting START COND VOLT CH1|2 | LEV TRG CH1|2 and Settling EXPONENTIAL ½ FLAT the following applies:*

- Samples 3
- Tolerance 1.0000 %
- Resolution 0.0010 V [FS]

**Functions common to all analyzers**

*Input measurement for analog analyzers*

**INPUT DISP PEAK | RMS**

- Unit Ch1 V
- Unit Ch2 V with two-channel measurement
- Reference VALUE:  
1.0000 V [FS]

*Input measurement for digital analyzer in Meas Mode AUDIO DATA*

**INPUT DISP PEAK | RMS**

- Unit Ch1 dBFS FS for RMS
- Unit Ch2 dBFS FS for RMS, with two-channel measurement
- Reference VALUE:  
1.0000 FS

*Input measurement for digital analyzer in Meas Mode COMMON/INP*

**INPUT DISP PEAK | DIG INP AMP**

- Unit Ch1 V
- Reference VALUE:  
1.0000 V[FS]

*Input measurement for digital analyzer in Meas Mode JITTER/PHAS*

**INPUT/PHAS PEAK**

- Unit Ch1 UI %FRM for PHAS TO REF
- Reference VALUE:  
1.0000 UI for PEAK only  
for PEAK only

**INPUT/PHAS PHAS TO REF**

- Unit %FRM



*For setting Freq Sett1 AVERAGE the following applies:*

- Samples 3

*For setting Phas Sett1 EXPONENTIAL / FLAT the following applies:*

- Samples 3
- Resolution 0.1000 °
- Timeout 5.0000 s

*For setting Phas Sett1 AVERAGE the following applies:*

- Samples 3

**Functions of all analyzers:**

- | <b>FUNCTION</b> | <b>RMS &amp; S/N</b>    |                              |
|-----------------|-------------------------|------------------------------|
| • DC Suppres    | ON                      | for digital- analysator only |
| • S/N Sequ      | OFF                     | for analogen analyzers only  |
| • Meas Time     | AUTO FAST               |                              |
| • Unit Ch1      | V [FS]                  |                              |
| • Unit Ch2      | V [FS]                  | (with channel 2 activated)   |
| • Reference     | VALUE:<br>1.0000 V [FS] |                              |
| • Notch (Gain)  | OFF                     | for analogen analyzers only  |
| • Filter        | OFF                     |                              |
| • Filter        | OFF                     |                              |
| • Filter        | OFF                     |                              |
| • Fnct Sett1    | OFF                     |                              |
| • POST FFT      | OFF                     |                              |
| • SPEAKER       | OFF                     |                              |

*For setting POST FFT = ON the following applies:*

- FFT Size 4096
- Window RIFE VINC 2

- | <b>FUNCTION</b> | <b>RMS SELECT</b>       |  |
|-----------------|-------------------------|--|
| • DC Suppres    | ON                      | for digital- analysator only               |
| • Meas Time     | AUTO                    |  |
| • Unit Ch1      | V [FS]                  |  |
| • Unit Ch2      | V [FS]                  | if channel 2 is on                         |
| • Reference     | VALUE:<br>1.0000 V [FS] |  |
| • Sweep Mode    | NORMAL                  |  |
| • Bandwidth     | BP 1%                   | with bandwidth BP FIX or BS FIX: 100.00 Hz |
| • SWEEP CTRL    | OFF                     |  |
| • FREQ MODE     | GEN TRACK               |  |
| • Factor        | 1.0000 *                | with FREQ MODE GEN TRACK only              |

*For setting SWEEP CTRL AUTO SWEEP, MANU SWEEP the following applies:*

- Spacing LOG POINTS
- Start 100.00 Hz
- Stop 20000. Hz
- Points 30

For setting SWEEP CTRL AUTO LIST, MANU LIST the following applies:

- Filename R&S\_EXAM.SPF

For setting SWEEP CTRL GEN MLTSINE the following applies:

There are no further parameters

- Notch(Gain) OFF for analogen analyzers only
- Fiter OFF for analogen analyzers only
- Fnct Sett1 OFF
- SPEAKER OFF

**FUNCTION PEAK & S/N** for analyzers ANLG 22kHz and DIGITAL only

- S/N Sequ OFF
- Meas Mode PK+
- Intv Time FIX 200ms
- Unit Ch1 V [FS]
- Unit Ch2 V [FS] (if channel 2 is on)
- Reference VALUE:  
1.0000 V [FS]
- Filter OFF
- Filter OFF
- Filter OFF
- Fnct Sett1 OFF
- SPEAKER OFF

**FUNCTION QPK & S/N** for analyzers ANLG 22 kHz and DIGITAL

- S/N Sequ OFF
- Intv Time FIX 3
- Unit Ch1 V [FS]
- Unit Ch2 V [FS] with channel 2 activated
- Reference VALUE:  
1.0000 V [FS]
- Notch (Gain) OFF for analog analyzers only
- Filter OFF
- Filter OFF
- Filter OFF
- Fnct Sett1 OFF
- SPEAKER OFF

**FUNCTION DC**

- Meas Time FIX 200ms
- Unit Ch1 V [FS]
- Unit Ch2 V [FS] if channel 2 is on
- Reference VALUE:  
1.0000 V|FS
- Fnct Sett1 OFF
- SPEAKER OFF

**FUNCTION THD**

- Meas Mode All di
- Dyn Mode PRECISION for analogen analyzers only
- Unit dB
- Fundament1 AUTO
- Fnct Sett1 OFF
- SPEAKER OFF



<b>FUNCTION</b>	<b>THD+N/SINAD</b>	
· Meas Mode	THD+N	
· Dyn Mode	PRECISION	for analog analyzers only
· Meas Time	SLOW	
· Rejektion	NARROW	for digital analyzer only
· Unit	dB	
· Fundamentl	AUTO	
· FILTER	OFF	
· FrqLim Low	100.00 Hz	128 Hz for ANLG 110kHz
· FrqLim Upp	20000. Hz	
· Fnct Sett1	OFF	
· POST FFT	OFF	
· Equalizer	OFF	
· Equal.File	R&S_EXAM.VEQ	with Equalizer ON
· SPEAKER	OFF	

*For setting POST FFT ON the following applies:*

- FFT Size 8192
- Window RIFE VINC 3

<b>FUNCTION</b>	<b>MOD DIST</b>	
· Dyn Mode	PRECISION	for analog analyzers only
· Unit	dB	
· Fnct Sett1	OFF	
· SPEAKER -	OFF	

<b>FUNCTION</b>	<b>DFD</b>	
· Meas Mode	d2 (IEC 268)	
· Dyn Mode	PRECISION	for analogen analyzers only
· Unit	dB	
· Fnct Sett1	OFF	
· SPEAKER -	OFF	

<b>FUNCTION</b>	<b>WOW &amp; FL</b>	
· Standard	DIN/IEC	in analyzers ANLG 22 kHz and DIGITAL
· Weighting	ON	
· Unit	%	
· Fnct Sett1	OFF	
· POSTFFT	OFF	
· SPEAKER -	OFF	

*For setting POST FFT the following applies:*

- FFT Size 8192
- Window RIFE VINC 1

**FUNCTION POLARITY**

There are no further parameters

<b>FUNCTION</b>	<b>FFT</b>	
· DC Suppres	ON	with digital analysator only
· Unit Ch1	dBV [dbFS]	
· Reference	VALUE: 1.0000 V [FS]	
· Notch (Gain)	OFF	for analogen analyzers only
· FFT Size	4096	
· Filter	OFF	
· Filter	OFF	
· Filter	OFF	
· Window	RIFE VINC 2	RIFE VINC 3 for digital analyzers
· Avg Mode	EXPONENTIAL	
· Avg Count	1	
· Zooming	OFF	
· Equalizer	OFF	
· Equal.File	R&S_EXAM.VEQ	with Equalizer ON
· SPEAKER -	OFF	

For setting ZOOMING ON the following applies:

- Zooming ON (2 to 128)      Zooming ON (2 to 8) for ANLG 110 kHz
- Center 10000 Hz
- Span 21.94 kHz      SPAN 140.40 for ANLG 110 kHz  
In the digital analyzer, the value depends on the selected sample rate
- Zoom Fact 2

#### FUNCTION      FILTER SIM.

- Unit %
- Filter OFF
- Filter OFF
- Filter OFF
- SPEAKER – OFF

#### FUNCTION      WAVEFORM

- DC Suppres ON      with digital analysator only
- Meas Mode STANDARD
- Unit V [FS]
- REF VOLT 1.0000 V
- Filter OFF
- Trig Level 0.0000 V
- Trig Slope RISING
- Interpol 1
- Trace Len 0.0100 s
- Trig Src CHAN 1      for analog analyzer ANLG 22kHz only
- SPEAKER – OFF

#### FUNCTION      PROTOCOL

there are no further parameters

for digital analyzer only

#### FUNCTION      COHERENCE

- Unit %
- Chan Delay 0.0000 s      for analyzers ANLG 22kHz and DIGITAL only with two channels
- FFT Size 4096
- Window RIFE VINC 2
- Avg Count 2
- Start 0.0000 Hz
- Stop 21938 Hz
- Resolution 11.719 Hz

#### FUNCTION      RUB & BUZZ

- Meas Time GEN TRACK      with analog analyzer only
- Unit Ch1 V
- Reference VALUE:
- 1.0000 V
- FREQ MODE GEN TRACK
- Factor 2.0000 \*
- Sweep Mode NORMAL
- Filter OFF
- FrqLim Low 100.0 Hz
- FrqLim Upp 21938 Hz      120 kHz with analyzer ANLG 110 kHz only

**FUNCTION      3rd OCTAVE**                      for analyzers ANLG 22kHz and DIGITAL

- . Line Count 30
- . Meas Time VALUE
- .                      0.5013 s
- . Max Hold OFF
- . Unit Ch1 V [FS]
- . Unit Ch2 V [FS]
- . Reference VALUE:
- .                      1.0000 V [FS]
- . Filter OFF
- . FrqLim Low 100.00 Hz
- . FrqLim Upp 21938 Hz

**FUNCTION      12th OCTAVE** for analyzers ANLG 22kHz and DIGITAL

- . Meas Time VALUE
- .                      1.3925 s
- . Max Hold OFF
- . Unit Ch1 V [FS]
- . Unit Ch2 V [FS]
- . Reference VALUE:
- .                      1.0000 V [FS]
- . Filter OFF
- . FrqLim Low 100.00 Hz
- . FrqLim Upp 20586 Hz

**Common to all measurement functions:**

*For setting SPEAKER unequal to OFF the following applies:*

- . Pre Gain 0.0000 dB                      with SPEAKER FUNCT CH1|2|1&2 only
- . Spk Volume 30.000 %
- . Phone Out = SPEAKER

*For setting Fnc Sett EXPONENTIAL / FLAT the following applies:*

- . Samples 3
- . Tolerance 0.1000 %
- . Resolution 0.0010 V
- . Timeout 5.0000 s

*For setting Fnc Sett AVERAGE the following applies:*

- . Samples 3

## A.3 Default Settings of Filter Panel

### Basic parameters of filters:

#### Lowpass filter:

- Order 8
- Passband 20000. Hz
- Attenuat. 60.000 dB
- Short Name 1:LP20.0kHz

#### Highpass filter:

- Order 8
- Passband 400.00 Hz
- Attenuat. 60.000 dB
- Short Name 2:HP400.0Hz

#### Bandpass filter:

- Passb Low 900.00 Hz
- Passb Upp 1100.0 Hz
- Attenuat. 60.000 dB
- Short Name 3:BP900.0Hz

#### Bandstop filter:

- Passb Low 900.00 Hz
- Passb Upp 1100.0 Hz
- Attenuat. 60.000 dB
- Short Name 4:BS900.0Hz

#### Notch filter:

- Center Frq 16000. Hz
- Width 500.00 Hz
- Attenuat. 60.000 dB
- Short Name 5:NO16.0kHz

#### Octave filter (1/3 OCT FLT):

- Center Frq 12500. Hz
- Attenuat. 60.000 dB
- Short Name 7:TO12.5kHz

#### Oktave filter (OCTAVE FLT):

- Center Frq 12500. Hz
- Attenuat. 60.000 dB
- Short Name 8:OC12.5kHz

#### File-defined filter (FILE DEF):

- Filename R&S\_EXAM.COE
- Delay 0.1000 s
- Short Name 9:R&S\_EXAM

### Standard filter types:

```
FILTER 01 LOW PASS
FILTER 02 HIGH PASS
FILTER 03 BAND PASS
FILTER 04 BAND STOP
FILTER 05 NOTCH FLT
FILTER 06 1/3 OCT FLT
FILTER 07 OCTAVE FLT
FILTER 08 FILE DEF.
FILTER 09 FILE DEF.
```

## A.4 Default Settings of Display Panel

### OPERATION BARGRAPH

- Scans COUNT 1
- User Label OFF

### BARGRAPH A FUNC CH1

- Unit V [FS, Hz, dB, %] Basic unit of selected analyzer or bargraph function (see section 2.4 Units)
- Limit Ref VALUE:  
1.0000 V [FS, Hz, dB, %] Basic unit of selected analyzer or bargraph function (see section 2.4 Units)
- Scale AUTO ONCE
- Spacing LIN

### BARGRAPH B OFF

*If the same function was selected for BARGRAPH B and BARGRAPH A:*

- Scale B NOT EQUAL A

*With Scale B → NOT EQUAL A selected :*

- Unit V [FS, Hz, dB, %] Basic unit of selected analyzer or bargraph function (see section 2.4 Units)
- Limit Ref VALUE:  
1.0000 V [FS, Hz, dB, %] Basic unit of selected analyzer or bargraph function (see section 2.4 Units)
- Scale AUTO ONCE
- Spacing LIN

### BARGRAPH X VOLT

- Unit V [FS]
  - Reference 10000 V [FS]
  - Scale AUTO
  - Spacing LIN
- VOLT, FREQ, ON TIME and INTERVAL are displayed depending on the setting under X axis in the case of a generator sweep. For a sweep of the center frequency of the rms selective bandpass filter in the analyzer with measurement function RMS SELECT, FREQ is displayed.

### BARGRAPH X FREQ

- Unit Hz
- Reference 1000.0 Hz
- Scale AUTO
- Spacing LIN

### BARGRAPH X ON TIME | INTERVAL

- Unit S
- Scale AUTO
- Spacing LIN

### LIMIT CHECK

- Mode OFF

*For setting "Mode LIM LOWER, LIM UPPER, LIM LOW&UP" the following applies:*

- Check TRACE A
- Lim Upper VALUE: 0.5000 V not with LIM LOWER
- Lim Upper VALUE: 0.0500 V not with LIM UPPER

## A.5 Default Settings of Options Panel

- Remote via IEC BUS with remote control option (UPL-B4) installed
- UPL IECadr 20 not with remote control via COM2
- Beeper ON
- PARAM.LINK \_\_\_\_\_
- Param Link CHOICE... Function tracking Gen → Anl selected
- DIGITAL AUDIO I/O \_\_\_\_\_
- Sampl Mode BASE RATE The HIGH RATE-Mode (96 kHz-Instrument) has also the default setting described here
- SCREEN HARD COPY \_\_\_\_\_

For setting **Destin** → **PRINTR/SPC** the following applies:

- Destin PRINTR/SPC
- Printname Default-Printer Default Printer stands for the printer selected last by the user. If printer 0 is selected in the setup, loading the default setup does not overwrite the printer type selected by the user.
- Frame Col FILE DEF
- Comment ON
- Left Mrgn 10 Chars
- Prn Resol HIGH
- X Scaling 1.5000
- Y Scaling 1.5000
- Orientatn PORTRAIT

For setting **Destin** → **PLOTTR/HPGL | PRINTR/HPGL** the following applies:

- Destin PLOTTR/HPGL | PRINTR/HPGL
- Color OFF
- Copy SCREEN
- Plot on COM2
- IEC Adr 4 with Plot on = IEC BUS

For setting **Destin** → **FILE/PCX** the following applies:

- Destin FILE/PCX
- Color OFF
- Frame Col FILE DEF
- Plot on COM2

For setting **Destin** → **FILE/HPGL** the following applies:

- Destin FILE/HPGL
- Color OFF
- Copy SCREEN
- Filename SCREEN

For setting **Destin** → **PRINTR/PS | FILE/PS | FILE EPS** the following applies:

- Destin PRINTR/PS | FILE/PS | FILE EPS
- Color OFF
- Comment ON
- Paper Size A4
- Orientatn LANDSCAPE
- Plot on COM2
- Plots/Page 1

- PRINT \_\_\_\_\_
- Type OFF

- COM2 PARAMETER \_\_\_\_\_
- Baud Rate 9600
  - Parity EVEN
  - Data Bits 7
  - Stop Bits 1
  - Handshake RTS/CTS

This standard setting is only set when the BACKSPACE key is pressed during UPL switch-on, UPL-d is entered or after a (new) installation of an UPL software.  
COM2 parameters remain unchanged when a default setup is loaded. This prevents interface parameters, which have to correspond to those of the connected device, being overwritten by mistake.

PANEL KEYS \_\_\_\_\_  
· Reptn Rate 10.000 Hz  
· Rep Delay 0.5000 s

DISPLAY \_\_\_\_\_  
· Extrn Disp BOTH AUTO  
· Meas Disp ON  
· Read Rate 6/s  
· Read Resol CHOICE ... Automatic for all 6 displays

TRACES COLOR/LINE \_\_\_\_\_  
· Scan Conf MANUAL  
· Scannr. (A) 0  
· Color (A) GREEN  
· Line (A) \_\_\_\_\_  
· Scannr. (B) 0  
· Color (B) GREEN  
· Line (B) \_\_\_\_\_

HELP LANGUAGE \_\_\_\_\_  
· Language GERMAN

CALIBRATION ANL \_\_\_\_\_  
· Zero Auto ON

CALIBRATION GEN \_\_\_\_\_  
· PhaseToRef OFF  
· DIAGNOSTIC password ?  
· Device INSTALL KEY  
· Option No. 0  
· InstallKey 0

## A.6 Default Settings of File Panel

### LOAD INSTRUMENT STATE ——

- Applicat USER DEF
- Mode ACTUAL
- Info Displ ON
- Filename LASTSAVE

### STORE INSTRUMENT STATE ——

- Mode ACTUAL
- Attrib READ/WRITE
- Info Text no infotext
- Filename LASTSAVE

### STORE TRACE/LIST —————

- Store OFF

### UTILS —————

- Delete TO\_DELETE
- Work Dir C:\UPL\USER
- COPY SOURCE
- To DEST





## A

- A weighting..... 2.208
- A WITH \* ..... 2.343
- A WITH o..... 2.343
- Abort..... 2.364
- Abort event..... 2.358, 2.363
- AC coupling..... 2.147
- AC coupling input unit..... 2.151
- AC supply network..... 1.1
- AC supply voltages..... 1.1
- AC-3..... 2.135
- AC-3 format..... 2.135
- Activating
  - STATUS panel..... 2.293
- Activation panels..... 2.31
- ACTUAL..... 2.298, 2.299
- Actual instrument setup..... 2.298, 2.299
- Actual setup..... 2.298, 2.299
- Actual setup and data..... 2.299
- ACTUAL+DATA..... 2.299
- Address
  - IEC/IEEE bus..... 3.4
- Addressed commands..... 3.295
- AES Ch1..... 2.262
- AES Ch1&2..... 2.262
- AES Ch2..... 2.262
- AES/EBU protocol definition..... 2.78
- AES/EBU receivers
  - reset..... 2.365
- ALL..... 2.348
- All di..... 2.200
- All even di..... 2.200
- All odd di..... 2.200
- ALL ONE..... 2.74
- ALL ZERO..... 2.74
- AM..... 2.132
- Ampl Var..... 2.89, 2.105, 2.122, 2.126
- Amplitude
  - distribution..... 2.86
  - ratio (MOD DIST)
    - generator..... 2.111
- Amplitude accuracy..... 2.226
- Amplitude entry
  - FM..... 2.132
- Amplitude list (list sweep)..... 2.141
- Amplitude modulation..... 2.132
- Amplitude ratio (MOD DIST)
  - analyzer..... 2.212
- Amplitude Variation..... 2.89
- Analog
  - analyzer..... 2.146
- Analog Ampl..... 2.139
- Analog Freq..... 2.139
- Analog generator..... 2.66
- Analog interfaces
  - Input connectors..... 2.9
- Analog notch filter..... 2.201, 2.205, 2.213
- ANALOG OUT..... 2.138
- Analyzer
  - availability of functions..... 2.144
  - configuration..... 2.146
  - Filters..... 2.278
  - input peak measurement..... 2.144
  - input peak measurements..... 2.235
  - instruments..... 2.142
  - measurement functions..... 2.165
  - measurement range limits..... 2.143
  - reference value..... 2.169, 2.172
  - Settings..... 2.16
  - synchronization..... 2.94
  - ways of starting..... 2.159
- ANALYZER panel..... 2.142
- Analyzers
  - reference values..... 2.172
- ANLG - ANLG..... 2.297
- ANLG - DIGI..... 2.297
- ANLG 25 kHz..... 2.65
- ANLR key..... 2.3, 2.278
- ANLR SYNC..... 2.94
- ANLR TRACK..... 2.101
- ANLR-TRACK..... 2.118
- Application..... 2.297
- application setups..... 2.297
- ARBITRARY..... 2.85
- ARBITRARY signals
  - measuring on..... 2.181
- Arbitrary waveform..... 2.85
- Arith. symm. bandwidth RMS sel..... 2.186
- Arithmetic averaging, settling..... 2.42, 2.175
- ASCII..... 2.305, 2.354
- ASCII format..... 2.305
- Asterisk..... 3.15
- Asymmetrical sine burst..... 2.85
- AT o DOWN..... 2.340
- AT o UP..... 2.340
- Atten..... 2.285
- Attenuation..... 2.284
- Attrib..... 2.300
- Attribute..... 2.300
- AUD IN RCLK..... 2.74
- Audio Bits..... 2.75, 2.157
- AUDIO DATA..... 2.71, 2.153
- AUDIO IN..... 2.71, 2.72, 2.74, 2.156
- AUDIO OUT..... 2.71, 2.74
- AUTO..2.157, 2.159, 2.174, 2.179, 2.185, 2.202, 2.207, 2.248
- AUTO COLOR..... 2.397
- AUTO FAST..... 2.179, 2.185, 2.248
- AUTO LINE..... 2.397
- AUTO LIST
  - Generator-Sweep..... 2.93
- AUTO ONCE..... 2.335, 2.348
- AUTO Range
  - Analyzer..... 2.149
  - generator..... 2.67
- AUTO SCALE..... 2.335, 2.338, 2.348
- AUTO SCALE..... 2.335
- AUTO SWEEP
  - analyzer..... 2.187
  - Generator..... 2.93
- Automatic
  - sweep..... 2.187
  - sweep..... 2.93
- Automatic control, size of data memory..... 3.356
- Automatic range selection..... 2.149
- AUX GEN..... 2.138
- Availability
  - phase measurement..... 2.240
  - sweep parameters..... 2.91
- AVERAGE..... 2.175
- AVERAGE, settling..... 2.42
- Averaging
  - FFT..... 2.223
  - measurement results..... 2.42
- Averaging method in the FFT..... 2.223
- Avg Count..... 2.223, 2.245
- Avg Mode..... 2.223

## B

B WITH \* ..... 2.343  
 B WITH o ..... 2.343  
 BACK softkey ..... 2.337  
 BACKSP ..... 2.5  
 BAL  
   Generator ..... 2.139  
 BAL XLR  
   analyzer ..... 2.148, 2.154  
   Generator ..... 2.66, 2.139  
 Balanced Output ..... 2.69  
 Band limit  
   THD+N / SINAD ..... 2.208  
 Band limits  
   analyzer instruments ..... 2.143  
 BAND PASS ..... 2.287  
 BAND STOP ..... 2.287  
 Bandpass ..... 2.184  
   center frequency ..... 2.194  
   RMS sel ..... 2.184  
 Bandpass ..... 2.287  
 Bandstop ..... 2.287  
 bandwidth  
   third octave ..... 2.252  
   twelfth octave ..... 2.256  
 Bandwidth  
   analyzer ..... 2.186  
   RMS Select ..... 2.186  
 Bandwidth bandpass RMS sel ..... 2.186  
 BAR 1 ..... 2.348  
 BAR 2 ..... 2.348  
 BAR 3 ..... 2.348  
 Bar chart  
   MOD DIST ..... 2.213  
 BARGRAPH ..... 2.327  
 BARGRAPH display ..... 2.347, 2.349  
 BARGRAPH display parameters ..... 2.347  
 BARGRAPH X ..... 2.347  
 BARGRAPH1 ..... 2.347  
 BARGRAPH2 ..... 2.347  
 BASIC-Macro ..... 3.329  
 Battery replacement ..... 4.8  
 baud ..... 2.409  
 Baud Rate ..... 2.391  
 Beats  
   DC measurement ..... 2.198  
   RMS measurement ..... 2.181  
 Beeper ..... 2.393  
 Beeper On/Off ..... 2.393  
 BIN ENTRY ..... 2.79, 2.81  
 BINARY ..... 2.354  
 Binary block data ..... 3.364  
 Binary data blocks ..... 3.12  
 Binary form ..... 2.305  
 BIOS-SETUP ..... 4.2  
 BIPHASE CLK ..... 2.74  
 Biquads ..... 2.229  
 BLACKMAN-HARRIS ..... 2.222, 2.245  
 BLOCK ..... 2.182, 2.193, 2.250  
 Boards replacement ..... 4.7  
 Boolean parameter (command) ..... 3.13  
 BOTH ..... 2.153  
 BOTH AUTO ..... 2.394  
 BOTH BW ..... 2.394  
 BOTH COLOR ..... 2.394  
 Bottom ..... 2.335  
 Bounding Box ..... 2.378  
 BP 1% ..... 2.186  
 BP 1/12 OCT ..... 2.186  
 BP 1/3 OCT ..... 2.186  
 BP 3% ..... 2.186

BP FAST ..... 2.186  
 BP FIX: ..... 2.186  
 Broadband noise ..... 2.199  
 BS 1% ..... 2.186  
 BS 1/12 OCT ..... 2.186  
 BS 1/3 OCT ..... 2.186  
 BS 3% ..... 2.186  
 BS FAST ..... 2.186  
 BS FIX: ..... 2.186  
 BURST ..... 2.89, 2.105, 2.122, 2.126  
   burst duration ..... 2.90, 2.105, 2.123, 2.126  
   Burst duration SINE BURST ..... 2.108  
   Burst on Del ..... 2.108, 2.110  
   Burst signal SINE ..... 2.106

## C

C 448 kb/s ..... 2.135  
 C MESSAGE ..... 2.208  
 Cable Sim ..... 2.72  
 Cable Simulation ..... 2.72  
 Calculation of filters ..... 2.285, 2.291  
 Calibration ..... 2.399  
   DIG ..... 2.399  
 Calibration ANL ..... 2.399  
 Calibration GEN ..... 2.399  
 Calibration of low-distortion generator ..... 2.399  
 CANCEL ..... 2.5, 2.13, 2.34, 2.35  
 CANCEL .....  
 Carr Freq ..... 2.132  
 Carr Volt ..... 2.132  
 Carrier frequency  
   FM ..... 2.132  
 CCIR 409-J standard W&F ..... 2.217  
 CCIR unwt'd ..... 2.208  
 CCIR wtd ..... 2.208  
 CCIT ARM ..... 2.208  
 CCITT 0.41 ..... 2.208  
 CEN TO o ..... 2.340  
 Center ..... 2.224  
 Center Freq ..... 2.289, 2.290  
 Center frequency  
   bandpass RMS sel ..... 2.194  
   DFD ..... 2.115  
   notch filter ..... 2.174  
 Center frequency ..... 2.290  
 Centronics ..... 2.411  
 Ch Stat. L ..... 2.79  
 Ch. Stat. R ..... 2.81  
 Chan delay ..... 2.220, 2.245  
 Chan Mode ..... 2.135  
 CHAN STAT L ..... 2.353  
 CHAN STAT R ..... 2.353  
 CHAN STATUS ..... 2.157  
 Changing  
   an instrument ..... 2.33  
   functions ..... 2.34  
   the panels ..... 2.29, 2.30, 2.31  
 Changing a function  
   parameter link ..... 2.34  
 Changing an instrument  
   parameter link ..... 2.33  
 Changing between the instruments ..... 2.34  
 Changing the unit at a later date ..... 2.35

- Channel
  - sequence..... 2.352
- Channel delay..... 2.220
- Channel Mode..... 2.135
- Channel status..... 2.84
- Channel status data, user data, validity, parity..... 2.78
- Channel(s)
  - analyzer..... 2.146, 2.153
  - generator..... 2.66
  - Generator..... 2.139
- Character
  - data (command)..... 3.13
  - string (command)..... 3.14
- Characteristic notch..... 2.174
- Check..... 2.350
- CHECKSUM ERROR..... 4.5
- CHOICE..... 2.403
- Clock rate generator..... 2.73
- Clock rate error..... 2.352
- CMOS CHECKSUM ERROR..... 4.5
- Coded Audio..... 2.134
- CODED AUDIO..... 2.85
- Coded Audio Signal Generation..... 2.134
- COHERENCE..... 2.165
- Coherence Measurement..... 2.244
- Colon..... 3.15
- Color..... 2.27, 2.398
- Color palette information..... 2.294
- Colour..... 2.377
- Colour display..... 2.394
- Colour display PROTOCOL analysis..... 2.352
- Colour monitor..... 2.394
- Colour monitor..... 2.394
- COM2..... 2.379, 2.390
- COM2 interface..... 2.390
- COM2 PARAMETER..... 2.390
- Comma..... 3.15
- Command
  - addressed..... 3.295
  - Common..... 3.295
  - common commands..... 3.39
  - header..... 3.7
  - hierarchy..... 3.7
  - keyword..... 3.7
  - line
    - delimiter..... 3.9
    - structure..... 3.9
    - numeric suffix..... 3.8
    - parameters..... 3.13
    - permissibility..... 3.19
    - processing..... 3.18
    - structure..... 3.7
    - synchronization..... 3.21
    - syntax elements..... 3.15
- command line option
  - tappl..... 2.296
- command line parameter
  - tthdnwin..... 2.210
- COMMENT..... 2.336
- Comments for hardcopy..... 2.299
- Comments on hardcopy..... 2.298
- Common
  - analyzer..... 2.148
- Common Ampl..... 2.140
- Common commands..... 3.39, 3.295
- form..... 3.7
- Common Freq..... 2.140
- COMMON MODE..... 2.138
- COMMON ONLY..... 2.71
- Common parameters
  - all analyzer functions..... 2.166
  - all filters..... 2.285
  - all generator functions..... 2.87
  - generator signals..... 2.86
  - SINE, DFD, MOD DIST signals..... 2.86
- COMMON/INP..... 2.153
- Comp..... 2.231
- COMPLETE..... 2.298, 2.299
- Complete setup..... 2.298, 2.299
- COMPRESS..... 2.135
- COMPRESSED..... 2.231
- Computer operation of UPL..... 2.412
- CONDition register..... 3.25
- Conditional tracing of measured values..... 2.159
- Configuration
  - analog analyzer..... 2.146
  - analog generator..... 2.66, 2.139, 2.140, 2.141
  - digital analyzers..... 2.153
  - digital generator..... 2.71
- Configuration File PS.CFG..... 2.385
- Connecting
  - external devices..... 2.408
  - external VGA monitor..... 2.11
- CONT..... 2.358
- CONT key..... 2.161
- Continuous measurement..... 2.360
- Continuous measurement without trigger condition..... 2.159
- Contrast..... 1.3
- Control file..... 2.321
- Control panel
  - CONTROL..... 2.5, 2.7
  - CURSOR / VARIATION..... 2.7
  - EDIT..... 2.5
  - Front-panel..... 2.3
- conversion factor..... 2.170
- Conversion factor..... 2.269
- Conversion formula of units..... 2.57
- Copy..... 2.373
- COPY..... 2.27
- coupling
  - AC..... 2.178
  - DC..... 2.178
- Coupling
  - analyzer inputs..... 2.147
- Crest Fact..... 2.102, 2.120
- Crosstalk..... 2.266
- CRT monitor..... 2.411
- Ctrl D..... 2.394
- Cursor
  - graphics..... 2.337, 2.343
  - panel..... 2.31
- Cursor IMAX A..... 2.343
- Cursor IMAX B..... 2.343
- CURVE..... 2.338, 2.373
- Curve plot
  - cursor..... 2.337
  - overrange..... 2.337
  - underrange..... 2.337
- CURVE PLOT..... 2.327
- CURVE/GRID..... 2.373

## D

d2 (IEC 118) ..... 2.215  
d2 (IEC 268) ..... 2.215  
d3 (IEC 118) ..... 2.215  
d3 (IEC 268) ..... 2.215  
Dangerous contact voltages ..... 2.1  
data ..... 2.409  
Data Bits ..... 2.391  
Data entry ..... 2.34  
Data input or output during measurements ..... 2.39  
Data strings (command) ..... 3.14  
DC ..... 2.85, 2.165  
    component ..... 2.87  
    coupling ..... 2.143  
    measurement ..... 2.165, 2.198  
    noise HP ..... 2.208  
    offset ..... 2.87  
    offset calibration ..... 2.399  
    voltage ..... 2.198  
DC coupling ..... 2.147  
DC coupling input unit ..... 2.151  
DC Offset ..... 2.99, 2.101, 2.106, 2.109, 2.111  
    2.114, 2.117, 2.125, 2.127, 2.128  
DC Suppres ..... 2.166, 2.178, 2.184, 2.220  
Decimal point ..... 3.15  
DEEM 50/15 ..... 2.208  
Deemph 50 ..... 2.208  
Deemph 75 ..... 2.208  
Deemph J.17 ..... 2.208  
DEFAULT ..... 2.298, 2.397  
Default setup ..... 2.298  
DEFAULT.SET ..... 2.296  
DEFINE PHASE ..... 2.102  
DEFINE VOLT ..... 2.102  
DEL BEF WR ..... 2.328, 2.330  
Delay  
    filter ..... 2.285  
    restart of measurement ..... 2.162  
Delay value with external sweep ..... 2.50  
Delete ..... 2.321  
DELeTe BEFore WRite ..... 2.330  
Delimiter  
    command line ..... 3.9  
    response to query ..... 3.11  
Destin ..... 2.371, 2.372  
Deviation ..... 2.132  
    FM ..... 2.132  
Deviation settling ..... 2.176  
DFD  
    analyzer ..... 2.165  
    Generator ..... 2.85  
Dialog window  
    multisine ..... 2.103  
DIFF FREQ ..... 2.115  
Difference frequency distortion ..... 2.114, 2.214  
    measurement ..... 2.165, 2.214  
Difference value curves ..... 2.339  
Differences to IEC/IEEE-Bus Remote Control (B10) ..... 3.341  
Differences to remote control via IEC/IEEE bus (RS-232)  
    ..... 3.364  
DIG INP AMP ..... 2.166, 2.235  
DIG OUT AMP ..... 2.170  
DIGI – ANLG ..... 2.297  
DIGI – DIGI ..... 2.297  
DIGITAL ..... 2.65  
Digital generator ..... 2.71  
DIN 45403 ..... 2.114  
DIN 45507 standard W&F ..... 2.217  
DIN/IEC ..... 2.217  
DIN-IEC 268-3 ..... 2.114

Directories ..... 2.37  
Directory structure ..... 1.9  
Display ..... 2.7, 2.327  
DISPLAY key ..... 2.3  
Display modes  
    Switchover using the mouse ..... 2.29  
Display of lists ..... 2.344  
Display of lists parameters ..... 2.344  
Display of traces and spectra ..... 2.330, 2.337  
Distant interferences suppression ..... 2.222  
Distortion measurement ..... 2.165  
Distortion measurement THD+N/SINAD ..... 2.203  
Distortion measurements THD ..... 2.199  
Distribution  
    function ..... 2.86  
    noise ..... 2.122  
Dither ..... 2.85, 2.86, 2.99, 2.101, 2.111, 2.114, 2.128  
Dolby Digital ..... 2.135  
Domain ..... 2.117  
DOS operating system ..... 2.53  
Double cross ..... 3.15  
Drive ..... 2.38  
drivername ..... 2.373  
DUAL FILE ..... 2.302, 2.330, 2.331, 2.344  
Dual trac ..... 2.302  
Dwell ..... 2.94, 2.389  
    file ..... 2.94  
    time ..... 2.94  
    value ..... 2.94  
DWELL FILE ..... 2.94  
Dwell time ..... 2.304  
Dwell time printout ..... 2.389  
DWELL VALUE ..... 2.94, 2.304  
Dyn Mode ..... 2.201, 2.205, 2.206, 2.213, 2.215  
Dynamic  
    offset calibration ..... 2.399  
Dynamic ..... 2.201, 2.205, 2.215  
Dynamic Mode ..... 2.213  
Dynamic Mode PRECISION ..... 2.399

## E

EDG TRG CH1 ..... 2.161  
EDG TRG CH2 ..... 2.161  
Editing files and directories ..... 2.321  
EMC problems ..... 2.154  
ENABLE register ..... 3.26  
ENHANCED ..... 2.78  
ENTER ..... 2.5, 2.13, 2.16, 2.34, 2.35  
Entering a new file name ..... 2.37  
Entering file names ..... 2.36, 2.37  
Entry of amplitude  
    RANDOM (noise) ..... 2.125  
    SINE ..... 2.141  
Entry of data ..... 2.34  
Entry of figures ..... 2.31  
Entry of values  
    brief introduction ..... 2.14  
Epilog for HPGL ..... 2.294  
EQUAL A ..... 2.332  
EQUAL L ..... 2.81  
EQUAL VOLT ..... 2.102  
Equal. file ..... 2.88, 2.99, 2.102, 2.106, 2.114, 2.120  
    ..... 2.130, 2.211, 2.225  
Equalization ..... 2.304  
Equalization ..... 2.389  
Equalization data ..... 2.302

- Equalization file ..... 2.304  
 equalization of analyzer signal ..... 2.210, 2.225  
 equalization of generator signals ..... 2.88  
 EQUALIZATN ..... 2.389  
 EQUALIZATN ..... 2.304  
 Equalizer ..... 2.88, 2.99, 2.102, 2.106, 2.114, 2.120  
     ..... 2.130, 2.210, 2.225  
 equalizer file, generation ..... 2.211, 2.225  
 Equalizer file, generator ..... 2.88  
 Equalizer table printout ..... 2.389  
 Equivalent ..... 2.122  
 Error messages ..... 2.51, 2.53  
     DFD measurement ..... 2.214  
     during program run ..... 2.53  
     Fatal ..... 2.54  
     MOD DIST measurement ..... 2.212  
     THD+N/SINAD measurement ..... 2.203  
 Error Messages  
     IEC/IEEE bus ..... 3.296  
 Error messages during measurement ..... 2.53  
 Error queue ..... 3.35  
 ESE (event status enable register) ..... 3.29  
 ESR (event status register) ..... 3.29  
 EVENT register ..... 3.26  
 Examples of application  
     external sweep with settling process ..... 2.48  
     quantising noise measurement ..... 2.175  
     Settling by arithmetic averaging ..... 2.42  
 Exec macro ..... 2.407  
 Explanations of Front- and Rearpanel Views ..... 2.3  
 EXPONENTIAL ..... 2.42, 2.175, 2.223  
 EXPORT ..... 2.305  
 Extension of file names ..... 2.294  
 Extern disp ..... 2.394  
 External  
     sweep ..... 2.159  
 external clock ..... 2.73  
 External Keyboard ..... 2.3
- F**
- Factor ..... 2.192, 2.249  
 FALLING ..... 2.232  
 FAST ..... 2.193, 2.206, 2.238, 2.250  
     analyzer ..... 2.201, 2.205, 2.213, 2.215  
 FAST DECAY ..... 2.254  
 Fast Fourier Transformation ..... 2.220  
 Fast frequency response measurement ..... 2.271  
 Fatal error  
     with error message ..... 2.53  
     without error message ..... 2.54  
 FDAS ..... 2.292  
 FFT ..... 2.101, 2.118, 2.165, 2.220, 2.278  
     amplitude accuracy ..... 2.226  
     frequency measurement ..... 2.226  
     implementation ..... 2.227  
     POST FFT ..... 2.172  
     Resolution ..... 2.173  
     Round noise ..... 2.226  
     Size ..... 2.173, 2.209  
     undersampling ..... 2.226  
     Window ..... 2.173  
 FFT ..... 2.15  
 FFT Size ..... 2.218, 2.221, 2.245  
 File  
     short form ..... 2.284  
 FILE ..... 2.3, 2.79, 2.81, 2.331, 2.332, 2.344, 2.354  
 FILE + AES3 ..... 2.79, 2.81  
 FILE + CRC ..... 2.79, 2.81  
 File attributes ..... 2.300  
 FILE DEF ..... 2.82, 2.374  
 File extensions ..... 2.294  
 File extensions ..... 2.321  
 FILE INTERN ..... 2.333  
 FILE NAME ..... 2.344  
 FILE panel ..... 2.294  
 File selection ..... 2.37  
 FILE/EPS ..... 2.372  
 FILE/HPGL ..... 2.372  
 FILE/PCX ..... 2.372  
 FILE/PS ..... 2.372  
 File-defined filter ..... 2.292  
 Filename ..... 2.36, 2.80, 2.81, 2.82, 2.125, 2.190, 2.301  
     ..... 2.306, 2.331, 2.351, 2.378  
 FILENAME RMS-sel. sweep ..... 2.191  
 Filter ..... 2.182, 2.194, 2.197, 2.208, 2.221, 2.229  
     ..... 2.232, 2.251, 2.254, 2.258, 2.278, 2.286, 2.287, 2.289  
     attenuation ..... 2.284  
     parameters ..... 2.291  
 FILTER ..... 2.172, 2.290  
 FILTER key ..... 2.3  
 Filter simulation ..... 2.229  
 FILTER SIMULATION ..... 2.165  
 First steps (readout of measurement results) ..... 3.340  
 First steps (readout of measurement results) (RS-232) .. 3.358  
 FIX 1000 MS ..... 2.197  
 FIX 200 MS ..... 2.197, 2.198  
 FIX 3 SEC ..... 2.197  
 FIX 50 MS ..... 2.197  
 FIX Range  
     Analyzer ..... 2.149  
     generator ..... 2.67  
 FIX: ..... 2.191  
 FLAT ..... 2.42, 2.175  
 FLAT TOP ..... 2.245  
 FLAT\_TOP ..... 2.222  
 FLOAT ..... 2.148  
 Floating inputs ..... 2.151  
 Floating reference values ..... 2.268  
 FM ..... 2.132  
 FNCT Ch1 ..... 2.262  
 FNCT Ch1&2 ..... 2.262  
 FNCT Ch2 ..... 2.262  
 Fnct Settl ..... 2.175, 2.182, 2.194, 2.197, 2.198  
     ..... 2.202, 2.208, 2.213, 2.215, 2.218  
 FOREVER ..... 2.254  
 Format ..... 2.135, 2.305, 2.354  
 Format Pha ..... 2.241  
 FrameCol ..... 2.374  
 FREQ ..... 2.95, 2.117  
 Freq Ch1 ..... 2.129  
 FREQ CH1 ..... 2.160, 2.191, 2.330, 2.344, 2.347  
 FREQ Ch1&2 ..... 2.128  
 Freq Ch2 ..... 2.129  
 FREQ CH2 ..... 2.160, 2.191, 2.330, 2.344, 2.347  
 FREQ FILE ..... 2.97, 2.141  
 Freq Mode ..... 2.128  
 FREQ MODE ..... 2.191, 2.249  
 FREQ MODE RMS sel. Sweep ..... 2.191  
 Freq No (i) ..... 2.103  
 Freq Settl ..... 2.175, 2.239, 2.242, 2.243  
 FREQ&PHASE ..... 2.128

- Frequency ..... 2.106, 2.109, 2.129, 2.135, 2.139, 2.140  
     difference ..... 2.115  
     generator ..... 2.99  
     Offset ..... 2.111  
     results ..... 2.59  
     units ..... 2.59  
 FREQUENCY ..... 2.136, 2.137  
 Frequency and phase measurement ..... 2.237  
 Frequency entry  
     SINE ..... 2.129, 2.139, 2.140  
 Frequency input  
     SINE ..... 2.99  
 frequency measurement  
     fast ..... 2.178  
 Frequency measurement ..... 2.237  
 Frequency measurement time ..... 2.238  
 Frequency measurement with FFT ..... 2.226  
 Frequency modulation ..... 2.132  
 Frequency response measurement  
     fast ..... 2.271  
 Frequency response measurement ..... 2.15  
 Frequency shift keying ..... 2.85  
 Frequency Sweep RMS sel ..... 2.187  
 Frequency units  
     reference value ..... 2.67, 2.75  
 Frequency, Phase and Group Delay ..... 2.240  
 Frequenzeingabe  
     SINE ..... 2.129  
 Front-panel ..... 2.3  
 FRQ FST CH1 ..... 2.160  
 FRQ FST CH2 ..... 2.160  
 Frq lim Low ..... 2.255  
 Frq Lim Low ..... 2.258  
 Frq lim Upp ..... 2.255  
 Frq Lim Upp ..... 2.259  
 Frq Offset ..... 2.86, 2.99, 2.111, 2.114, 2.128  
 FrqLim Low ..... 2.208, 2.251  
 FrqLim Upp ..... 2.208, 2.251  
 FSK ..... 2.85  
 Full scale value ..... 2.58  
 Full screen mode ..... 2.32, 2.29, 2.30  
 full-screen mode 3-panel display key ..... 2.32  
 FUNC CH1 ..... 2.330, 2.344, 2.347  
 FUNC CH2 ..... 2.330, 2.344, 2.347  
 Function  
     analyzer ..... 2.165, 2.166  
     generator ..... 2.85  
 FUNCTION  
     Generator ..... 2.85  
 Functions  
     changing of ..... 2.34  
 Functions of softkey ..... 2.341  
 Fundamental ..... 2.203  
 Fundamental frequency ..... 2.203  
 Fundamentl ..... 2.202, 2.207  
 Fuses ..... 1.2
- G**  
 Gain factor ..... 2.174  
     for notch filters ..... 2.174  
     MULTISINE ..... 2.104  
 GAUSS ..... 2.122  
 Gaussian distribution ..... 2.86  
 GEN CLK ..... 2.72, 2.74, 2.155  
 GEN CROSSED ..... 2.148  
 GEN key ..... 2.64  
 GEN key ..... 2.3
- GEN MLTSINE ..... 2.188  
 GEN TRACK ..... 2.170, 2.171, 2.174, 2.191, 2.202  
     2.207, 2.248, 2.249, 2.333  
 GEN1 ..... 2.148  
 GEN2 ..... 2.148  
 General Instructions for Use ..... 2.29  
 Generating a  
     sweep list ..... 2.303  
 Generation of a sweep list ..... 2.303  
 Generation of an  
     sweep list ..... 2.175  
 Generator  
     analog ..... 2.139  
     channels ..... 2.66  
     common parameters ..... 2.86  
     configuration ..... 2.66  
     frequency offset ..... 2.86  
     functions ..... 2.85  
     instruments ..... 2.65  
     settings ..... 2.17  
     signal functions ..... 2.85  
     sweeps ..... 2.91  
 GENERATOR ..... 2.64  
 Generator source impedance ..... 2.66  
 Generator sweep  
     linear step size ..... 2.96  
 Generator tracking  
     fundamental THD ..... 2.202  
     linearity measurement ..... 2.268  
     Notch filter frequency ..... 2.174  
 GENTRACK  
     RMS measurement speed ..... 2.185  
     RMS measuring speed ..... 2.180  
 Gibb's phenomenon ..... 2.196  
 GRAPH ..... 2.3, 2.32  
 Graphic Display  
     Colour Selection ..... 2.395  
 Graphic window ..... 2.31  
 Graphical data presentation ..... 2.327  
 Graphical display  
     MOD DIST measurement ..... 2.213  
     THD measurement ..... 2.202  
 GROUND  
     analyzer ..... 2.148  
 Group delay ..... 2.144  
 GROUP DELAY ..... 2.331, 2.344, 2.347  
 Group of scans ..... 2.326  
 Group of traces ..... 2.303, 2.330  
 group-delay measurement ..... 2.233
- H**  
 H COPY key ..... 2.5, 2.371  
 HAMMING ..... 2.222, 2.245  
 Handshake ..... 2.392  
 HANN ..... 2.222, 2.245  
 Hard copy ..... 2.371  
 Hard copy of screen ..... 2.5  
 Hardcopy  
     PCX Images ..... 2.298  
 hardware options ..... 2.401  
 HARM ..... 2.343  
 Harmonics ..... 2.200  
 HCOPY key ..... 2.298  
 Header ..... 3.7  
 Headphone/Speaker output ..... 2.260  
 Headphones ..... 2.260  
 help ..... 2.15

- Help ..... 2.15  
   functions ..... 2.55  
   texts ..... 2.55  
 Help during entry ..... 2.36  
 Help for graphics softkeys ..... 2.55  
 Help functions ..... 2.393  
 HELP key ..... 2.7  
 HEX ..... 2.354  
 Hex display of measurement results ..... 2.58  
 High level time for SINE BURST ..... 2.108  
 HIGH PASS ..... 2.286  
 Highpass filter ..... 2.286  
 Histogram  
   DFD ..... 2.215  
   MODDIST ..... 2.213  
   THD ..... 2.199  
 HLINE ..... 2.340, 2.341  
 HOLD ..... 2.330, 2.333, 2.344  
 Hold time ..... 2.254  
 HPGL data ..... 2.372
- I**
- IEC 118 ..... 2.115  
 IEC 268 ..... 2.115  
 IEC 386 standard W&F ..... 2.217  
 IEC 61937 ..... 2.134  
 IEC Adr ..... 2.379  
 IEC BUS ..... 2.379, 2.390  
 IEC TUNER ..... 2.208  
 IEC/IEEE bus  
   address ..... 3.4  
   connection ..... 2.408  
   interface ..... 3.293  
   functions ..... 3.294  
   messages ..... 3.295  
 IEC/IEEE-bus  
   address ..... 2.390  
 IEC/IEEE-bus control ..... 3.345  
 IEC/IEEE-bus interface ..... 2.390  
 IMAX A ..... 2.343  
 IMAX B ..... 2.343  
 Impedance  
   analyzer ..... 2.148  
 Implementing the FFT ..... 2.227  
 Info Disp ..... 2.300  
 Info Text ..... 2.300  
 INP RMS CH1 ..... 2.330  
 INP RMS CH2 ..... 2.330  
 Input ..... 2.148, 2.154  
   analyzer ..... 2.148  
   channels ..... 2.146  
   generator ..... 2.66  
   impedance ..... 2.148  
 INPUT Ch1 ..... 2.262  
 INPUT Ch1&2 ..... 2.262  
 INPUT Ch2 ..... 2.262  
 INPUT COMMON ..... 2.262  
 Input connectors of analyzers  
   analog ..... 2.9  
   digital ..... 2.9  
 INPUT DISP ..... 2.235  
   DIGital INPut AMPlitude ..... 2.236  
   PEAK ..... 2.236  
   PHASE ..... 2.235  
   PHASe TO REF ..... 2.236  
   RMS ..... 2.236  
 Input during a measurement, data output ..... 2.39  
 Input interface ..... 2.154  
 INPUT JITTER ..... 2.262  
 input peak value ..... 2.235  
 Input unit (IEC/IEEE-bus) ..... 3.18  
 INPUT/PHAS ..... 2.235  
   PHASE ..... 2.235  
 INPUT? - Press SHOW I/O ..... 2.53  
 Installation  
   hardware options ..... 1.5  
   MS-DOS operating system ..... 1.8  
   software options ..... 1.5  
   UPL operating and measurement software ..... 1.8  
   UPL software ..... 1.8  
 Installation der UPL-Bedien- und Meßsoftware ..... 1.9  
 Instructions for Use, General ..... 2.29  
 Instrument  
   change ..... 2.33  
 Instrument model (IEC/IEEE-bus) ..... 3.18  
 Instrument status, loading and storing ..... 2.296  
 Integration effect ..... 2.198  
 Integration time ..... 2.181  
 Interchannel delay ..... 2.220  
 Interface functions ..... 3.294  
 Interface message  
   DCL ..... 3.18  
   GET ..... 3.19  
   LLO ..... 3.5  
 Interface messages ..... 3.295  
 Interfaces  
   COM1, COM2 ..... 2.408  
   RS-232 ..... 2.408  
 Interference level  
   measurement results ..... 2.59  
   units ..... 2.59  
 Interfering  
   frequency ..... 2.112  
   signal ..... 2.111  
   sinewave signal ..... 2.212  
 Intermodulation  
   components ..... 2.214  
 Intermodulation measurement  
   DFD ..... 2.214  
   MOD DIST ..... 2.212  
 Intermodulation product ..... 2.212  
 INTERN ..... 2.154  
 INTERN ONLY ..... 2.394  
 Internal  
   signal connection analyzer - generator ..... 2.148  
 Internal signal paths ..... 2.151  
 Interpol ..... 2.233  
 Interpolated maximum ..... 2.343  
 Interpolated values ..... 2.337  
 Interpolation steps ..... 2.233  
 Interpolation to a common X Axis ..... 2.325  
 Interpretation file for channel status data ..... 2.354  
 Interpretation file for user data ..... 2.355  
 Interpretation mode ..... 2.354  
 INTERVAL ..... 2.90, 2.95, 2.105, 2.108, 2.110, 2.123, 2.126  
 Interval for SINE BURST  
   monitoring interval ..... 2.196  
   Monitoring interval for peak value detection ..... 2.197  
 interval length ..... 2.90  
 Interval time ..... 2.95, 2.197  
 Interval time ..... 2.95  
 Introduction  
   operation UPL ..... 2.15  
 INTV FILE ..... 2.98  
 Intv Time ..... 2.197  
 Invert1/n ..... 2.306  
 IST flag ..... 3.29



## J

JIS standard W&F .....	2.217
JITTER .....	2.71, 2.138
Jitter Freq .....	2.140
Jitter Peak Ampl .....	2.140
Jitter Ref .....	2.155
JITTER/PHAS .....	2.71, 2.153

## K

KAISER .....	2.222
KEEP .....	2.341
Key	
[LOCAL]	
lock .....	3.5
DISPLAY .....	2.327
FILE .....	2.294
GRAPH .....	2.32
H COPY .....	2.371
OFF LCD .....	2.394
OPTIONS .....	2.381
OUTPUT OFF .....	2.371
SHOW I/O .....	2.370
STATUS .....	2.293
STOP CONT .....	2.370
Key combinations	
ALT .....	2.31
Ctrl D .....	2.394
of external keyboard .....	2.3, 2.32
Keyboard settings .....	2.393
Keys of the front panel .....	2.5, 2.31
Keys, front panel	
ANLR .....	2.278
GEN .....	2.64
TAB .....	2.64, 2.142, 2.278
Keyword	
form .....	3.8
Keywords of the protocol file .....	2.354

## L

L 448 kb/s .....	2.135
LANDSCAPE .....	2.376
Language .....	2.393
Language of help texts .....	2.393
LCD .....	2.7
Contrast .....	2.394
LED	
REM .....	3.4
Left .....	2.336
Left Mrgn .....	2.375
LEFT/BOTTOM .....	2.348
Legend of graphic symbols .....	2.1
LEV all di .....	2.200
LEV even di .....	2.200
LEV odd di .....	2.200
LEV SEL di .....	2.200
LEV TRG CH1 .....	2.161
LEV TRG CH2 .....	2.161
Level	
ratio .....	2.113
Level control monitor output .....	2.260
Level entry	
Coded Audio .....	2.137

## Level measurement

DC .....	2.198
PEAK .....	2.196
QUASI-PEAK .....	2.196
RMS .....	2.178
RMS SELECT .....	2.184
LEVEL NOISE .....	2.205
LEVEL THDN .....	2.205
Level units .....	2.58
LFE 448 kb/s .....	2.135
LIM LOW&UP .....	2.350
LIM LOWER .....	2.389
Lim Lower .....	2.350
LIM LOWER .....	2.304, 2.350
LIM REPORT .....	2.389
Lim Upper .....	2.350
LIM UPPER .....	2.304, 2.350, 2.389
Limit	
check .....	2.318, 2.319, 2.337, 3.349, 2.350, 3.19
curve .....	2.350
over/underrange .....	2.317
violation .....	2.318
Limit curve	
printing .....	2.389
storing .....	2.304
value .....	2.326
Limit curve .....	2.350
Limit exceeded .....	2.350
Limit exceeded, printout .....	2.389
Limit files	
editing .....	2.312
generated from trace file .....	2.314
generation by means of application program .....	2.317
header .....	2.312
measured values .....	2.312
Limit frequency of analyzer instruments .....	2.143
Limit frequency/cutoff frequency	
FFT frequency measurement .....	2.237
Limit report list .....	2.317
Limit value .....	2.351
LIN .....	2.348
LIN POINTS	
Analysator .....	2.189
generator .....	2.96
LIN Spacing .....	2.335
LIN STEPS .....	2.189
generator .....	2.96
Line .....	2.398
Line Count .....	2.253
Line diagram .....	2.327
Linear step size	
generator sweep .....	2.96
Linearity Measurements .....	2.268
List sweep .....	2.91
buffers .....	2.91
generator .....	2.91, 2.93
storing .....	2.303
LLO .....	3.5
LOAD INSTRUMENT .....	2.296
Loading	
and Storing .....	2.294
files .....	2.294
instrument setups .....	2.296
Loading of setups .....	2.299
Loading the default setup .....	2.15
LOCAL .....	2.7
Local timecode and CRC .....	2.79
lock error .....	2.365
LOG .....	2.348
LOG POINTS	
analyzer .....	2.189

- generator..... 2.96
- LOG Spacing..... 2.335
- LOG STEPS
  - analyzer..... 2.189
  - generator..... 2.96
- Logarithmic step size
  - generator sweep..... 2.96
  - RMS sel. sweep..... 2.189
- LONG CABLE..... 2.72
- Long form (command)..... 3.8
- Loudspeaker..... 2.260
- Loudspeaker Measurements..... 2.246
- Low Dist..... 2.99, 2.399
- low frequency enhancement..... 2.135
- Low Level..... 2.107
- Low level time for SINE BURST..... 2.107
- LOW PASS..... 2.286
- Low-distortion generator..... 2.109
- Low-distortion generator..... 2.203
- Lower case (command)..... 3.37
- Lower Freq..... 2.121
- LOWER FREQ..... 2.112
- Lower frequency limit..... 2.153
- Lower frequency range limit..... 2.146
- LOWER:..... 2.149
- Lowpass filter..... 2.286
- LPT1..... 2.379
- LS 448 kb/s..... 2.135
  
- M**
- Mainlobe..... 2.222
- MANU LIST
  - Generator-Sweep..... 2.93
- MANU LIST..... 2.188
- MANU SWEEP
  - analyzer..... 2.188
  - Generator-Sweep..... 2.93
- MANUAL..... 2.335, 2.348, 2.397
- Manual control..... 3.5
- Manual Operation..... 2.1
- Manual sweeps
  - generator..... 2.93
  - operation..... 2.360
- MARKER..... 2.341, 2.342, 2.343
- Marks comment lines..... 2.322
- MAX..... 2.332, 2.334, 2.345, 2.347
- Max hold..... 2.254
- Max Hold..... 2.257
- MAX HOLD..... 2.328
- Max Volt..... 2.67, 2.75
- Maximum of measurement series..... 2.343
- Maximum peak value..... 2.165
- Maximum values bargraph..... 2.349
- MD5-Signaturverfahren (RS232)..... 3.364
- MEAN FREQ..... 2.115, 2.121
- MEAS CH1..... 2.170, 2.171, 2.333
- MEAS CH2..... 2.170, 2.171, 2.333
- Meas Disp..... 2.394
- Meas Mode..... 2.153, 2.196, 2.200, 2.205, 2.215
- Meas time..... 2.238, 2.248, 2.253
- Meas Time..... 2.179, 2.180, 2.185, 2.198, 2.206, 2.224, 2.257
  - RMS measurement..... 2.179
  - RMS SELECT measurement..... 2.185
- Measured value
  - buffer..... 2.160
  - stabilization..... 2.41, 2.47, 2.1772, 177
- Measured value and status displays..... 2.394
- Measured value resolution..... 2.45, 2.176
- Measurement
  - range selection..... 2.149
- Measurement Display
  - ON/OFF..... 2.394
  - Readin Rate..... 2.395
  - Reading Resolution..... 2.395
- Measurement function
  - reference values..... 2.169
- Measurement range..... 2.150
- Measurement range limit
  - analyzer instruments..... 2.143
  - lower..... 2.146
  - upper..... 2.143
- Measurement rate..... 2.179, 2.185
- Measurement results, display window..... 2.40
- Measurement time..... 2.253, 2.257
- Measurement valid/invalid..... 2.39
- Measurement, input during..... 2.39
- Measurements..... 2.358
- Measuring..... 2.299
- Measuring time..... 2.179, 2.185
- Measuring time FFT..... 2.227
- Memory expansion..... 4.4, 4.5
- Messages on operating state..... 2.51
- Meßzeit..... 2.257
- Min Freq..... 2.146, 2.153
- Min VOLT..... 2.163
- Minimum value of resolution during settling..... 2.45
- Minimum voltage..... 2.163
- Mod Depth..... 2.132
- MOD DIST
  - analyzer..... 2.165, 2.212
  - generator..... 2.111
  - Generator..... 2.85
- Mod Freq..... 2.89, 2.105, 2.123, 2.126, 2.132
- MODDIST signal
  - measuring on..... 2.180
- Mode..... 2.115, 2.298, 2.299, 2.330, 2.350
  - LOCAL..... 3.4
  - REMOTE..... 3.4
- Modulation
  - factor analysis..... 2.109
- MODULATION..... 2.85, 2.132
- modulation deviation
  - AM..... 2.89, 2.105, 2.123
- Modulation deviation
  - AM..... 2.126
- Modulation distortion..... 2.85
- modulation distortion
  - measurement..... 2.212
- modulation frequency
  - AM..... 2.89, 2.139
- Modulation frequency
  - AM..... 2.126
  - FM..... 2.132
- MODULATION function..... 2.89
- Modulationshub
  - AM..... 2.126
  - FM..... 2.132
- Monitor output..... 2.261
- MORE..... 2.341
- mouse
  - scrolling in the panel..... 2.32
- mouse..... 2.36
  
- Mouse
  - connection of..... 2.408
  - numeric entry..... 2.35
- mouse functions..... 2.64, 2.142, 2.278
- Mouse Operation..... 2.29
- Multichannel..... 2.135
- Multisine

dialog window ..... 2.103  
 MULTISINE ..... 2.85, 2.101

## N

NAB ..... 2.217  
 NAB standard W&F ..... 2.217  
 NARROW ..... 2.206  
 Next step ..... 2.94  
 NEXTHARM ..... 2.343  
 No of sine ..... 2.103  
 Noise  
   distribution ..... 2.122  
   spacings ..... 2.117  
   suppression (THD) ..... 2.199  
   weighting (THD+N/SINAD) ..... 2.203  
 Noise ..... 2.117  
 NOISE ..... 2.205  
 Noise component ..... 2.86  
 Nominal AC supply voltage ..... 1.1  
 NONE ..... 2.78  
 NORMAL ..... 2.182, 2.193, 2.223, 2.250  
 Normalize ..... 2.334  
 Normalized frequency response ..... 2.305  
 Normfreq ..... 2.305  
 NOT EQUAL A ..... 2.332  
 Notch ..... 2.289  
   analog filter ..... 2.174  
   characteristic ..... 2.174  
   freq ..... 2.174  
   gain ..... 2.174  
 Notch (Gain) ..... 2.174, 2.182, 2.194, 2.197, 2.221  
 NOTCH FLT ..... 2.289  
 Notch Freq ..... 2.174  
 Note on delay ..... 2.47  
 NTRansition register ..... 3.26  
 number of thirds ..... 2.253  
 Numeric values (command) ..... 3.13

## O

o CURSOR ..... 2.332, 2.334, 2.342, 2.345  
 o TO \* ..... 2.340  
 Octave ..... 2.290  
 Octave ..... 2.290  
 Octave filter ..... 2.290  
 Octave Filter ..... 2.290  
 OCTAVE FLT ..... 2.290  
 OFF LCD key ..... 2.394  
 ON TIME ..... 2.90, 2.95, 2.105, 2.108, 2.110, 2.123, 2.126  
 one-dimensional sweep ..... 2.95  
 ONTIM FILE ..... 2.98  
 Opening the instrument ..... 4.7  
 Operating mode (IEC/IEEE)  
   LOCAL ..... 3.358  
   REMOTE ..... 3.358  
 Operating states of sweep system ..... 2.363  
 Operating system level ..... 2.294  
 OPERATION ..... 2.327, 2.328, 2.352  
 OPTICAL ..... 2.154  
 OPTIMIZED ..... 2.102, 2.120  
 Optimizing  
   Frequency Response ..... 2.277  
   measurement speed ..... 2.272  
   settling parameters ..... 2.49

Option  
   Universal Sequence Controller (UPL B10) ..... 3.337  
 Options  
   enabling ..... 1.5, 1.7  
 OPTIONS key ..... 2.5  
 Order of a Filter ..... 2.286  
 Orientation ..... 2.376  
 OTHER TRACE ..... 2.333  
 Output ..... 2.7, 2.66, 2.139  
   Impedance ..... 2.66  
   power ..... 2.70  
 Output BAL ..... 2.69  
 output clock rate ..... 2.73  
 Output clock rate ..... 2.157  
 Output impedance ..... 2.139  
 Output of block data (B10) ..... 3.342  
 Output of commands  
   Output of commands ..... 3.341  
   Output of commands (B10) ..... 3.341  
 OUTPUT OFF key ..... 2.371  
 output UNBAL ..... 2.68  
 output voltage  
   bal ..... 2.75  
   unbal ..... 2.75  
 Output voltage  
   limit value ..... 2.67, 2.75  
   limitation ..... 2.75  
 Overlapping execution ..... 3.19  
 OVERlay/Max Hold ..... 2.330  
 Overloading DC measurement ..... 2.198  
 Overshoots ..... 2.196  
 Overview of measurement and sweep systems ..... 2.358

## P

PAGE ..... 2.13  
 Pair of traces ..... 2.303, 2.325, 2.330, 2.332  
 Panel ..... 2.31, 2.39, 2.79, 2.81  
   ANALYZER ..... 2.142  
   DISPLAY ..... 2.327, 2.330, 2.347  
   FILE ..... 2.294  
   FILTER ..... 2.278  
   OPTIONS ..... 2.390  
   scrolling ..... 2.32  
   STATUS ..... 2.293  
 Panel ..... 2.327  
 PANEL ..... 2.81  
 PANEL + AES 3 ..... 2.79, 2.819  
 PANEL + CRC ..... 2.79, 2.81  
 PANEL OFF ..... 2.78  
 Panel selection ..... 2.31  
 Panelfile ..... 2.83  
 Panels  
   changing ..... 2.29, 2.30  
   changing between ..... 2.31  
   changing using the keyboard ..... 2.31  
   changing using the mouse ..... 2.31  
   position on the screen ..... 2.32  
 Paper Size ..... 2.379  
 Parallel poll ..... 3.34  
 Param. Link ..... 2.403  
 Parameter (command) ..... 3.13  
 Parameter Link ..... 2.33, 2.34, 2.403  
 Parameters  
   changing ..... 2.34  
   display panel ..... 2.330, 2.347  
   list display ..... 2.344  
   selection ..... 2.34

- Parity ..... 2.391, 2.409
- Parser ..... 3.19
- Partial setup, loading and storing ..... 2.296
- Part-screen graphics ..... 2.357
- Passb Low ..... 2.287
- Passb Upp ..... 2.287
- Passband ..... 2.286
- Password protection ..... 2.402
- Path ..... 2.36
- PDF ..... 2.86, 2.99, 2.111, 2.114, 2.122, 2.128
- PEAK ..... 2.235
- PEAK & S/N ..... 2.165
- PEAK measurement ..... 2.196
- Peak value detector ..... 2.165, 2.196
- Peak weighting ..... 2.196
- Peak-to-peak amplitude
- MOD DIST ..... 2.113
  - MULTISINE ..... 2.104
  - POLARITY ..... 2.127
  - SINE ..... 2.100, 2.139, 2.140
  - SINE BURST ..... 2.107
  - SINE<sup>2</sup> BURST ..... 2.109
- Periodic tracings of measured values ..... 2.160
- PERMANENT ..... 2.263
- Permissible range of values ..... 2.36
- Phas Ch2
- 1 ..... 2.130
- Phas Settl ..... 2.175, 2.242
- PHAS TO REF ..... 2.235
- Phase
- digital ..... 2.71
  - frame (jitter) ..... 2.235
  - measurement results ..... 2.59
  - optimization ..... 2.117
  - position sine voltage with MULTISINE ..... 2.101
  - reference value ..... 2.172
  - units ..... 2.59
- PHASE ..... 2.330, 2.344, 2.347
- Frame Phase ..... 2.235
- Phase difference ..... 2.240
- phase measurement ..... 2.144
- Phase No (i) ..... 2.103
- Phase Reference value ..... 2.172
- PHASE TO REF ..... 2.166
- PhaseToRef ..... 2.400
- Phone ..... 2.263
- Phone Out ..... 2.177
- PINK ..... 2.118
- Pink noise ..... 2.118
- Plot on ..... 2.379
- Plots/Page ..... 2.380
- PLOTTR/HPGL ..... 2.372
- Points
- analyzer ..... 2.163, 2.190
  - generator ..... 2.97
- Polarity
- measurement ..... 2.219
  - Polarity measurement ..... 2.85
  - test ..... 2.127
  - Test ..... 2.219
- POLARITY ..... 2.85
- analyzer ..... 2.127
  - generator ..... 2.165
- Polarity reversal ..... 2.219
- Polarity Test ..... 2.219
- Poles ..... 2.292
- PORTRAIT ..... 2.376
- Post FFT ..... 2.183
- POST FFT ..... 2.173, 2.209
- Post FFT RMS measurement ..... 2.183
- Post-FFT ..... 2.218
- Potential reference ..... 2.149
- Power supply ..... 1.1
- PPE (parallel poll enable register) ..... 3.29
- Pre Gain ..... 2.177, 2.263
- PRECISION ..... 2.238
- analyzer ..... 2.201, 2.205, 2.213, 2.215
- Precision of frequency measurement ..... 2.238
- Preparation for use (RS232) ..... 3.357
- Print
- format ..... 2.376
- Printer
- output ..... 2.389
- PRINTER ..... 2.371
- Printing traces and lists ..... 2.389
- Printname ..... 2.373
- Printout ..... 2.376
- PRINTR/HPGL ..... 2.372
- PRINTR/PS ..... 2.372
- Pm Hight ..... 2.379
- Pm Resol ..... 2.376
- Pm Width ..... 2.379
- Program example
- Readout of results in R&S BASIC ..... 3.360
- Program examples
- Readout of Measurement results (B-10) ..... 3.340
  - Readout of measurement results in Borland-C 3.0... 3.361
  - Result readout in QuickBASIC ..... 3.359
- Programming examples ..... 3.300
- Programming model
- UPL analyzer ..... 3.17
  - UPL generator ..... 3.16
- Prolog for HPGL ..... 2.294
- PROTO AUTO ..... 2.352
- Proto File ..... 2.354, 2.355
- protocol ..... 2.78
- PROTOCOL ..... 2.78, 2.165, 2.328, 2.352
- PROTOCOL analysis ..... 2.352
- PTRansition register ..... 3.25
- Pulse duration SINE<sup>2</sup> BURST ..... 2.110
- Pulse spectrum ..... 2.222
- ## Q
- Q PK & S/N ..... 2.165
- Quantising noise measurement ..... 2.175
- Quasi-PEAK measurement ..... 2.196
- Quasi-peak weighting ..... 2.191
- Query
- form ..... 3.7
  - response ..... 3.11
- Question mark ..... 3.15

## R

- R 448 kb/s ..... 2.135
- Rackmounting..... 1.1
- RAM drive..... 1.7, 2.134
- RANDOM ..... 2.85
- Range..... 2.149
  - overranges ..... 2.51
  - rated value ..... 2.149, 2.150
  - spacing..... 2.150
  - unterranges ..... 2.51
- Ranges..... 2.150
- READ ONLY..... 2.300
- Read Rate ..... 2.395
- Read Resol..... 2.395
- READ.ME..... 1.9
- READ/WRITE..... 2.300
- Reading in responses (B10) ..... 3.341
- Reading out block data (B10) ..... 3.342
- Readout of measurement results
  - in Borland-C 3.0 ..... 3.361
  - in R&S BASIC ..... 3.360
  - Univ. Sequence Controller UPL-B10..... 3.340
- Readout of Measurement Results
  - in QuickBASIC ..... 3.359
- REAL..... 2.305
- Rear view ..... 2.10, 2.11
- RECTANGLE..... 2.86
- RECTANGULAR..... 2.222, 2.245
- Ref Freq ..... 2.67
  - Analysator ..... 2.243
  - analyzer..... 2.171, 2.239, 2.241
- Ref Frq ..... 2.75
- REF GEN ..... 2.74
- Ref Imped..... 2.146
- REF IN..... 2.72, 2.74, 2.156
- Ref Out
  - Data ..... 2.74
  - Source..... 2.74
- Ref Phase..... 2.172, 2.242
- Ref Volt..... 2.68, 2.76, 2.232
- Reference..... 2.169, 2.170, 2.181, 2.186, 2.197, 2.198, 2.201
  - ..... 2.206, 2.220, 2.236, 2.248, 2.254, 2.258, 2.332
  - ..... 2.333, 2.345, 2.347
  - impedance..... 2.146
  - point DC measurement..... 2.198
  - trace was stored in the file..... 2.333
  - traces ..... 2.332
  - traces ..... 2.302, 2.324
  - value depend..... 2.335
  - variable..... 2.302
- Reference measurement potential ..... 2.149
- Reference value
  - storage on key stroke ..... 2.172
- Reference values
  - floating..... 2.268
  - group-delay measurement..... 2.172
  - phase measurement..... 2.172
- Rejection ..... 2.206
- Release control..... 3.345
- Remote control ..... 3.1
- Remote control via RS-232 interface ..... 3.357
- Remote via ..... 2.390
- Rep delay ..... 2.393
- Rep rate..... 2.393
- Repetition delay..... 2.393
- Repetition rate ..... 2.393
- Repetitive triggering..... 2.393
- Replace
  - the SETUP battery ..... 4.8
- Resolution
  - FFT ..... 2.173, 2.210, 2.218, 2.224, 2.227, 2.245
  - Settling..... 2.50, 2.176
- Resolution value..... 2.50
- Restart
  - of a measurement ..... 2.359
  - of sweep ..... 2.160
  - of the last valid setting ..... 2.53
  - of the UPL..... 2.54
  - of the UPL with default setting ..... 2.54
- retry..... 2.410
- Return to manual operation (RS-232)..... 3.358
- RIFE-VINC 1 ..... 2.222, 2.245
- RIFE-VINC 2 ..... 2.222, 2.245
- RIFE-VINC 3 ..... 2.222, 2.245
- Right ..... 2.336
- RIGHT/TOP ..... 2.348
- Ripple..... 2.287
- RISING..... 2.232
- RMS..... 2.178, 2.235
- RMS & S/N..... 2.165
- RMS S/N ..... 2.178
- RMS SELECT ..... 2.165, 2.184
- RMS value incl. S/N ..... 2.178
- rollkey ..... 2.53
- Rotary knob..... 2.7
- Rounding noise ..... 2.227
- RS-232 interface ..... 2.390
- RS 448 kb/s ..... 2.135
- RS-232 (COM1, COM2) ..... 2.408
- RS-232 interface
  - Differences to the IEC/IEEE bus ..... 3.364
  - First steps (readout of measurement results)..... 3.358
  - Preparation for use..... 3.357
  - Return to manual operation..... 3.358
- RS-232 Interface
  - Switchover to Remote Control..... 3.358
- RTS/CTS..... 2.392
- RUB & BUZZ..... 2.165
- Rub & Buzz Measurements ..... 2.246
- Rub&Buzz ..... 2.278
- RUMBLE UNW..... 2.208
- RUMBLE WTD..... 2.208

## S

- S/N measurement ..... 2.167
- S/N Sequ..... 2.167, 2.178, 2.196
- Sample..... 2.42, 2.50
- Sample frequency
  - maximum ..... 2.157
- Sample Frequency
  - analyzer ..... 2.157
  - generator ..... 2.73
- Sample Frq
  - Analyzer..... 2.157
  - Generator..... 2.73
- Sample Mode ..... 2.405
- Sample rate
  - filter..... 2.291
- Samples ..... 2.175
- Sampling Frequency
  - Measurement..... 2.243
- Scale..... 2.335, 2.348
- Scale B ..... 2.332
- Scan conf..... 2.397
- Scan Count ..... 2.329
- Scan count =1 ..... 2.324
- Scan count >1 ..... 2.325
- Scan index ..... 2.337

Scan index.....	2.7, 2.325	Short name of filters.....	2.284
Scannr.....	2.397	Shortname.....	2.285
SCPI		SHOW I/O.....	2.5, 2.370
introduction.....	3.7	key.....	2.370
keywords.....	3.8	messages.....	2.53
SCREEN.....	2.373	SHOW I/O.....	2.40
Screen copies		Signal amplification.....	2.261
plotting.....	2.381	Signal period matching.....	2.179, 2.185
printing.....	2.381	Signal spectrum.....	2.222
storing.....	2.381	Signal-to-noise measurement.....	2.167
Scrolling in the panel.....	2.32	Signaturverfahren MD5 (RS232).....	3.364
SELECT.....	2.5, 2.16	Simulation.....	2.172, 2.278
SELECT di.....	2.200	Simulation.....	2.229
Selection		SINAD.....	2.205
commands.....	2.83	Sine.....	2.85
file.....	2.37	SINE.....	2.85, 2.89, 2.105, 2.122, 2.126
of a Parameter.....	2.34	SINE.....	2.99
Selection of analyzer.....	2.142	SINE BURST.....	2.85
Selection of function		Sine burst signal.....	2.85
brief introduction.....	2.14	SINE <sup>2</sup> BURST.....	2.85
Selection of generator.....	2.65	SINE <sup>2</sup> BURST.....	2.127
Selective rms measurement.....	2.165	SINE <sup>2</sup> BURST signal.....	2.219
Selective rms value.....	2.184	Sinewave amplitude	
SELECTP.....	2.379	MULTISINE.....	2.104
Selftest.....	1.3	SINE.....	2.100
Semicolon.....	3.15	SINE BURST.....	2.107
Sequence Control (opt. UPL B10).....	3.337	SINE <sup>2</sup> BURST.....	2.109
Sequence of operation in the panels.....	2.29, 2.30	Sinewave amplitude SINE.....	2.139, 2.140
Serial poll.....	3.34	Sinewave frequency	
Series of data.....	2.302	MULTISINE.....	2.103
Series of measured values.....	2.324	SINE BURST.....	2.106
Service functions.....	2.401	SINE <sup>2</sup> BURST.....	2.109, 2.110, 2.112, 2.113, 2.115
Service request.....	3.33	Sinewave signal.....	2.138
SET TO.....	2.340	Single	
SETREF.....	2.341, 2.343	key.....	2.160
Setting and displaying auxiliary.....	2.390	SINGLE.....	2.5
Setting parameters.....	2.13	SINGLE.....	2.363, 2.364
Setting the Display Parameters.....	2.18	SINGLE key.....	2.360
Setting, switching off the displays.....	2.394	Single measurement.....	2.5, 2.160
Settling.....	2.164, 2.175	Single measurement at fixed intervals.....	2.163
delay with external sweep		Single measurements.....	2.358
control.....	2.45	Single sine.....	2.101
resolution.....	2.45	Sinusamplitude SINE.....	2.130
introduction.....	2.41	SLOW.....	2.206
optimizing the parameters.....	2.48	SLOW DECAY.....	2.254
process		Smoothed display.....	2.233
measurement run with external sweep.....	2.47	SMPTE.....	2.111
Settling.....	2.41	SMPTE measurement procedure.....	2.212
SETTLING		Softkey menus.....	2.337
check.....	2.48	Softkeys.....	2.9, 2.35
Settling by arithmetic averaging.....	2.42	Softkeys.....	2.339
Settling condition.....	2.42	software options.....	2.401
Settling delay with external sweep.....	2.50	installing.....	1.5
Settling parameter		Software options	
optimizing.....	2.49	enabling.....	1.5
Settling parameters.....	2.42	.....	1.7
settling process		installation.....	1.5
combination.....	2.41	.....	1.7
Settling process.....	2.175	new installation of.....	1.5
possible combinations.....	2.41	.....	1.7
Settling process.....	2.41	Software Options	
Settling time		enabling.....	1.5
filter.....	2.284	source.....	2.66
Settling tolerance.....	2.42	Source.....	2.139, 2.353
SETUP.....	1.3, 2.298	Source impedance.....	2.66, 2.139
Shape.....	2.118	Source impedance.....	2.66
Shape file.....	2.119	Space.....	3.15
Shielded cables.....	2.408	Spacing.....	2.96, 2.101, 2.118, 2.189, 2.335, 2.348
Short circuit		Span.....	2.224
generator output.....	2.70	Span FFT.....	2.227
Short form (command).....	3.8	SPC LIM REP.....	2.327
		SPEAKER.....	2.177, 2.183, 2.194, 2.197, 2.198, 2.202

.....	2.213, 2.215, 2.218, 2.225, 2.229, 2.233, 2.251, 2.255	
.....	2.259, 2.262	
Speaker off.....	2.260	
SPECTR LIST.....	2.327	
SPECTRUM.....	2.328	
Spectrum Analysis.....	2.220	
SPEKER.....	2.219	
Spk Volume.....	2.177, 2.263	
Spurious emissions.....	2.408	
SRE (service request enable register).....	3.28	
SRQ (service request).....	3.33	
Standard.....	2.217	
STANDARD.....	2.231	
Standard W&F.....	2.217	
Start.....	2.163, 2.173, 2.189, 2.210, 2.218, 2.223, 2.245	
generator sweep.....	2.96	
START.....	2.5	
START COND.....	2.159, 2.160	
START COND.....	2.39	
Start condition.....	2.159	
START key.....	2.160	
START key.....	2.360, 2.363, 2.364	
Start of arithmetic averaging.....	2.42	
Start Options.....	1.10	
Start/stop limits for triggering.....	2.163	
Starting and stopping of measurements or sweeps.....	2.358	
State diagram		
measurement.....	2.359	
sweep.....	2.360	
STATIC.....	2.78	
Status		
display.....	2.117	
Status byte.....	3.28	
Status diagram		
sweep.....	2.360	
Status display		
ANL status.....	2.51	
GEN ORUN.....	2.73	
GEN status.....	2.51	
SWP status.....	2.52	
Status display.....	2.51, 2.52	
Status displays.....	2.358	
Status information.....	2.40	
STATUS key.....	2.3	
Status operation register.....	3.30	
Status panel.....	2.32	
STATUS panel.....	2.293	
Status questionable register.....	3.31	
Status register		
condition part.....	3.25	
enable part.....	3.26	
error queue.....	3.35	
event part.....	3.26	
event status enable register.....	3.29	
event status register.....	3.29	
IST flag.....	3.29	
ntransition part.....	3.26	
overview.....	3.27	
parallel poll enable register.....	3.29	
ptransition part.....	3.25	
service request enable register.....	3.28	
status byte.....	3.28	
status operation register.....	3.30	
status questionable register.....	3.31	
structure.....	3.25	
summary bit.....	3.26	
Status reporting system.....	3.24	
resetting.....	3.36	
use.....	3.33	
steady readout by settling.....	2.41	
Step		
generator.....	2.97	
RMS sel. sweep.....	2.190	
Step size		
linear generator sweep.....	2.96	
logarithmic generator sweep.....	2.96	
STEREO SINE.....	2.85, 2.128	
Stop.....	2.163, 2.173, 2.210, 2.218, 2.224, 2.245, 2.409	
generator sweep.....	2.96	
Stop.....	2.5	
STOP.....	2.358	
Stop Bits.....	2.391	
STOP CONT key.....	2.370	
STOP key.....	2.161	
STOP/CONT.....	2.5	
STOP/CONT.....	2.363, 2.364	
Stopb Low.....	2.287, 2.289	
Stopb Up.....	2.287, 2.289	
Stopband.....	2.286	
STORE.....	2.169, 2.171, 2.172, 2.303	
STORE CH1.....	2.169, 2.171	
STORE CH2.....	2.169, 2.171	
STORE INSTRUMENT.....	2.299	
STORE TRACE/LIST.....	2.303	
Store traces and sweep lists.....	2.303	
Storing complete instrument setup.....	2.299	
Storing of setups.....	2.299	
Strings.....	3.14	
Suffix, numeric.....	3.8	
Sum transfer function.....	2.229	
Summary bit.....	3.26	
SUPERFAST.....	2.206	
Superimposed sinewave voltages.....	2.101	
supplementary software		
installation.....	1.6	
sweep.....	2.399	
External.....	2.361	
frequency sweeps.....	2.361	
level sweeps.....	2.361	
level trigger.....	2.361	
Time-chart.....	2.361	
Time-tick.....	2.361	
Sweep		
automatic lists-.....	2.188	
direction.....	2.96	
frequency of selective rms measurement.....	2.187	
lists RMS sel. sweep.....	2.191	
manual lists.....	2.188	
one-dimensional.....	2.91	
steps are skipped.....	2.94	
stop.....	2.5	
two-dimensional.....	2.91	
Sweep.....	2.358	
Sweep Control.....	2.93	
SWEEP CTRL2.99, 2.106, 2.109, 2.111, 2.115, 2.129, 2.133, 2.136, 2.141, 2.187, 2.188		
sweep direction.....	2.96	
SWEEP LIST.....	2.327, 2.330	
Sweep Mode.....	2.182, 2.193, 2.250	
Sweep parameter		
X axis).....	2.95	
Sweeps		
analyzer.....	2.187	
generator.....	2.91	
Switching off.....	1.4	
Switching on.....	1.3	
Switching on the UPL.....	2.13	
Switching sweeps on and off.....	2.362	
Switchover to Remote Control (RS232).....	3.358	
Switchover to UPL user interface.....	3.343	
SWP CONT RUNNING.....	2.363	
SWP INVALID.....	2.363	
SWP LIM REP.....	2.327	
SWP MANU RUNNING.....	2.363	

- SWP OFF ..... 2.363  
 SWP SNGL RUNNING ..... 2.363  
 SWP STOPPED ..... 2.363  
 SWP TERMINATED ..... 2.363  
 SYNC IN ..... 2.72  
 Sync Mode ..... 2.72  
 Sync Out  
   Source ..... 2.74  
   Type ..... 2.74  
 SYNC PLL ..... 2.74  
 Sync To  
   analyzer ..... 2.156  
   generator ..... 2.72  
 SYNC TO ANALYZER ..... 2.73  
 Synchronization (command) ..... 3.21  
 Syntax elements (command) ..... 3.15  
 SYSTEM ..... 2.5, 2.412  
 System files ..... 2.294  
 SYSTEM key ..... 2.233
- T**
- Test signal  
   intermodulation measurement ..... 2.111, 2.114  
   polarity measurement ..... 2.127  
 Text commands ..... 2.84  
 THD ..... 2.165  
 THD measurement ..... 2.199  
 THD+N ..... 2.205  
 THD+N / SINAD measurement ..... 2.208  
 THD+N/SINAD ..... 2.165  
 THD+N/SINAD measurement ..... 2.203  
 third analysis  
   lower band limit ..... 2.255  
   upper band limit ..... 2.255  
 Third analysis ..... 3.333  
 Third Analysis ..... 2.252  
 THIRD OCT ..... 2.118  
 Third Octave ..... 2.278  
 Third-octave ..... 2.290  
 Third-octave Filter ..... 2.290  
 Third-octave noise ..... 2.118  
 Time ..... 2.117, 2.162  
 TIME CHART ..... 2.160  
 Time domain display ..... 2.230  
 TIME TICK ..... 2.160  
 Timeout ..... 2.50, 2.177  
 Tolerance ..... 2.176  
 Tolerance ..... 2.50  
 Tolerance band ..... 2.42  
 TOP ..... 2.335  
 TOSLINK ..... 2.154  
 Total Gain factor ..... 2.104  
 Total Peak ..... 2.104  
 Total RMS ..... 2.105  
 TOTAL VOLT ..... 2.113, 2.116  
 TRACE A ..... 2.303, 2.305, 2.330, 2.344, 2.350, 2.389  
 TRACE A + B ..... 2.350, 2.389  
 Trace and spectrum display ..... 2.337  
 TRACE B ..... 2.303, 2.305, 2.330, 2.344, 2.350, 2.389  
 Trace data storing ..... 2.303  
 Trace Len ..... 2.233  
 Trace length ..... 2.233  
 Trace length of the signal ..... 2.233  
 Trace printout ..... 2.389  
 TRACEA ..... 2.341  
 TRACEB ..... 2.341  
 Traces ..... 2.302
- Traces to be used ..... 2.337  
 Tracing of measured values  
   continuous ..... 2.160  
   due to frequency change ..... 2.160  
   due to voltage change ..... 2.160  
   fixed number ..... 2.163  
   fixed time interval ..... 2.163  
 Tracing of measured values at regular intervals ..... 2.160  
 Transfer function ..... 2.292  
 Transfer Function ..... 2.244  
 Transfer of parameters ..... 2.403  
 Triangle ..... 2.86, 2.122  
 Triangular distribution ..... 2.86  
 Trig Chan ..... 2.233  
 Trig Level ..... 2.183, 2.232  
 Trig Slope ..... 2.232  
 Trigger  
   Waveform ..... 2.230  
 Trigger ..... 2.159  
 Trigger condition for tracing measured values ..... 2.159  
 Trigger event ..... 2.160  
 trigger source ..... 2.233  
 TRIGGERED  
   RMS measurement ..... 2.180  
 True rms measurement ..... 2.165, 2.178  
 twelfth analysis  
   lower band limit ..... 2.258  
   upper band limit ..... 2.259  
 Twelfth Analysis ..... 2.256  
 two-dimensional sweep ..... 2.295  
 Two-tone signal to SMPTE ..... 2.111  
 Type ..... 2.389
- U**
- UNBAL  
   Generator ..... 2.66, 2.139  
 UNBAL BNC  
   analyzer ..... 2.154  
 Unbal Out ..... 2.71  
 Unbalanced output ..... 2.68  
 Unbalanced output (Output UNBAL, BNC) ..... 2.69  
 UNDERSAMPLE ..... 2.231  
 Undersampling FFT ..... 2.226  
 UNDO ..... 2.341  
 Unit ..... 2.168, 2.201, 2.206, 2.213, 2.215, 2.218, 2.232  
   ..... 2.245, 2.332  
 UNIT ..... 2.344, 2.347  
 Unit Ch1 ..... 2.168, 2.181, 2.186, 2.197, 2.198, 2.220  
   ..... 2.236, 2.239, 2.241, 2.243, 2.248, 2.254, 2.258  
 Unit Ch2 ..... 2.168, 2.181, 2.186, 2.197, 2.198, 2.220  
   ..... 2.236, 2.239, 2.241, 2.243, 2.248, 2.254, 2.258  
 Unit/Label ..... 2.332  
 Units  
   conversion formulas for entry of values ..... 2.61  
   conversion formulas ..... 2.57  
   display of measurement results ..... 2.57  
   for measurement results ..... 2.57  
   for value inputs ..... 2.57  
   function labelling ..... 2.329  
   IEC-bus notation ..... 2.59  
   list of all ..... 2.57  
   measurement result output ..... 2.168  
   of measurement results ..... 2.168  
   output of measurement result ..... 2.239  
   result display ..... 2.241
- Universal Sequence Controller



Switchover to UPL.....	3.343
Universal Sequence Controller (UPL B10).....	3.337
Universal Sequence Controller UPL-B10.....	3.337
Differences to IEC/IEEE-bus Control.....	3.341
First steps (readout of measurement results).....	3.340
Output of block data.....	3.342
Reading in responses.....	3.341
Reading out Block data.....	3.342
UNZOOM.....	2.341
UPL IEC adr.....	2.390
UPL software	
command line options.....	1.11
command line parameters at power-up.....	1.13
integration of programs.....	1.10
restarting.....	1.10
UPL-B1.....	2.401
UPL-B10.....	1.5, 2.401
UPL-B10 Universal sequence controller.....	3.337
UPL-B2.....	2.401
UPL-B21.....	1.5, 2.78, 2.401
UPL-B22.....	1.5, 2.401
UPL-B23.....	1.5, 1.7, 2.85, 2.134, 2.401
UPL-B29.....	2.401
UPL-B33.....	1.5, 2.401
UPL-B4.....	1.5, 2.401
UPL-B5.....	2.401
UPL-B6.....	1.5, 2.401
UPL-B8.....	1.5, 2.401
UPL-B9.....	1.5, 2.401
UPLCFG.....	1.13
Upper case (command).....	3.37
Upper Freq.....	2.121
UPPER FREQ.....	2.112
Useful signal.....	2.111
Useful sinewave signal.....	2.212
User data.....	2.82
USER DEF.....	2.101, 2.118, 2.297
User files.....	2.294
USER L.....	2.353
User Label.....	2.329
User Mode.....	2.82
USER R.....	2.353
User-definable filter.....	2.284
USERKEYB.BAT.....	1.10, 1.13
<b>V</b>	
Valid Chan.....	2.78
Validity bit.....	2.352
VALUE.....	2.73
Value commands.....	2.84
Value entry, rotary knob, numeric keypad.....	2.35
Value of axes, printout.....	2.389
VARI (PLL).....	2.155
Vari Mode.....	2.136
Variation.....	2.89, 2.105, 2.123, 2.126, 2.164
Variation mode.....	2.136
Variation Mode.....	2.136
Version display.....	2.401
VGA	
interface.....	2.411
monitor.....	2.394
monitor connector 15-contact.....	2.11
VGA monitor.....	2.394
VIDEO 50.....	2.72
VIDEO 60.....	2.72
VIEW OFF.....	2.342
VIEW PCX.....	2.298

Virtual Drive	
installation.....	1.7
VOLT.....	2.95
Volt Ch1.....	2.130
VOLT CH1.....	2.161
VOLT CH1&2.....	2.128
Volt Ch2.....	2.130
1.....	2.131
VOLT CH2.....	2.161
VOLT FILE.....	2.97, 2.141
VOLT LF\UF.....	2.112
Volt Mode.....	2.128
Volt No (i).....	2.104
Volt Range.....	2.67
VOLT RMS.....	2.122, 2.125
VOLT&RATIO.....	2.128
Voltage.....	2.107, 2.109, 2.127, 2.130, 2.133, 2.139, 2.140
generator.....	2.100
increase.....	2.101
range.....	2.149
sweeps.....	2.97
VOLTAGE.....	2.136, 2.137
voltage check.....	2.67
voltage limitation.....	2.67
VOLTAGE PEAK.....	2.121, 2.125
Voltage selector.....	1.1
Voltsource.....	2.305
Volume.....	2.261

## W

W&F.....	2.165
Waterfall.....	2.223
WATERFALL.....	2.328
Waveform.....	2.165
WAVEFORM.....	2.165
Waveform display.....	2.230
Ways of presentation.....	2.15
Ways of Starting the Analyzer, Ext. Sweep.....	2.159
Weighting.....	2.217
Weighting filters.....	2.279
WHITE.....	2.118, 2.374
White noise.....	2.118
WIDE.....	2.206
Width.....	2.290
Width of a Filter.....	2.289
Windo.....	2.245
Window.....	2.210, 2.218, 2.222
FFT.....	2.173
Window functions.....	2.222
Window functions of FFT.....	2.228
WORD CLK.....	2.72, 2.74
Word width	
digital generator.....	2.75
Work dir.....	2.321
working directory.....	2.296
Working Directory.....	2.38
WOW & FL.....	2.165
Wow & Flutter.....	2.217
Wow&Flutter.....	2.165
WRD CLK INV.....	2.72
Write protection.....	2.300

**X**

X AXIS.....	2.303, 2.389
X Axis (sweep) .....	2.95
X Pos.....	2.336
X scaling.....	2.376
X-axis (sweep).....	2.91
XLR output .....	2.139
XON/XOFF.....	2.392

**Y**

Y Pos.....	2.336
Y scaling.....	2.376

**Z**

Z Axis .....	2.95, 2.389
Z AXIS.....	2.303
Z sweep.....	2.91
Z-axis .....	2.91
ZERO .....	2.79, 2.81, 2.82
Zero Auto.....	2.399
Zeros .....	2.292
ZOOM.....	2.340
Zoom Fact .....	2.223
Zoom factor .....	2.223
Zooming frequency range FFT.....	2.223
Zooming zone .....	2.224
Z-parameter.....	2.91

<b>-∏</b> ... +.....	2.229
----------------------	-------

**#**

* CURSOR.....	2.314
---------------	-------

**\***

* CURSOR .....	2.312, 2.314
*CURSOR.....	2.307, 2.321

**+**

+1000 ppm.....	2.86
----------------	------

**=**

= SPEAKER.....	2.247
----------------	-------

**0**

0 dB .....	2.164
------------	-------

**1**

1/3 OCT FLT .....	2.273
1/3 OCTAVE .....	2.155, 2.240
1024 kHz.....	2.72
12 dB Auto .....	2.164
1-k block.....	2.306

**2**

2 Sigma.....	2.206
2Sigma weighting.....	2.206

**3**

30 dB Auto .....	2.164
32 kHz.....	2.73
32.0 (PLL) .....	2.145
3-panel display.....	2.29, 2.32

**4**

44.1 kHz.....	2.73
44.1 (PLL) .....	2.145
48 kHz.....	2.73
48.0 (PLL) .....	2.145